

VIKEDAL

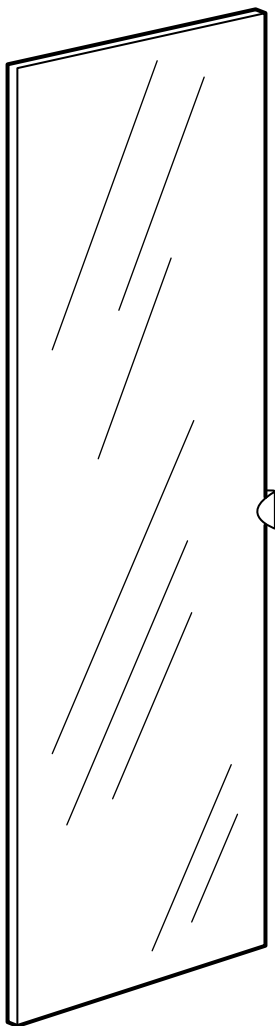

Design and Quality
IKEA of Sweden

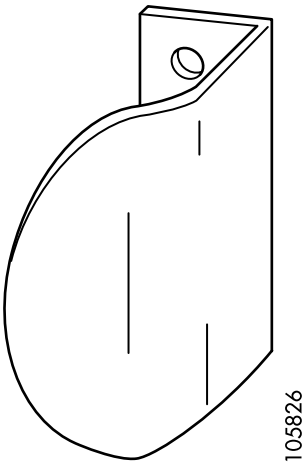
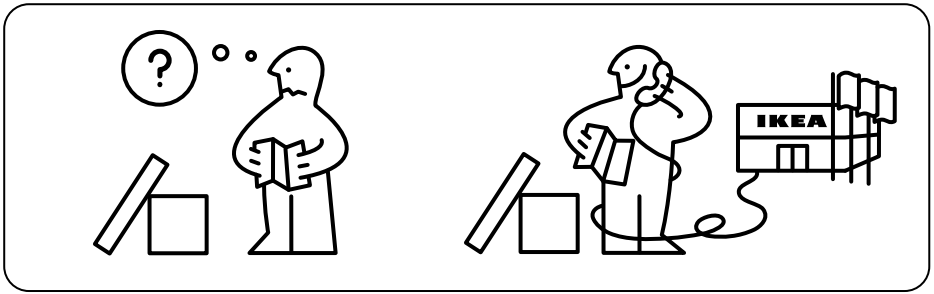
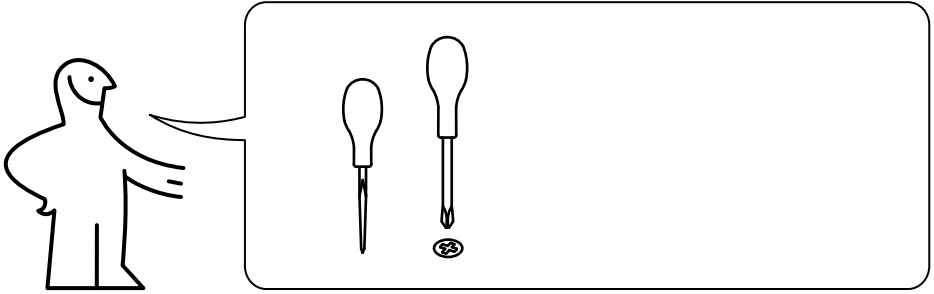

1x

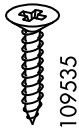

2x

1

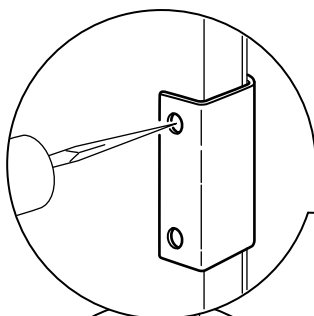
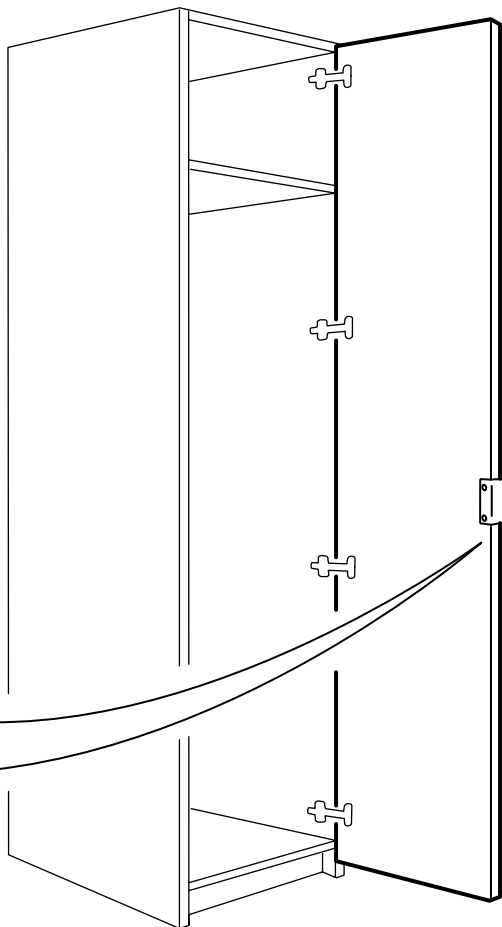

2x

