

IKEA®

Design for Everyone

NORRÅKER
chair, see pg 196

\$99

ALL CATALOGUE PRICES ARE MAXIMUM PRICES VALID UNTIL JULY 31, 2017.



Designed for people who don't always eat at the table. Easy to hold with one hand and extra durable thanks to the feldspar porcelain. Excellent to serve from, too.

01 IKEA 365+ deep plate/bowl, angled sides \$3.50.
Feldspar porcelain. Designer: Preutz/Wihlborg/Braasch/Karlsson. Ø17cm. 502.797.02



01 IKEA 365+
deep plate/bowl,
angled sides
\$3.50

The spout on VARDAGEN bowl makes a big difference. Thanks to that detail, the pancake batter will end up in the pan and not on the kitchen counter or on your socks.

03 New VARDAGEN bowl \$7.99. Glass. Designer: Preutz/Wihlborg/Braasch/Karlsson. Ø26cm. 702.892.48



03 New VARDAGEN
bowl
\$7.99

A compact table with big possibilities. Seats 1, 2, 3 or 4 people. And there's plenty of storage space in the 6 drawers. If you ask us, it's clever design at a great price.

02 NORDEN gateleg table \$299. Clear lacquered solid birch. RA. L26/89/152xW80xH74cm. 102.902.21

RA=REQUIRES ASSEMBLY

Put the powers of cooking at your fingertips



NUTID
4 element induction cooktop
\$1299

The NUTID induction cooktop puts you in control of flavour creation. Regulate the heat easily on the touch control, or use the power booster to really get cooking. Precise, energy efficient, safe and fast.

NUTID 4 element induction cooktop \$1299.
1x1400W induction zone. 1x1800W induction zone. 2x3200W induction zone with booster. Cannot be installed over an oven in the same cabinet. Designer: Mikael Warnhammar. W30³/₈x20¹/₈xH2¹/₂". 501.826.20
Shop online at [IKEA.ca](https://www.ikea.com)

At IKEA, design is about much more than how things look. It's about making things better. We call our approach "democratic design". Design that is beautiful and functional is not for the few, it is for the many.

Every year, we visit homes around the world to discover people's needs and dreams so that we can design solutions that make everyday life a little better – for everyone. For children who love to cook, for moms who want to de-clutter, and for girlfriends who enjoy breakfast in bed.

So – will you want to buy some of our products after you've read this catalogue? Hopefully. Will you look at our products a little bit differently now that you know our beliefs on design? We sure hope so.

This year marks our 40th year in Canada. Whether this is your fortieth IKEA Catalogue or your first, enjoy what's inside because it's been made with you in mind.



Dining
pg. 10

Home furnishing ideas

Rooms and spaces that inspire you with ideas and tips about how to live a better everyday life at home.

Dining	10
Kitchen	32
Relaxing	74
Organizing	100
Sleeping	124
Bathroom	146

News

Our latest products and future collections, the result of another year of endless curiosity.

News	006
Coming soon	164



Home textiles
pg. 232

Features

Get lost in stories that give you a glimpse inside the IKEA world and what makes us tick.

Food lovers of the future	48
What makes a home a home	94
Why good design is democratic	170
Thinking inside the box	266
What home is for a refugee without one	160
Swedishness has no borders	120
Furniture made out of paper. Really?	224
When the sofa is the home	84
It's so much more than meatballs	68
Unlocking opportunities for kids through play	316
The thing about quality - an interview with Jan Ahlsén	192
The inspiring and utterly improvisational cooking style of Jonah Reider	26
Stubbornness is a virtue	240



What makes a home a home
pg. 94



The inspiring and utterly improvisational cooking style of Jonah Reider
pg. 26

Products

A small taste of the wide range that you can find at IKEA.ca and in your local store.

Growing	172
Cookware	174
Kitchen islands and trolleys	180
Kitchen accessories	182
Waste sorting	184
Tableware	186
Dining tables and chairs	196
Work desks and chairs	204
Charging	210
Lighting	212
Sofas and armchairs	218
Coffee tables	230
Home textiles	232
Decoration	244
Storage	250
Bathroom	276
Bedroom	282
Children's products	296
Food at IKEA	70
IKEA BUSINESS	202



This is IKEA®

Who we are, where we are and how you can shop with us in the way that suits you best.

Ways to shop	306
Services	309
Return policy	312
Contact information	313
IKEA FAMILY	314
People & Communities	320
Warranties	321
Working with us	325

New app, better experience

Download the IKEA Catalogue app for smart-phones or tablets on both iOS and Android, as well as Apple TV 4th Generation. You can also browse it online, at IKEA.ca/catalogue

Expectations can be wonderful. Like when you're little and on your way to your best friend's party. Or when you've just put in those last hours of work before a well-earned vacation.

Life at home is full of expectations too. But some of them are of a different kind. The kind that make things complicated and try to turn you into someone you're not.

Well, this catalogue stands on your side against all the negative expectations. We've tried to create ideas that make life easier and more enjoyable. Ideas for all parts of your home. But we've focused a little bit extra on things that happen around the kitchen. Simply because a lot of people feel pressure when it comes to food.

Most people want to have a good time and enjoy life at home, whether they're cooking or just snoozing on the sofa. If that goes for you too, you're going to have a nice read.

Goodbye expectations. Hello you.



New SALTRÖD mirror with shelf and hooks. Painted finish and mirror glass. Designer: Ebba Strandmark. RA. W50×H68cm. 802.970.02
\$64⁹⁹



New MÖLLTORP chalkboard organizer. Motif created by Archie Stone. Painted finish. W95×H67cm. 703.192.50

\$49⁹⁹

New MÅLARNA chalkboard organizer
 Painted finish. W90×H60cm. 603.111.55

\$49⁹⁹

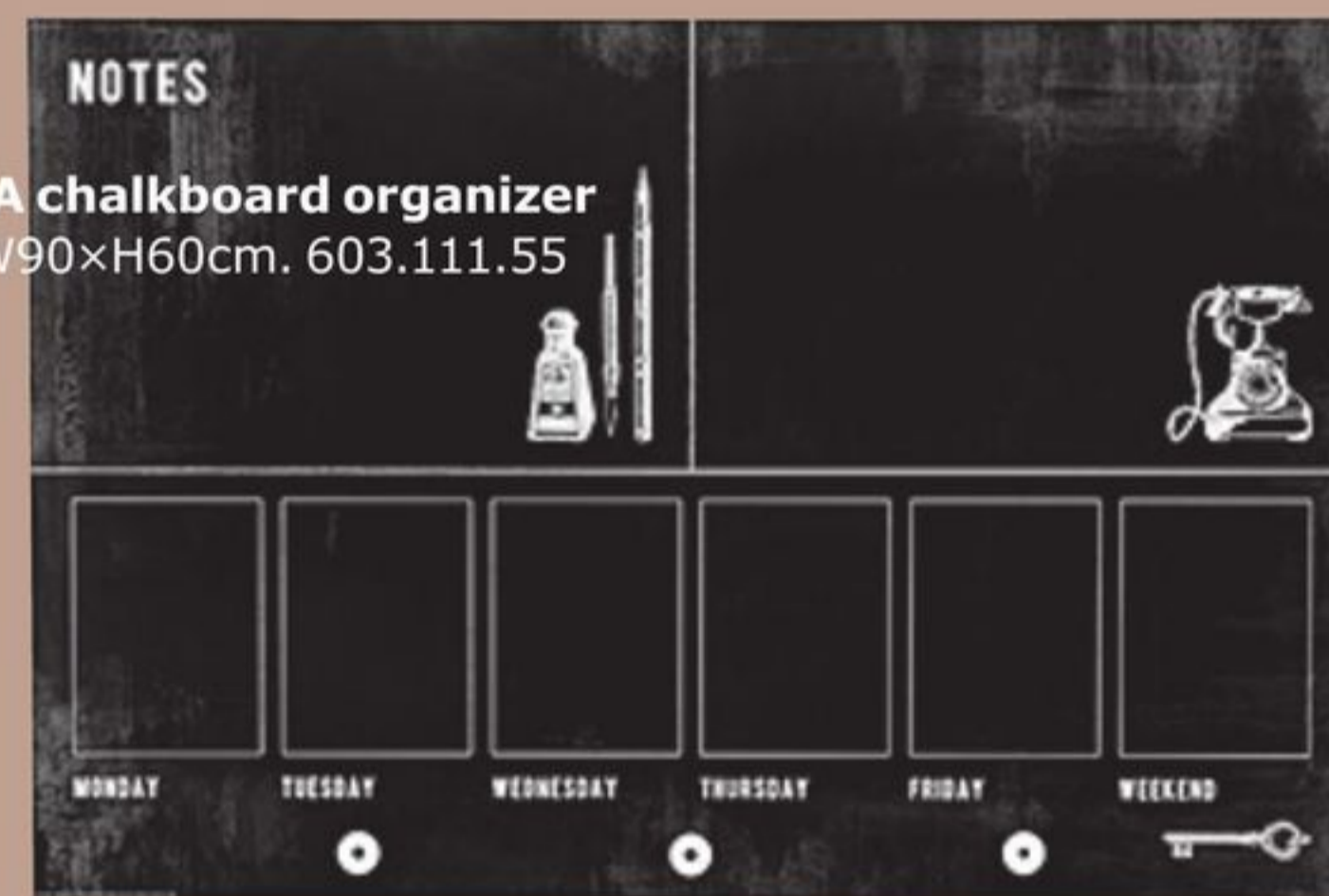

New KOPARDAL queen bed frame. Powder-coated steel. Slatted bedbase, mattress and bedlinens sold separately. RA. 691.576.68

\$199



New LIXHULT storage combination
 Powder coated steel. RA. W60×D35×H92cm. 391.616.19

\$90

RA = REQUIRES ASSEMBLY



New PENNINGGRÄS cushion \$6.99. 100% cotton. Designer: S Edholm/L Ullenius. L30×W60cm. 803.210.16

New MATTRAM cushion \$6.99. 100% cotton. Designer: Niina Aalto. L30×W60cm. 503.209.52

New HÖSTFIBBLA cushion \$6.99. 100% cotton. Designer: S Edholm/L Ullenius. L30×W60cm. 903.210.11

\$6⁹⁹/ea

News

You can see even more of our latest products throughout this catalogue, at IKEA.ca and in your local IKEA store.



New VALLENTUNA sectional, 3-seat. Fixed cover Orrsta light grey: 65% polyester, 35% cotton. Fixed cover Funnarp black/beige: 85% cotton, 15% polyester. RA. W273×D93×H104cm. Orrsta light grey/Funnarp black/beige 691.613.97

\$1015



TINGBY side table on casters. Foil and painted finish. RA. L50×W50×H45cm. 202.959.30

\$49

New KULLABERG desk.

Clear lacquered pine veneer and powder-coated steel. Designer: Ebba Strandmark. RA. W110×D70×H75cm. 691.625.99

\$189



New KULLABERG swivel chair.

Moulded eucalyptus and powder-coated steel. Designer: Sarah Fager. RA. Seat W42×D39×H44-55cm. 103.203.41

\$69⁹⁹



KALLAX shelving unit.

Foil, painted fibreboard, and particleboard. Designer: Tord Björklund. RA. W77×D39×H147cm. 503.233.85

Door inserts are sold separately.

\$99⁹⁹



New FLÄDIS basket. Seagrass. Ø37, H41cm. 003.221.71
\$19⁹⁹



New NACKSTA frame for 3 pictures. Foil finish and steel. Frame W30cm. White 103.191.73 Pictures not included.
\$14⁹⁹



New GRÖNADAL rocking chair. Clear-lacquered rattan, solid ash and steel. Designer: Lisa Hilland. RA. W57×D82×H86cm. 903.200.97
\$149

New SANNING side plate. Tempered glass. Designer: L von Schantz/I Bermúdez. Ø19cm. 603.193.83
\$250



New SANNING mug. Tempered glass. Designer: Inma Bermudez. 25cl. White 003.193.76
\$2

New SUNNERSTA mini-kitchen with sink and faucet. Stainless steel and powder-coated steel. RA. W112×D56×H139cm. 591.396.89 Appliances and containers are sold separately.

\$184



New SUNNERSTA utility cart. Powder-coated steel and polypropylene plastic. Designer: Henrik Preutz. L56×W33×H97cm. 703.037.20
\$39⁹⁹

For details, please visit IKEA.ca/news

News

You can see even more of our latest products throughout this catalogue, at IKEA.ca and in your local IKEA store.

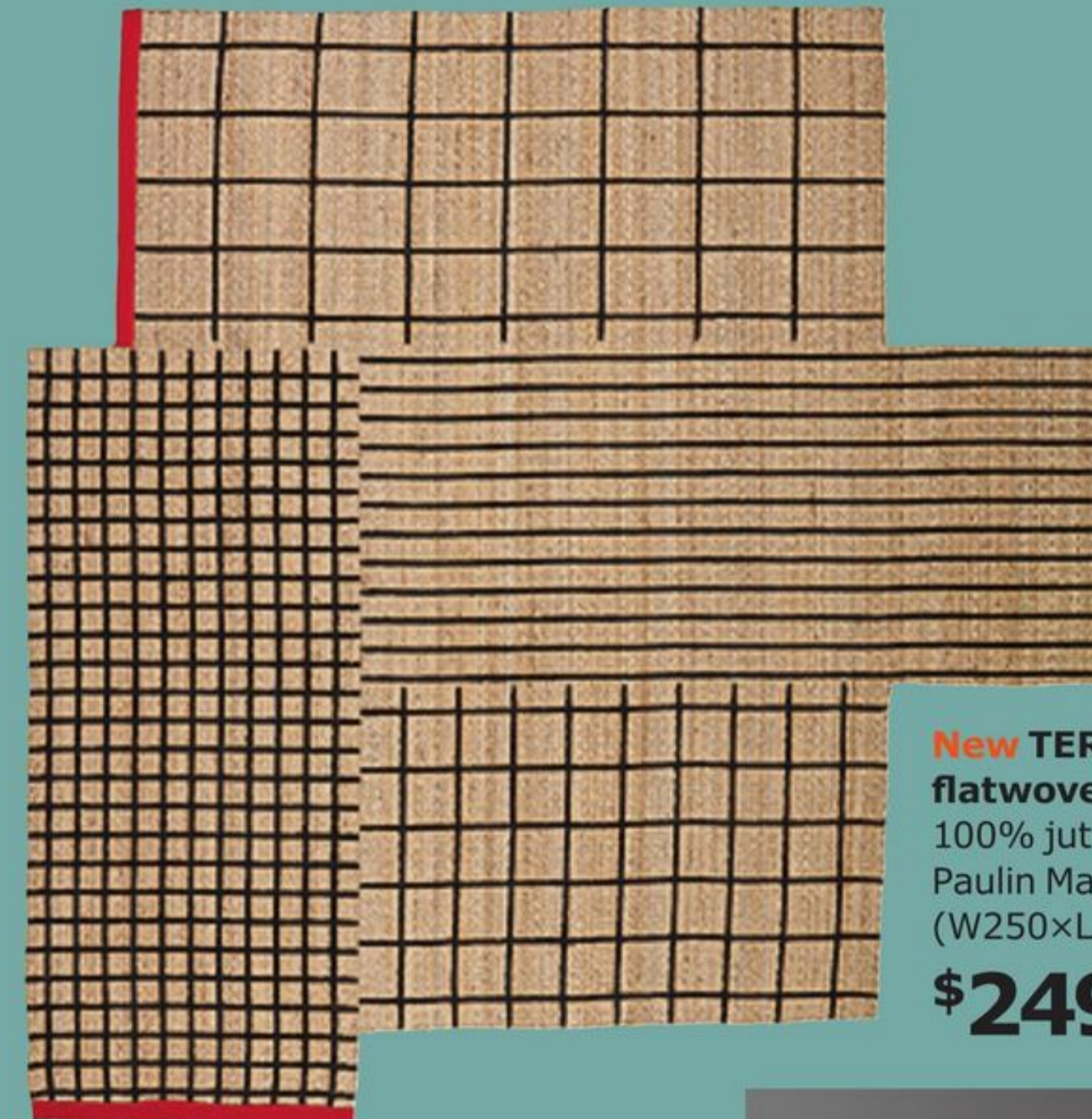

New TERNSLEV rug, flatwoven. 100% jute. Designer: Paulin Machado. 8'2"×8'2" (W250×L250cm). 402.852.56
\$249



NORRÅKER chair. Stained, clear lacquered solid birch and birch veneer. Designer: J Karlsson/N Karlsson. RA. W41×D50×H81cm. Black 003.015.26
\$99

New FLISAT doll house/wall shelf. Recommended for children 3 years and older. Tinted, clear lacquered solid pine. Designer: S Fager/J Karlsson. W58×D22×H59cm. 502.907.85 Doll furniture sold separately.
\$39⁹⁹



New KNOTTEN standing desk. Tinted, clear lacquered solid birch. Designer: K Hagberg/M Hagberg. RA. W62×D48×H105cm. 302.994.85
\$189

For details, please visit IKEA.ca/news

Dining

Meals bring us together, a time to leave the stress of the day behind and connect with what truly matters. We know that's not always the reality, but it's the one we're aiming for. To us, it doesn't matter where, how or what we eat so we're rethinking eating convention. That means creating new spaces to share a bite, elevating a meal for one, or throwing a charmingly imperfect dinner party. The dining space you create is where you celebrate, talk, catch up, make plans, and laugh at bad jokes together – and we hope it's a place you never want to leave.

01 New VARDAGEN plate \$3.50/ea.
Stoneware. Designer: Preutz/Wihlborg/
Braasch/Karlsson. Ø26cm. 802.891.82

02 New VARDAGEN glass \$5.99 /6 pack.
Was \$7.99. Tempered glass. Designer:
Preutz/Wihlborg/Braasch/Karlsson. 31cl.
002.869.17

03 New NORRARYD chair \$99/ea.
Stained, clear lacquered solid beech and
beech veneer. Designer: Nike Karlsson. RA.
W47×D51×H83cm. 402.808.43

RA=REQUIRES ASSEMBLY



01 New VARDAGEN
plate
\$3.50/ea

03 New NORRARYD
chair
\$99/ea

Imperfect is perfect enough

The “perfect” dinner party doesn’t exist. And it’s a myth that stops many of us from throwing open the doors and inviting people over. Well, it’s time to embrace our inner Italian. Friends, family and neighbours are all invited. Push together the tables, put a handful of cutlery in a jar and grab any seat you can find. This is a family-style dinner where it’s ok to spill – and put your elbows on the table.



01 MELLTORP table
\$59/ea

05 NISSE folding chair
\$19⁹⁹/ea

01 MELLTORP table \$59/ea.
Melamine foil finish and steel. RA.
L125×W75×H74cm. 190.117.77

02 OFTAST side plate 79¢/ea.
Tempered glass. Designer: Henrik Preutz.
Ø19cm. 603.189.39

03 FRODIG side plate \$3/ea.
Tempered glass. Designer: Olga Popyrina.
Ø21cm. 302.217.88

04 JANINGE chair \$69.99/ea.
Reinforced polypropylene. Designer: John/
Jonas/Petrus/Paul/Caroline. W50×D46×H76cm.
002.460.78

05 NISSE folding chair \$19.99/ea.
Powder-coated steel and polypropylene plastic.
W45×D47×H76cm. 301.150.66

RA=REQUIRES ASSEMBLY

The no-rules family dinner

These days, the family dinner is whatever – and wherever – we want it to be. But there's one thing we can all agree on – that being together is what we care about. A comfy dining spot we never want to leave is where we tell our stories, create memories and throw out the old rules. So eat at the table. Eat under the table. Eat on the sofa. Or eat in a tent. As long as it's together.

01 ARÖD floor lamp \$69.99. Adjustable head/arm. Powder-coated steel/aluminum. RA. H180cm. Grey 001.486.95

02 SÖDERHAMN chaise longue \$450/ea. Removable cover. 100% cotton. RA. W93×D151×H83cm. Finnsta turquoise 391.357.48

03 LEIFARNE chair \$55/ea. Chrome-plated steel and plastic. RA. W52×D50×H87cm. Light blue/Bröringe chrome-plated 891.278.02

04 IKEA 365+ bowl, rounded sides \$6.99/ea. Feldspar porcelain. Designer: Preutz/Wihlborg/Braasch/Karlsson. Ø22cm. 802.796.87

05 NORRÅKER table \$349. Stained, clear lacquered solid birch. Designer: J Karlsson/N Karlsson. RA. L220×W80×H74cm. 802.908.16

06 URBAN junior chair \$49.99. Recommended for children aged 3 years and older. Polypropylene plastic. Designer: Carl Öjerstam. W45×D48×H79cm. 001.652.13

RA=REQUIRES ASSEMBLY



02 SÖDERHAMN
chaise longue

\$450/ea

05 NORRÅKER
table

\$349

06

Table for one, please

It's strange that eating alone gets a bad rap, because it's something many of us really enjoy. You can share a meal with quiet and entertaining dining companions – like a magazine, your computer or a favourite TV show. But it doesn't mean dining at a small table. A big one allows you to really spread out on the nights you're alone – and accommodate your more chatty companions when dear friends come over.



03 SKYN serving bowl
\$16⁹⁹

01 IKEA 365+ wine glass \$2.99. Tempered glass. Designer: Preutz/Wihlborg/Braasch/Karlsson. 30cl. 702.783.63

02 INGATORP extendable table \$399. Stained, clear lacquered beech veneer. Designer: Carina Bengs. RA. L155/215xW87xH74cm. 902.224.07

03 SKYN serving bowl \$16.99. Bone china. Designer: Ehlén Johansson. Ø16cm. 901.767.97

04 RÅSKOG stool \$29.99. Powder-coated steel. Designer: Nike Karlsson. RA. W44xD44xH45cm. 803.083.93

05 INGOLF chair \$59.99/ea. Stained, clear lacquered solid pine. Designer: Carina Bengs. RA. W43xD52xH91cm. 602.178.22

RA=REQUIRES ASSEMBLY



A table that expands with extra panels can host a big group – when you want to.

04

05 INGOLF chair
\$59⁹⁹/ea

02 INGATORP extendable table
\$399

01

Delivery service. We can bring your purchases to your home or business. Prices from \$79. See page 309.

The passion project table

The dining table has long been used for a lot more than just eating. So we're breaking with tradition and renaming this one the "project table" – a hub of the home where everyone gathers to play and work (a little). Here are all of the books, supplies and good lighting needed to plan a faraway trip, do some homework or make something beautiful. It's a convenient, cozy spot to get creative.

01 SVIRVEL pendant lamp \$24.99/ea.
Polypropylene plastic and steel. Designer: C Martin/M Elebäck. RA. Ø22cm. 802.808.22

02 BERNHARD chair \$189/ea.
Chrome-plated steel and leather. Designer: Ola Wihlborg. RA. W49×D50×H77cm. Chrome-plated/Mjuk green 203.347.38

03 IKEA 365+ deep plate/bowl \$3.50/ea.
Feldspar porcelain. Designer: Preutz/Wihlborg/Braasch/Karlsson. Ø17cm. 502.797.02

04 VÄSTANÄ/VÄSTANBY table \$309/ea.
Stained, clear-lacquered solid beech and ash veneer. RA. L170×W78×H75cm. 590.403.44

05 KVISSLE cable management box \$16.99/ea.
Powder-coated steel and cork. Designer: Eva Lilja Löwenhielm. W33×D12×H12cm. 301.980.28

RA=REQUIRES ASSEMBLY



03 IKEA 365+ deep plate/bowl \$3.50/ea.



04 VÄSTANÄ/VÄSTANBY table \$309/ea.

A tray can hold all of the little things, making it easy to clear off the table in seconds.



01 **New SEKTION/KALVIA** storage combination
\$1305

02

03

NEW LOWER PRICE

04 **ÖVRARYD/BACKARYD** table
Was \$169

\$159

The dream dining area

The dining area is where we gather – to share a meal, tell stories and make grand plans. And it’s important to get it just the way you want it because the atmosphere helps create these moments – big and small. The table and chairs are based on the style you like and the size you need. Bringing the rest together requires just a few key pieces that create the right mood for merry-making.

01 SEKTION wall cabinets with New KALVIA doors \$1305. This combination consists of: SEKTION wall cabinets in melamine foil. KALVIA doors in foil finish and FÖRBÄTTRA cover panels. UTRUSTA shelves in melamine foil. LIMHAMN legs in stainless steel and UTRUSTA push openers. RA. W72xD15¼xH75”.

02 SINNERLIG pendant lamp \$89.99. Clear lacquered bamboo. Designer: Ilse Crawford. RA. Ø50, H54cm. 703.150.30

03 VILMAR chair \$59.99/ea. Stained, clear lacquered oak veneer/chrome-plated steel. Designer: Johanna Jelinek. RA. W52xD55xH89cm. 798.897.50

04 New ÖVRARYD/BACKARYD table \$159. Was \$169. Powder coated steel, particleboard and bamboo. L150xW78xH75cm. 791.407.00

05 LOHALS rug, flatwoven \$149. 100% jute. 6’ 6”x 9’ 9” (W200xL300cm). 002.773.95

RA=REQUIRES ASSEMBLY



Decoration

One piece of décor that’s characterful and eye-catching can quickly elevate the dining area. It could be as big as a sideboard or as small as a centerpiece on the table, as long as it expresses a bit of your personality too.

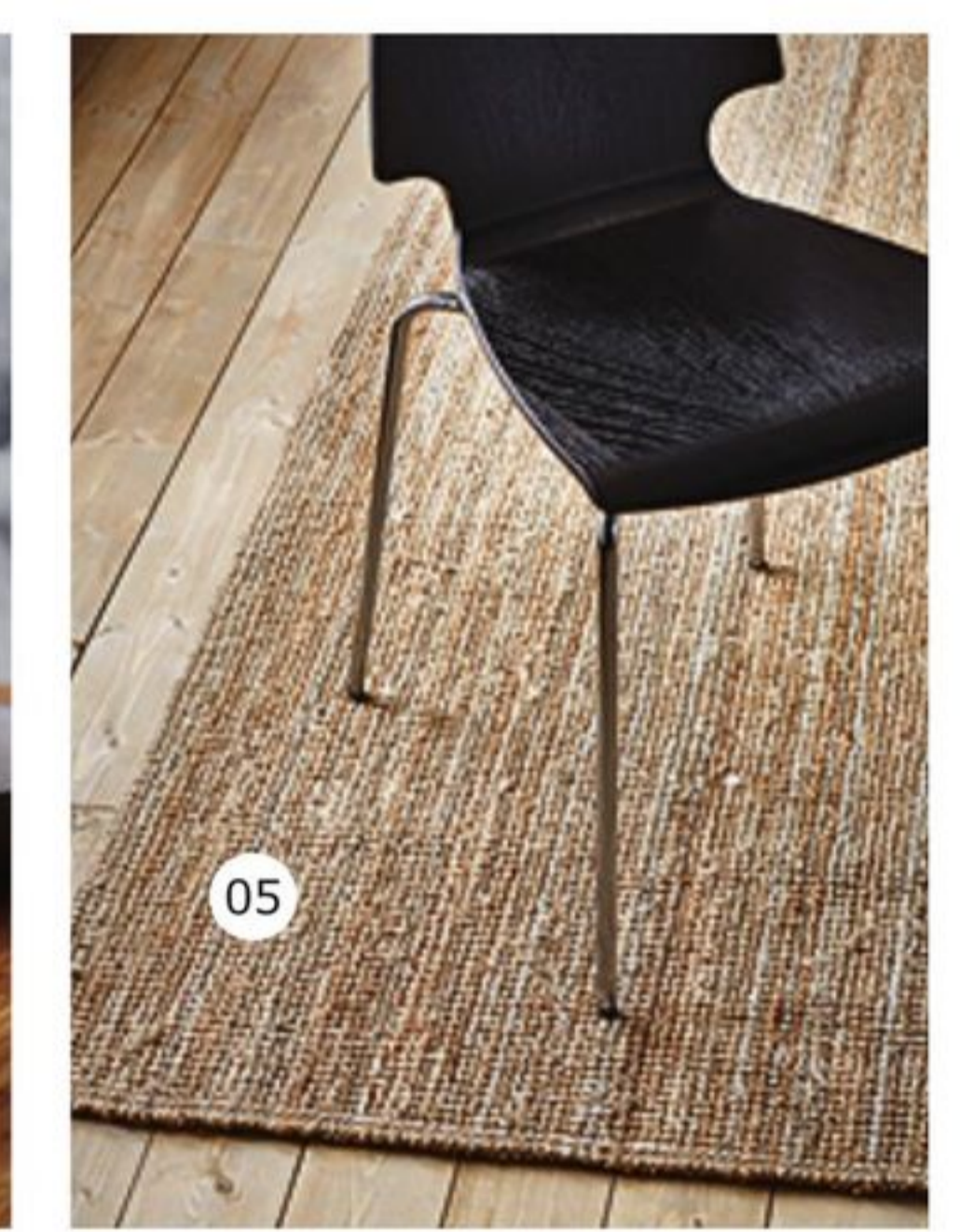

Rug

Dining areas can be stain magnets, but rugs in sisal and wool are best equipped to resist mealtime spills. The size can be bigger than your table so when you pull out the chairs, the rug is still underneath the legs.



Lighting

The best light for the dining area feels like candlelight, helping to create that warm atmosphere. Ceiling lighting that is proportionate to your dining table is key. And so are dimmable bulbs that help to set the mood.

Date-worthy dining for two

When the kids have grown up and moved out, it's a chance to reconnect – and reinvent how you spend time together. Now every meal is just for two, a mini date where you can sit close and get cozy. You can share a home-cooked meal at the table, coffee in comfy armchairs or breakfast on the floor. It's up to you. With the room to create these spaces now, everyday dining becomes a bit more intimate.



01 **KLIPSK**
bed tray
\$12⁹⁹



03

01 KLIPSK bed tray \$12.99.

Reinforced polypropylene. Designer: Marcus Arvonen. L56xW36cm. 002.588.82

02 IVRIG glass \$1.99/ea.

Glass. Designer: Ola Wihlborg. 30cl. 902.583.21

03 IKEA 365+ mug \$3.50/ea.

Feldspar porcelain. Designer: Preutz/Wihlborg/Braasch/Karlsson. 36cl. 802.783.67

04 STOCKHOLM pendant light \$149.

Powder-coated steel. RA. Ø55cm. White 902.161.33

05 TUNHOLMEN table, outdoor \$109.

Powder-coated aluminum. Designer: David Wahl. RA. L58xW69xH71cm. 602.594.97

06 JANINGE chair \$79.99.

Reinforced polypropylene. Designer: John/Jonas/Petrus/Paul/Caroline. W50xD46xH76cm. 602.460.80

RA=REQUIRES ASSEMBLY

Delivery service. We can bring your purchases to your home or business. Prices from \$79. See page 309.



04

06 **JANINGE**
chair
\$79⁹⁹

05 **TUNHOLMEN**
table, outdoor

\$109

Share a meal – anywhere

Our meals have migrated – from the dining table to the sofa, floor and desk. These days, a meal with friends or family doesn't have to happen around a perfectly set table. And it doesn't even have to include chairs. The days of "have to" are over. Go ahead and eat around a coffee table. Sit on the sofa. Or the floor. Because it doesn't really matter where we eat – just that we get to be together.



01 IKEA PS LÖVÅS
sofa bed

\$439

02 FOTO
pendant lamp
\$24.99



03 OFTAST
bowl
79¢



04



05

06

01 IKEA PS LÖVÅS sofa bed **\$439**. Cover: 100% cotton. RA. W163xD111xH86cm. Bed size 160x205cm. Vansta dark blue 798.743.91

02 FOTO pendant lamp **\$24.99**. Lacquered aluminum. Designer: Nicolas Cortolezzis. Plug-in function. Ø38cm. 901.281.84

03 OFTAST bowl **79¢**. Tempered glass. Designer: Henrik Preutz. Ø15cm. 802.589.15

04 POKAL glass **99¢/ea.** Tempered glass. 35cl. 102.704.78

05 LINNMON table top **\$33.99**. Printed and embossed finish. L150xW75cm. 102.513.52

06 KNAGGLIG box **\$14.99/ea.** Untreated solid pine. W46xD31xH25cm. 702.923.59

RA=REQUIRES ASSEMBLY

Left | Slicing up oven-roasted beets to serve with some simply prepared pan-seared scallops.

The inspiring and utterly improvisational cooking style of Jonah Reider

This year's catalogue encourages us all to let go of big expectations in the kitchen. It's about throwing out the rules and recipes, embracing our imperfections, and getting rid of that voice in our head that tells us we "should" be doing things a certain way. Jonah Reider just happens to be that kind of cook, a kindred spirit who believes, like we do, in bringing fun, ease and confidence back into the kitchen.

▼ Dive deeper into our features by downloading the IKEA Catalogue app.

Jonah Reider has been feted as the "dorm-room chef." Known for the inventive and intimate supper club meals that he served out of his Columbia University dorm, the wait list attracted thousands. But it's his relaxed and refreshing approach to cooking that attracts us – and sparks something in us that makes us want to head for the kitchen to just create, no matter what ends up on the plate.

Quite simply, Jonah is our culinary spirit animal, a guy who cooks with perceptible skill yet still embraces those little mistakes and imperfections we all make in the

kitchen. The 21-year-old's style is spontaneous, letting the people he's with, the ingredients he's found, or even the way he's feeling in that moment inspire his creations.

"Most people cook spontaneously, yet they constantly compare their cooking with that of a very formal, fine restaurant," Jonah says. "Thankfully you can make excellent food in this spontaneous, messy, social way."

The dinners he hosted at his dorm-room supper club – up until his graduation in May 2016 – were very much built on this philosophy. >>

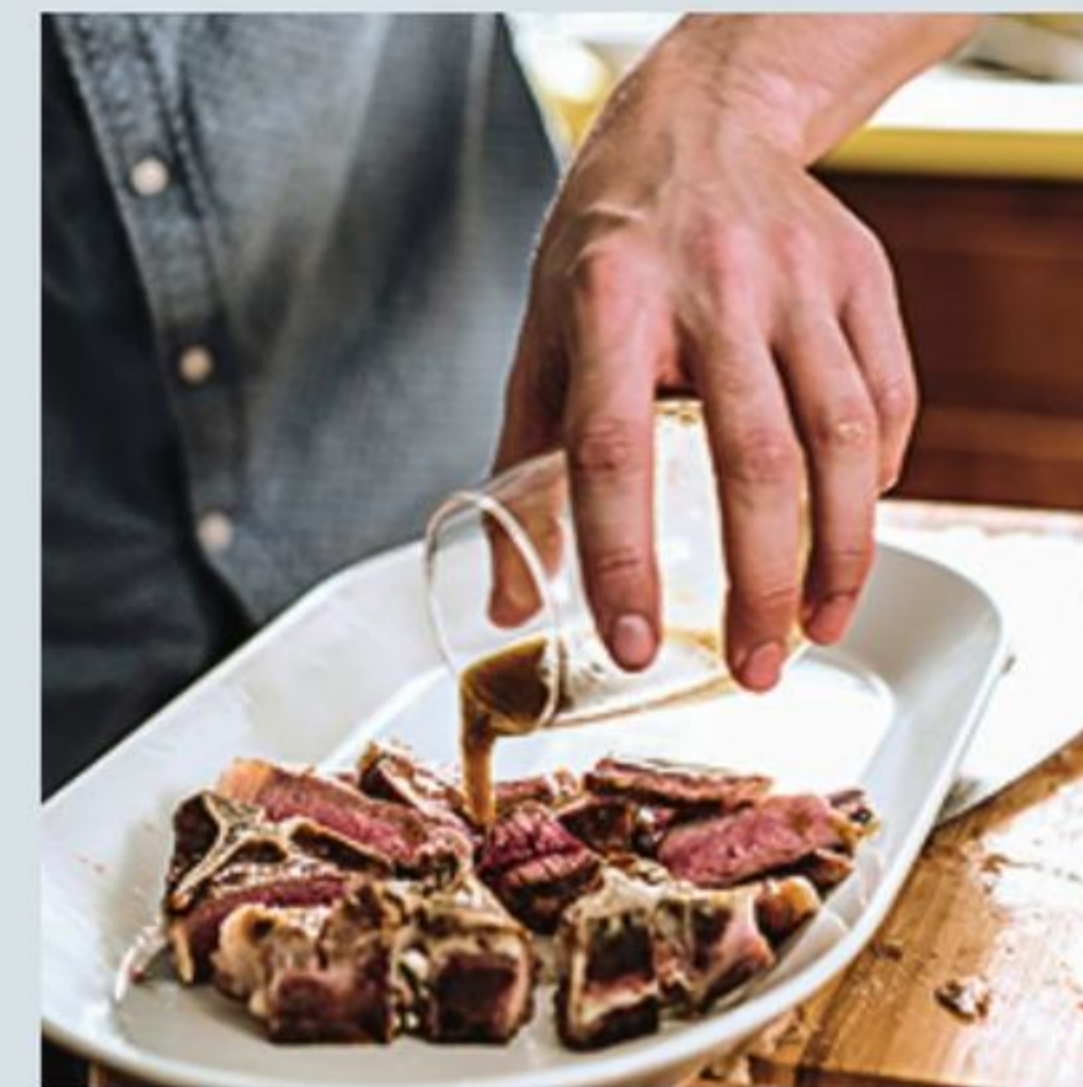
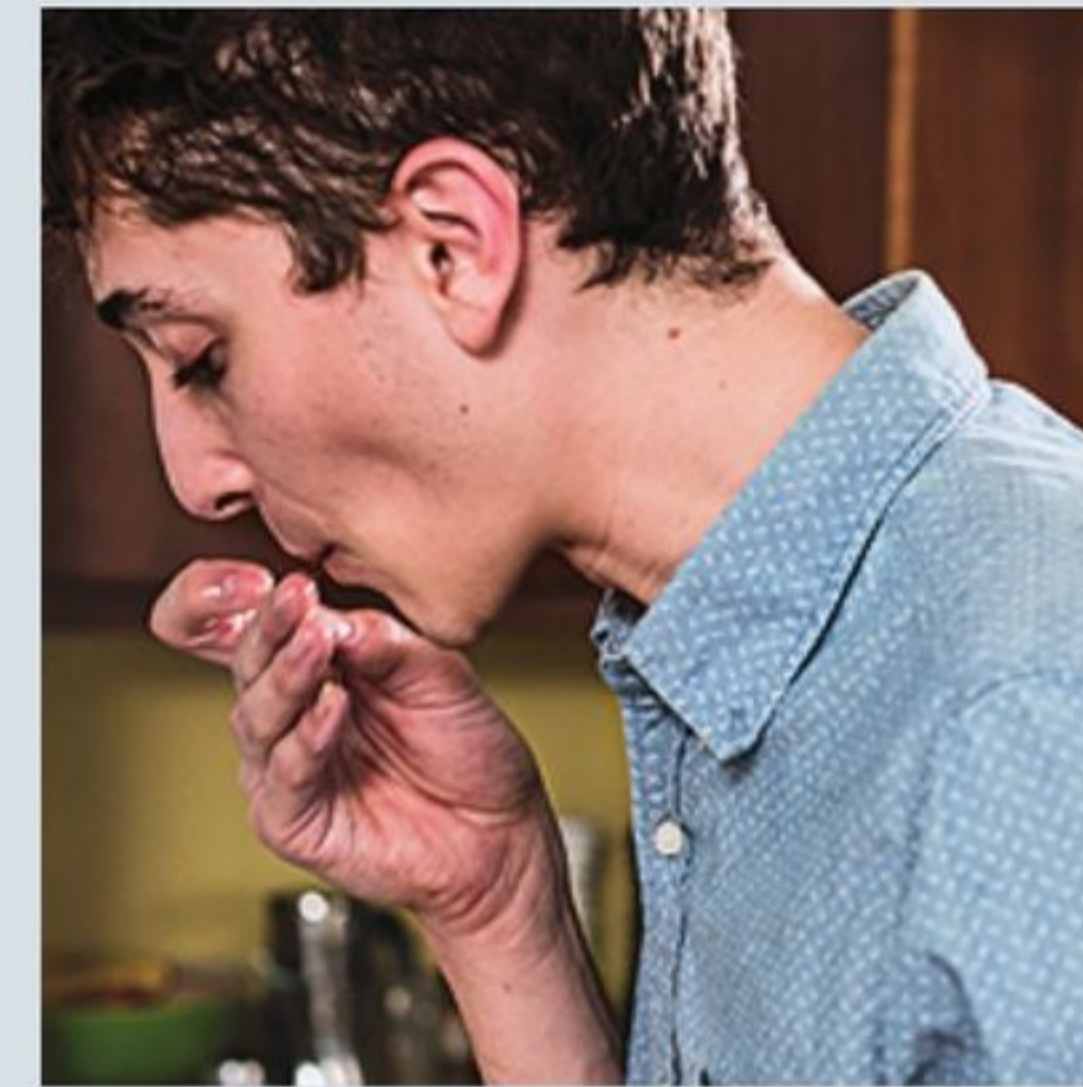

“I’m always improvising, like if I run out of a spice, or two more people are coming all of a sudden. I’m open to the possibility of things not going how you expect them to.”

It began when he got off the university meal plan and started cooking at home, asking friends to share meals with him. Then word on campus spread, and soon thousands waited patiently to try his low cost, family style meals.

The food Jonah creates is adventurous, confident and charmingly imperfect. You can taste his personality on the plate and the whirling, kinetic energy he pours into each dish. In fact, he never uses recipes, preferring instead to experiment and improvise even if it doesn’t work out quite the way he planned – an approach taken in part from his training as a jazz pianist.

“In jazz, everyone is making mistakes all the time, and you just have to embrace the unexpected,” Jonah says. “I’m always improvising if I run out of a spice or if two more people are coming all of a sudden. Being open to the possibility of things not going how you expect them to is integral to the process of cooking.”

In his mind, it’s those unexpected moments that allow great food – and a great time together – to really happen. He tells the story of a meal where he served guests a beautiful roasted duckling, but then realized – he had no idea how to actually carve a duck. Didn’t matter. He and his guests had a great time hacking away at the duck and figuring it out.

“If something goes wrong in the kitchen, you can let that fluster you and have it derail what you’re making or you can just kind of embrace it and see what happens,” Jonah says. “When the reason people are having a meal together is to connect, then mistakes become fun and nourishing.”

The intimacy he creates between friends and strangers alike is the part of the meal

that interests Jonah the most. What leads to great cooking, in his mind, is having a spirit and energy that invites other people in and curates a great atmosphere.

“I think of what I’m doing as creating a social experience mediated by food, instead of being a chef,” Jonah says. “When people come over to eat with me, the point is to not go to a restaurant. It’s to share an experience with people. That experience for the diners is the only important thing.”

Placing the importance on the social part of dining is also his secret for letting go of those big expectations we tend to put on ourselves, with the prevalence of food television programs and social media images.

“Seeing photographs of beautiful, intricate dishes can make people feel shut out of the kitchen,” Jonah says. “But it’s just not true that that is the only manifestation of excellent cooking. A large part of good cooking is a good social environment and an excitement about creating food. That is what is most exciting to me – and to a lot of others, once they realize this.”

After graduation, he plans to expand his dinner beyond the dorm room to bring his quirky and intimate meals to larger audiences at events around the country.

“People are very excited when they see how low key and extremely fun dining can be,” Jonah says. “They realize, wow this is something I can do myself – have friends over and cook incredible food, and turn it into an awesome hangout.” ■



Above | Serving two homemade sorbets with candied parsnip on top.



“If something goes wrong in the kitchen, you can let that fluster you and have it derail what you’re making, or you can just kind of embrace it and see what happens.”



Left | Prepping the main dishes – lamb with mushrooms, chopped hazelnuts and sage along with razor clams garnished with garlic, shallots and beets.

Cooking that thinks ahead



With no less than three layers of steel at the bottom, the VARDAGEN pot not only boosts your cooking by providing an even and energy-efficient heat. It also gives you a head start on the washing up by preventing food from burning or sticking.

VARDAGEN pot with lid \$29.99.
Was \$34.99: Stainless steel with aluminum core.
Designer: Preutz/Wihlborg/Braasch/Karlsson.
5L. 803.057.14 [Shop online at IKEA.ca](#)

A natural fit for nature's finest



The RISATORP basket is a practical companion for going grocery shopping, for fetching homegrown veggies from the garden. Or perhaps just as a decorative display to hold your finds as you get home.

RISATORP basket \$12.99/ea.
Powder-coated steel and clear lacquered solid birch. Designer: Wiebke Braasch.
L25xW26xH18cm.
Green 502.816.20 White 902.816.18
[Shop online at IKEA.ca](#)

Kitchen

There is so much cooking inspiration out there these days, and while it encourages us to get into the kitchen it also sets the bar a bit too high. Filtered photos of perfectly plated meals are not the reality – but a home-cooked meal shared with our favourite people can be. So we're offering some ideas that could help take the pressure off. Like making it easier to prepare and cook meals in a small space; refreshing a rental kitchen to make it work for you; or simply creating a space that inspires you to cook like no one's watching.

01 SENIOR
casserole with lid
\$54.99

01 SENIOR casserole with lid \$54.99. Enamelled cast iron. Designer: Kristian Krogh. 3L. 902.328.40

02 RÖRT fork \$1.99. Oiled solid beech. Designer: Johanna Jelinek. L32cm. 002.784.65

03 SENIOR frying pan \$39.99. Enamelled cast iron. Designer: Kristian Krogh. Ø28cm. 902.648.45



Cook like no one's watching

The appeal of cooking for one is all about perception. You could see it as an inspiration-less chore, something you simply have to do. Or you could see the possibilities – because when you're one, you can literally do whatever you want. Stay in your pyjamas. Sing a cheesy rock anthem in your loudest voice. And cook with gusto, even if things end up on the floor. It's about customizing a kitchen just for you, one that inspires you to cook like no one's watching.

01 VISPAD mixing bowl, set of 2 \$9.99.
 Sizes: 2.3 L (Ø22cm) and 3.7 L (Ø26cm). Plastic.
 902.575.19

02 SEKTION kitchen with BOBBYN off-white doors, drawer fronts, glass doors and MAXIMERA soft-closing drawers. This combination \$9575.

Starting from \$125/linear foot.* Was \$129/linear foot. SEKTION cabinet frames in white melamine foil. BOBBYN doors/drawer fronts in painted finish and glass doors in tempered glass. MAXIMERA drawers in powder coated steel and melamine foil. Styled with HISHULT handles/knobs in white feldspar porcelain. RA.

03 PERSONLIG quartz countertop. This combination \$3753. Easy to maintain, non-porous material. Shown here in Jet Black.

* Linear foot price based on a standard 10×10' kitchen. See page 324 for what's included in the price.

RA=REQUIRES ASSEMBLY



01 VISPAD
 mixing bowl,
 set of 2.
\$9.99



02 SEKTION/BOBBYN
 kitchen
 This combination
\$9575

What's in the price?
 See page 324

For appliances add
\$7344

For countertop add
\$3753

In home kitchen planning
\$250/up to 4 hours.
 See page 309

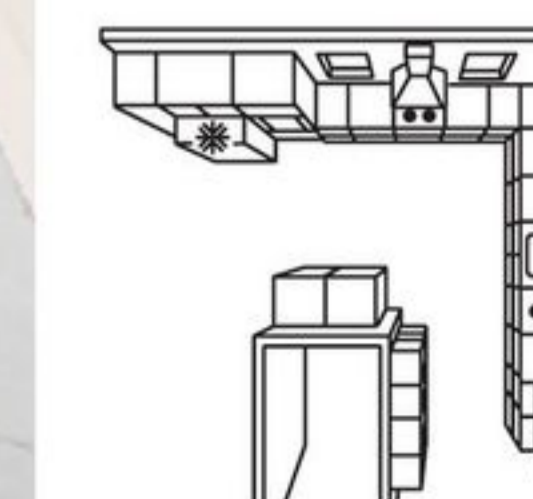

Stress-free socializing

Imagine this dinner party: you standing in the kitchen with friends, chatting and laughing all night long. No running around in your sauce-stained apron, and no panic when the doorbell rings. It's the no-expectations dinner party, where it's ok to put your guests to work. Everyone cooks together in an atmosphere that's casual and cosy – a pressure-less affair that allows you to be a guest too.

01 SEKTION kitchen with VOXTORP light beige high-gloss doors, drawer fronts and MAXIMERA soft-closing drawers. This combination \$5299.

Starting from \$145/linear foot.* SEKTION cabinet frames in white melamine foil. VOXTORP doors/drawer fronts in high-gloss foil finish. MAXIMERA drawers in powder coated steel and melamine foil. RA.

02 PERSONLIG acrylic countertop. This combination \$2856. Easy to maintain, non-porous material. Shown here in Neo White.

03 OBEROENDE extractor hood \$1299. 400CFM. Stainless steel 603.391.35

* Linear foot price based on a standard 10x10' kitchen. See page 324 for what's included in the price.

RA=REQUIRES ASSEMBLY



01 SEKTION/VOXTORP
kitchen
This combination
\$5299

What's in the price?
See page 324

For appliances add
\$7745

For countertop add
\$2856

In home kitchen planning
\$250/up to 4 hours
See page 309

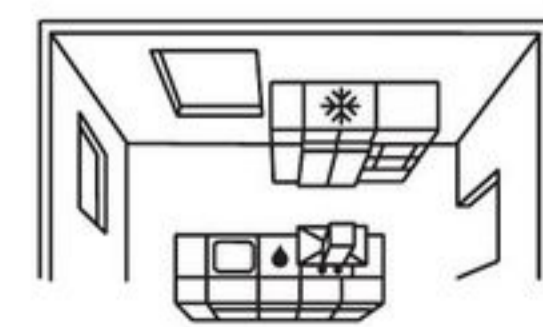

03 OBEROENDE
Extractor hood
\$1299

A kitchen that moves with you

This is actually a kitchen – with all of the basic tools you need. There’s space for a cooktop for cooking, a mini-fridge for cooling, and a sink for doing the dishes you’d like to forget. There’s no major planning or blueprints. No intricate installation. Just a simple kitchen you can add wherever you need one. So when you’re proudly bearing the badges of youth – a thin wallet and a small space – you can have a functional kitchen that feels like home. And when home moves somewhere else, you can just take it with you.

01 LEJEN cabinet \$12.99/ea. ABS plastic. Designer: David Wahl. W20×D23×H31cm. 502.794.67

02 OUMBÄRLIG 7-piece cookware set \$69.99 Was \$79.99. Includes: Pot with lid 5L, pot with lid 3L, saucepan with lid 2L and frying pan Ø28cm. Stainless steel. Frying pan: Teflon® Platinum+ coating. 302.864.16

03 GRUNDTAL wall shelf \$34.99/ea. Stainless steel. Designer: Mikael Warnhammar. RA. L120×D27×H20cm. 700.227.63

04 SUNNERSTA mini-kitchen with SUNNERSTA trolley and LAGAN kitchen faucet \$224. This combination consists of: SUNNERSTA mini-kitchen in stainless steel and powder coated steel. SUNNERSTA trolley in powder coated steel. LAGAN kitchen faucet in chrome-plated brass. LILLVIKEN strainer. RA. W44½×D22×H54¾". SUNNERSTA kitchen is designed for small compact appliances. A mini fridge and portable induction cooktop is perfect when you have little space. We are currently developing these appliances and they will be in stores Spring 2017.

RA=REQUIRES ASSEMBLY



Hanna
Deputy range manager, Sweden

We talk to lots of people around the world to better understand their real needs at home. Many who lead a young, urban lifestyle told us they want a simple kitchen that's easy to buy, to take home, to install and even – if you're a bit nomadic – to move to your next home. As well as compact and practical, we think that the result looks great, too.

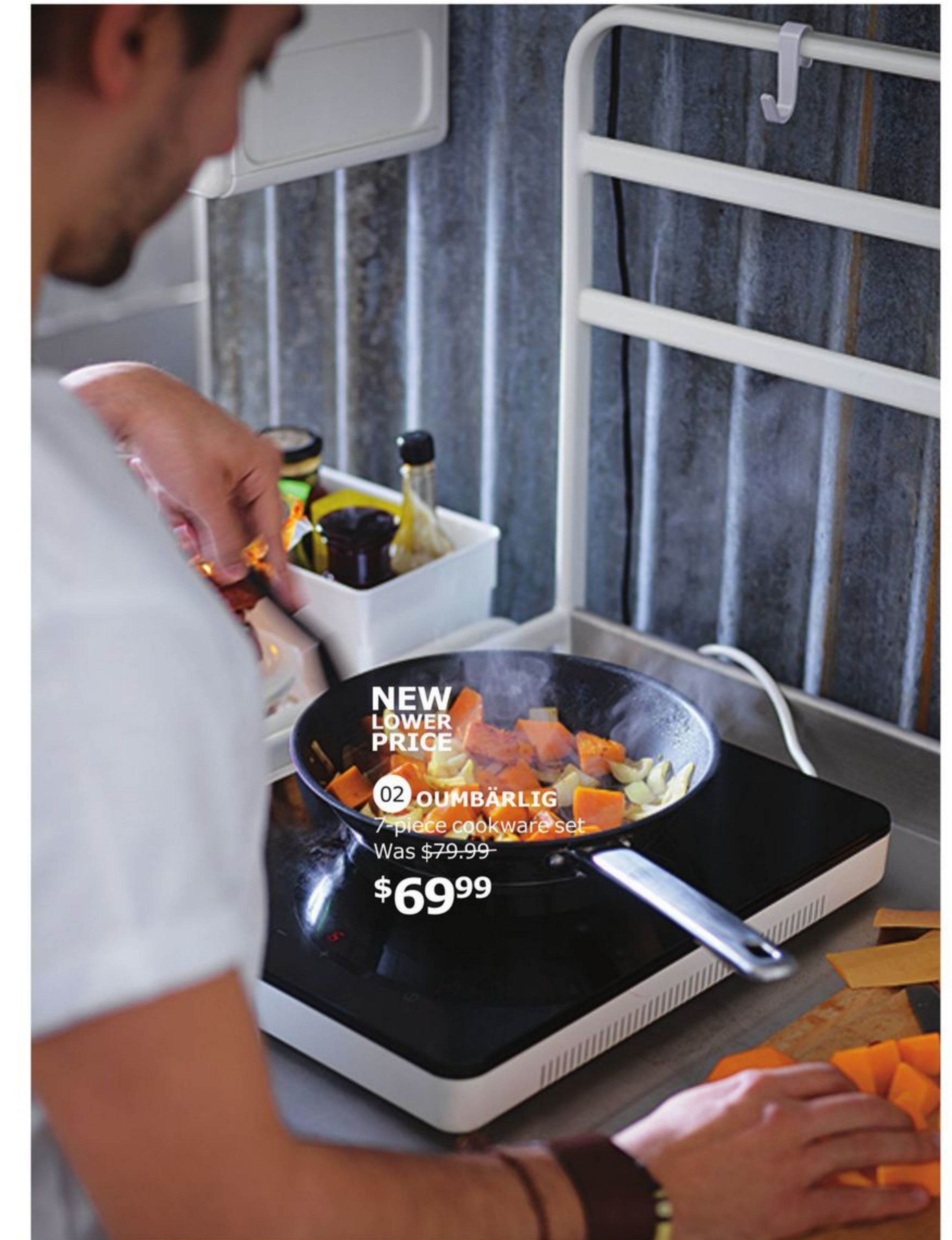

01 LEJEN cabinet \$12.99/ea

02 OUMBÄRLIG 7-piece cookware set \$69.99

03 GRUNDTAL wall shelf \$34.99/ea

04 SUNNERSTA/ LAGAN/LILLVIKEN kitchen \$224

In home kitchen planning \$250/up to 4 hours

Mise en place

Counter space in the kitchen is a bit like time, travel or love – we always want more of it. But exploring our culinary talents in a small space is made easier with tips from the pros. Chefs organize and arrange their ingredients before cooking to save room and time – a practice the French call "mise en place". Taking just 10 minutes to chop all of your ingredients and then laying out the tools you need makes the cooking part way more fun.

01 JÄMKA food container with lid, set of 4 \$3.99. Sizes: 0.3L (20×14×4cm), 0.5L (20×14×6cm) 2 of each. Plastic. Designer: Ola Wihlborg. 701.873.63

02 New VARDAGEN bowl \$2.99/ea. Glass. Designer: Preutz/Wihlborg/Braasch/Karlsson. Ø15cm. 602.892.63

03 VARDAGEN bowl \$2. Stoneware. Designer: Preutz/Wihlborg/Braasch/Karlsson. Ø12cm. 102.892.27

04 APTITLIG chopping board \$9.99. Bamboo. Designer: Jon Karlsson. L45×W28cm. 802.334.30

05 IKEA 365+ utility knife \$14.99. Stainless molybdenum/vanadium-steel. Designer: Preutz/Wihlborg/Braasch/Karlsson. Length of knife blade: 14 cm. 102.835.17



A stage for the chefs

This is a kitchen for the chefs – the ones who fantasize about finely tuned utensils, endless counter space and gadgets that can cook any meal. The pro tools here might surprise, like a steam oven that makes food more flavourful, a gas stove for fast and controlled frying, and rows of neatly organized utensils for every purpose. It's a place to geek out and unleash your inner chef.



01 VARIERA knife tray \$17.99. Bamboo, Clear polyurethane lacquer. W5 $\frac{7}{8}$ ×D19 $\frac{3}{4}$ ×H2 $\frac{1}{8}$ ". 402.635.65

02 VIMMERN kitchen faucet with handspray \$229. Zirconium coated brass. RA. H18 $\frac{1}{2}$ ". 103.052.89

03 SEKTION kitchen with MÄRSTA white doors, drawer fronts and MAXIMERA soft-closing drawers. This combination \$4719. Starting at \$145/linear foot.* SEKTION cabinet frames in white melamine foil. MÄRSTA doors/drawer fronts in foil finish. The included foil stickers for handles come in the colours oak, brown, white and pink. MAXIMERA drawers in powder coated steel and melamine foil. RA.

04 BARKABODA walnut countertop \$265. Solid walnut, foil, and particleboard, cut to size. L74×D25 $\frac{5}{8}$ ×H1 $\frac{1}{2}$ ". 103.314.72

05 PERSONLIG quartz countertop. This combination \$3588. Easy to maintain, non-porous material. Shown here in Pure White.

* Linear foot price based on a standard 10×10' kitchen. See page 324 for what's included in the price.

RA=REQUIRES ASSEMBLY



02 VIMMERN
kitchen faucet/
handspray
\$229



03 SEKTION/MÄRSTA
kitchen
This combination
\$4719

What's in the price?
See page 324

For appliances add
\$7994

For countertop add
\$3588

In home kitchen planning
\$250/up to 4 hours
See page 309

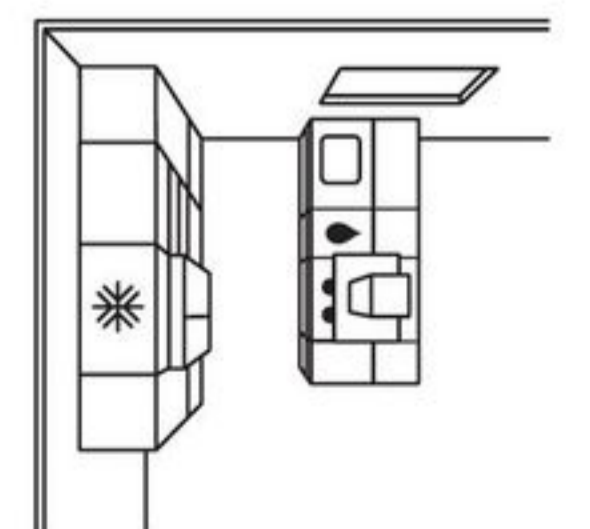

A balcony fit for a feast

When the air is warm, all we want to do is move outdoors. And it doesn't require as much room as you might think. Even a small balcony can be turned into a space-efficient spot to prepare and serve a tasty meal. Shelves pull double duty, housing the freshest ingredients for a balcony feast, as well as creating a prep area for chopping and chatting. It's an inviting space that makes summer meals feel like a mini-vacation.

01 HINDÖ shelving unit, indoor/outdoor \$69.99. Powder-coated steel and galvanized steel. Designer: David Wahl. RA. W78xD37xH82cm. 502.902.81

02 HINDÖ shelving unit w/cabinet, in/outdoor \$169. Powder-coated steel and galvanized steel. RA. W78xD37xH158cm. 490.484.54

03 TUNHOLMEN table+2 chairs, outdoor \$269. Powder-coated aluminum. Designer: David Wahl. RA. Table L58xW69xH71cm. Chair W55xD55xH78cm. 390.484.21

04 New VARDAGEN bowl \$7.99. Glass. Designer: Preutz/Wihlborg/Braasch/Karlsson. Ø26cm. 702.892.48

05 VARDAGEN carafe with lid \$3.99/ea. Glass and silicon rubber. Designer: Preutz/Wihlborg/Braasch/Karlsson. 1.0L. 502.919.21

06 IKEA 365+ chef's knife \$19.99. Stainless molybdenum/vanadium-steel. Designer: Preutz/Wihlborg/Braasch/Karlsson. Length of knife blade: 20cm. 102.835.22

RA=REQUIRES ASSEMBLY



02 HINDÖ cabinet w shelving unit in/outdoor \$169

01

03

04 New VARDAGEN bowl \$7.99

05

06

01

Cooking is the best part of the meal

In this family kitchen, there are never too many cooks. All of the counter space can be found on the big island, a place to stand elbow-to-elbow while each peels, chops and dices up their part of the meal. And having two sinks helps relieve the usual traffic jams that can happen in a crowded kitchen. It ensures that everyone can be involved in a family ritual that brings us closer – and creates some messy memories.

01 NUTID counter depth refrigerator \$2499.

Built in water and ice maker. LED lighting illuminates every corner. 21 cubic feet. Stainless steel 002.887.56

02 FJÄLKINGE shelving unit \$130/ea.

Powder-coated steel. Designer: Ehlén Johansson. RA. W118×D35×H193cm. 602.216.83

03 SEKTION kitchen with EKESTAD brown oak veneer doors, drawer fronts and MAXIMERA soft-closing drawers. This combination \$5635.

Starting at \$135/linear foot.* SEKTION cabinet frames in brown wood effect melamine foil. EKESTAD doors/drawer fronts in stained, clear lacquered oak veneer/solid ash. MAXIMERA drawers in powder coated steel and melamine foil. Styled with ORRNÄS knobs/handles in stainless steel. RA.

04 PERSONLIG quartz countertop.

This combination \$3588. Easy to maintain, non-porous material. Shown here in Pure White.

* Linear foot price based on a standard 10×10' kitchen. See page 324 for what's included in the price.

RA=REQUIRES ASSEMBLY



03 SEKTION/EKESTAD kitchen

This combination

\$5635

What's in the price?
See page 324

For appliances add
\$7794

For countertop add
\$3588

In home kitchen planning
\$250/up to 4 hours
See page 309

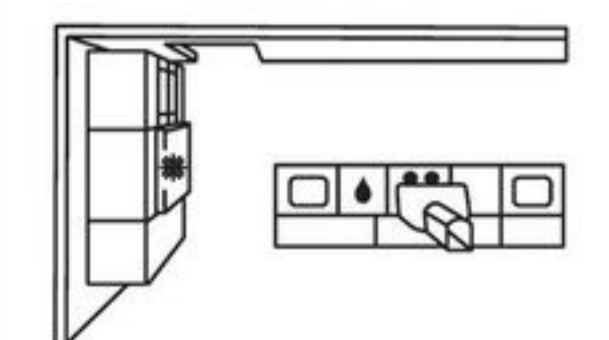

Food lovers of the future

Cooking is a beloved ritual, a rite of passage, and a lifelong skill. It is something many of us teach our children when they get a bit older. But getting kids in the kitchen at a younger age can have benefits you never imagined, from liking a bigger variety of foods (think: veggies) to learning how to eat healthy and improving social relationships. The impact is astounding – and surprisingly simple to make.



Above | The protective sleeve – as well as the child-friendly design – make SMÅBIT safer than an adult knife.

Cooking a meal is about much more than nourishment. It is a gesture of generosity and even love that can be felt and tasted. Introducing kids to favourite family dishes or recipes that have been passed down allows us to share and preserve our cultures – and create some of our strongest memories. But when it comes to the prospect of our little ones interacting with hot pans, knives and boiling water, most parents get more than a little nervous.

“Parents are scared of kids using things like the oven, stovetops and the kettle,” says Bryan Urbick, CEO and President of the Consumer Knowledge Centre, and an author and lecturer on the subjects of children and food. “Kids need to have tools so they can participate themselves and not

have parents fearful about their safety. The more tools we have like that, the better.”

Well, IKEA felt the same. Seeing the potential for a lost generation of cooks because of the abundance of processed and fast foods, an IKEA product developer and a technician decided to create a kid-friendly knife. It’s sharp yet safer than an adult knife – and it’s called SMÅBIT.

“If you want your kids to start cooking at an early age, you have nothing for them to use,” says IKEA product developer Lennie Malmgren, a trained chef who has worked in the cooking department for six years. “Everything is oversized. So you give them a butter knife, which is not sharp at all. Then the kids get tired, bored and they don’t want to cook any more.” >>

“We are losing a full generation of people who can cook,” Lennie says. “That is what we wanted to change. We wanted to get children around eight years old interested in cooking.”

Despite being every bit as sharp as an adult version, the SMÅBIT knife has been made safer for tiny hands. It has a non-slip grip, a protective plastic sleeve and a blunt tip. The SMÅBIT collection also includes a peeler with a safer T-shape that allows kids to peel potatoes, carrots and more.

“It’s like having training wheels,” Lennie says. “A knife and peeler are great because it starts by letting kids touch food, cut it, scrape it, peel it and make a mess. It offers positive exposure to food. And parents don’t have to be afraid.”

This very physical and interactive experience

with food is more important than most of us realize. Involving children in the cooking process helps make new foods more familiar and less scary. And, it gives kids the one thing that leads to more positive experiences with new food: control.

And control could just be the secret to the Mount Everest of parenting goals: getting kids to like vegetables.

“The knife gives them control over the vegetable,” Bryan says. “It’s all about giving people control and reducing their fear. The more kids control the food preparation, the more they are likely to enjoy the food and ultimately eat better.”

Giving children control over some of the ingredients in the family meal leads to benefits that grow over time. The more kids experience a wide variety of foods without



“The more kids control the food preparation, the more they are likely to enjoy the food and ultimately eat better.”

Bryan Urbick, CEO and President of the Consumer Knowledge Centre



fear, the more varied their diets will be when they’re adults. And variety is something that helps kids’ nutrition for the rest of their lives.

“By not engaging kids in the kitchen, you may be setting their eating habits for life” Bryan says. “It sets children up to be more likely to buy prepared foods and eat out more often. You might also create picky eaters as adults, and picky eaters aren’t very fun to eat with. Food is such an integral part of our lives for physical and social reasons.”

Bryan says he understands the fears parents have, but that with the right support and tools, kids can begin to learn how to prepare food as early as the age of three – when they’ve absorbed much of the world and start to understand concepts.

“If you learn to cook at an early age, you will continue with it,” Lennie says. “It’s like riding a bike or learning a language; if you learn it at an older age it takes so much longer and you might lose interest. And the core of cooking – and the kitchen – is the knife. If you have one and know how to use it, you can basically do anything.” ■

5 rules for parents when cooking with kids (from the kids)

- 1 |** Don’t correct us all the time. That just makes us want to run out and never come back.
- 2 |** Don’t get mad if we fail. A smart guy once said “we learn from our mistakes.” We believe that guy.
- 3 |** Don’t rush us! Learning takes time; try to relax for a minute.
- 4 |** It’s ok to get tired or lose interest.
- 5 |** And what’s wrong with being messy?! It’s actually more fun that way. You’ll see.



SMÅBIT knife and peeler \$7.99. Child-friendly and recommended for ages from 8 years. Includes: Knife 9cm (total length 18cm) and peeler 11cm. Stainless steel and plastic. Designer: Tina Christensen. 402.864.06



Lennie Malmgren, IKEA product developer.

Tidy sink, happy cook

The sink is the messy heart of the kitchen. Most of your prep and cooking happens right around it, making it a magnet for pots, peelings and more. It's a spot that needs some organization to give everything a place of its own. Containers and inserts divide it up so you can use the sink right up until mealtime. And if you just can't handle the dishes right now, it's ok. That cutting board can cover it up. Nothing to see here.



01 New GRUNDVATTNET mat \$4.99.
Recycled PP plastic. Designer: Brickstad/
Palleschitz/Petersén. L12 $\frac{3}{8}$ "x10 $\frac{1}{4}$ "xH3 $\frac{3}{8}$ ".
103.142.84

02 New GRUNDVATTNET colander \$4.99.
Polypropylene plastic and synthetic rubber.
Designer: Brickstad/Palleschitz/Petersén.
L18xW6xH4". 903.142.80

03 ANTAGEN dish-washing brush 99¢. Plastic.
Designer: Lycke von Schantz. L25cm. 202.339.61

04 New GRUNDVATTNET chopping board \$12.99. Polyethylene plastic. Designer:
Brickstad/Palleschitz/Petersén. L17 $\frac{3}{4}$ "xW15"xH $\frac{1}{2}$ ".
503.142.82

05 New GRUNDVATTNET box \$5.99.
Polypropylene plastic and synthetic rubber.
Designer: Brickstad/Palleschitz/Petersén.
L7xW5xH3". 103.142.98



04 New GRUNDVATTNET
chopping board

\$12.99

Set your kitchen free

It often feels as if there are lots of rules and expectations in the kitchen. And it kills the inspiration because you end up designing it to look the way you're told it should – and not like you. Well it's time to liberate your kitchen, and create the space that inspires you. For us, it's a cool and playful cube that divides one room up into four. It is our blank canvas, a place to experiment and be adventurous. Whatever it might be for you, we say go for it. Because if it's your happy place, that's all that matters.

▼ Fully experience the cube with our virtual reality feature in the catalogue app.

01 SEKTION kitchen with TINGSRYD black wood effect doors, drawer fronts, MAXIMERA soft-closing drawers and GREVSTA plinth. This combination \$3138.

Starting at \$69/linear foot.*

SEKTION cabinet frames in brown wood effect melamine foil. TINGSRYD doors/drawer fronts in melamine foil. MAXIMERA drawers in powder coated steel and melamine foil. GREVSTA plinth in stainless steel colour foil finish. Styled with BLANKETT handles in anodized aluminum. RA.

02 PERSONLIG quartz countertop.

This combination \$2196. Easy to maintain, non-porous surface. Shown here in Jet Black.

03 BETRODD double oven range \$1549.

Cook two dishes at the same time or just use the upper oven for day to day cooking. Energy savings when only heating the small oven cavity. W29 $\frac{7}{8}$ ×D28 $\frac{1}{2}$ ×H47 $\frac{1}{8}$ ". Stainless steel 802.885.59

* Linear foot price based on a standard 10×10' kitchen. See page 324 for what's included in the price.

RA=REQUIRES ASSEMBLY



An organized office can be built using cabinets from the kitchen.

01 SEKTION/TINGSRYD kitchen
This combination

\$3138

What's in the price?
See page 324

For appliances add \$4096

For countertop add \$2196

In home kitchen planning \$250/up to 4 hours
See page 309

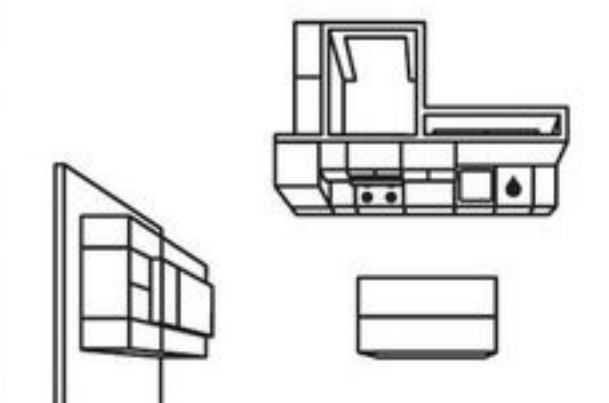

The Swedish kitchen

There is no place that captures the true character and customs of our homeland better than a Swedish kitchen. Many of the things we value most – being close to nature, eating long meals together, and allowing our kids all over the home – guide how Swedes design their kitchens. These inviting and approachable spaces reflect the simplicity of the landscape around us – in materials, in style and in personality. This is how we live, and we're proud to share it (but not too proud – that's not Swedish).

01 SEKTION kitchen with TORHAMN ash veneer doors, drawer fronts, glass-doors and MAXIMERA soft-closing drawers. This combination \$6599.

Starting at \$149/linear foot.*
SEKTION cabinet frames in white melamine foil. TORHAMN doors/drawer fronts in clear lacquered ash veneer/solid ash and glass doors in tempered glass. MAXIMERA drawers in powder coated steel and melamine foil. Styled with BORGHAMN black handles in powder coated steel. RA.

02 PERSONLIG quartz countertop. This combination \$2474. Easy to maintain, non-porous surface. Shown here in Nougat.

03 ELVERDAM kitchen faucet \$129. Zirconium coated brass. Designer: Nike Karlsson. RA. H15¾". 402.115.76

04 FALSTERBO wall shelf \$99/ea. Powder-coated steel. Designer: Mikael Axelsson. RA. W60xD32xH100cm. 003.158.87

05 LUFTIG extractor hood \$499. Wall mounted hood with 4 different speeds. 400 CFM. W30xD20xH38⅝-52". Stainless steel 403.391.36

* Linear foot price based on a standard 10x10' kitchen. See page 324 for what's included in the price.

RA=REQUIRES ASSEMBLY



01 SEKTION/TORHAMN kitchen

\$6599

What's in the price?
See page 324

For appliances add \$5196

For countertop add \$2474

In home kitchen planning \$250/up to 4 hours
See page 309

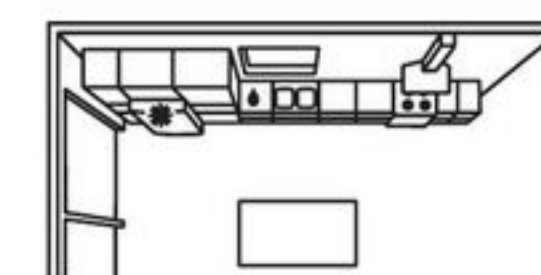

Using natural materials like this ash wood veneer brings the best of the outdoors inside.

Eating what we buy

That pang of guilt we get when throwing away food that's past its prime is all too real. But if you can't see it, you can't eat it. Reimagining the kitchen so it's designed to reflect how we actually eat can help us waste a lot less food. Simple things – like storing food in transparent containers or putting it on open shelves rather than in deep cupboards – inspires us to cook with what we have, rather than buying more.



Blending up older produce is a nutritious and tasty way to minimize food waste.



01 BEHÅLLARE water bottle
\$3.99/ea. Plastic. 0.6L. 802.846.60

02 TILLSLUTA dry food jars with lid. Plastic. **Dry food jar with lid \$15.99/ea.** L31×W23×H23cm. 10L. 202.574.95 **Dry food jar with lid \$12.99/ea.** L31×W23×H12cm. 5.5L. 202.336.83 **Dry food jar with lid \$7.99/ea.** L23×W15×H12cm. 2.5L. 402.574.99 **Dry food jar with lid \$6.99/ea.** L15×W11×H12cm. 1L. 502.336.86

03 SEKTION kitchen with RINGHULT white high-gloss drawer fronts, doors and MAXIMERA soft-closing drawers. This combination \$2600.

Starting at \$129/linear foot.*
Was \$135/linear foot.

SEKTION cabinet frames in white melamine foil. RINGHULT drawer fronts/doors in high-gloss foil finish. MAXIMERA drawers in powder coated steel and melamine foil. Styled with BLANKETT handles in anodized aluminum. RA.

04 SÄLJAN laminate countertop. This combination \$150.

Black mineral effect, cut to size.
1 of ea: 602.749.83/102.749.85

* Linear foot price based on a standard 10×10' kitchen. See page 324 for what's included in the price.

RA=REQUIRES ASSEMBLY



03 SEKTION/RINGHULT
kitchen
This combination
\$2600

What's in the price?
See page 324

For appliances add
\$4895

For countertop add
\$150

In home kitchen planning
\$250/up to 4 hours
See page 309

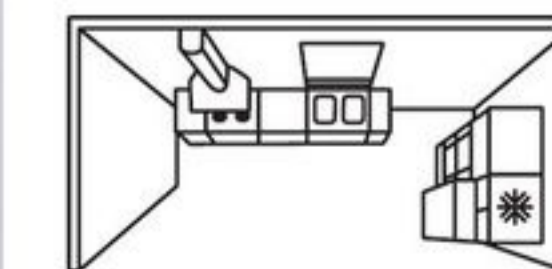



01 DIMPA recycling bag
\$2.99/ea

Small acts, big change

Most of us are aware of the impact our daily lives can have on the planet, but “being sustainable” can feel like a big job. The thing we often forget, though, is that we’re not supposed to do it alone. The key is finding small ways to do our part. Because when we add up these small acts, that’s when the big change really happens.



Water-saving faucets are an easy way to automatically use up to 40% less water. Changing out regular bulbs for LED versions is also an effortless way to make an impact – and lower your electric bill. And when it comes to recycling, just a few bins will take care of your metal, plastic and food waste.



01 DIMPA recycling bag
\$2.99/ea. Label holder is included. Polypropylene plastic. W22xD35xH45cm. 35L. 302.916.39

02 RINGSKÄR single lever kitchen faucet \$99. Nickel-plated brass. Designer: Mikael Warnhammar. RA. H15". 201.315.52

03 VARIERA series. Recycled PP plastic. Designer: D Wahl/L von Schantz. RA. Recycling bin, 11L \$8.99/ea. L9¼xW8¼xH12¾". 402.461.04 Recycling bin, 22L \$13.99/ea. L15⅝xW9¼xH12¾". 302.046.23 Lid for recycling bin, 11L \$3/ea. L8⅞xW7⅝". 302.046.18 Lid for recycling bin, 22L \$3/ea. L14¼xW8⅞". 902.460.93

RA=REQUIRES ASSEMBLY



03 VARIERA recycling bin, 22L, with lid \$16.99/ea

Refreshing the rental

Kitchens in rental homes don't always have the functionality needed by passionate home cooks. But you don't have to start from scratch to get it. You can recreate a bit of that restaurant kitchen feeling at home with a smart, add-on workstation for things like filleting and julienning. A wheeled trolley can bring your favourite tools closer. And don't worry if the result on the plate is not quite what you imagined. The mistakes are what make it better next time.

01 GRUNDTAL kitchen cart \$169/ea. Stainless steel. Designer: Mikael Warnhammar. RA. L54xW41xH90cm. 702.173.36

02 ALGOT wall shelving unit \$202. Adjustable shelves. Powder-coated steel and plastic. RA. W172xD40xH196cm. 090.025.61

03 GRUNDTAL magnetic knife rack \$14.99. Stainless steel and plastic. RA. L40cm. 602.386.45

04 GRUNDTAL rail \$8.99. Stainless steel. Designer: Mikael Warnhammar. RA. L80cm. 202.135.38

05 RIMFORSA work bench \$699. Stainless steel and bamboo. Designer: Ehlén Johansson. RA. L47¼xW24¾xH36¼". 203.250.17

RA=REQUIRES ASSEMBLY



Playing with personality

A new kitchen doesn't always require an investment with your wallet. Sometimes it's an investment of your time and creativity. And with a bit of both, you can have a lot of fun creating the low-price kitchen of your dreams. Construct a makeshift kitchen island, cover a wall with cabinets or paint raw wood surfaces any colour you like. With a little bit of love, the result is as personal as it gets – a kitchen that looks and feels just like you.

01 SEKTION kitchen with HITTARP off-white doors, drawer fronts and MAXIMERA soft-closing drawers. This combination \$2512.

Starting at \$125/linear foot.*
SEKTION cabinet frames in white melamine foil. HITTARP doors/drawer fronts in painted finish. MAXIMERA drawers in powder coated steel and melamine foil. Styled with MÖLLARP knobs in clear lacquered zinc. RA.

02 EKBACKEN countertop \$120.

Double-sided, light grey/white laminate countertop with white edge, cut to size. L74xD25½xH1½". 002.913.39

03 IVAR cabinet \$99/ea. Solid pine. Shown here painted light blue, pink and light green. RA. W80xD30xH83cm. 400.337.63

04 AINA curtains, 1 pair \$69.99. 100% linen. W145xL250cm/per panel. White 102.842.01

05 NUTID built in oven \$1099. Large oven capacity 5.0 cubic feet. W30xD26¾xH28¾". Stainless steel 702.885.88

06 BEKVÄM kitchen cart \$69.99. Solid birch. RA. L22¾xW19¾xH33½". 302.403.48

GRUNDTAL rail \$4.99. Stainless steel. 15¾". 002.135.39 (shown on BEKVÄM kitchen cart)

* Linear foot price based on a standard 10x10' kitchen. See page 324 for what's included in the price.

RA=REQUIRES ASSEMBLY



01 SEKTION/HITTARP
kitchen
This combination

\$2512

What's in the price?
See page 324

For appliances add
\$5245

For countertop add
\$120

In home kitchen planning
\$250/up to 4 hours
See page 309

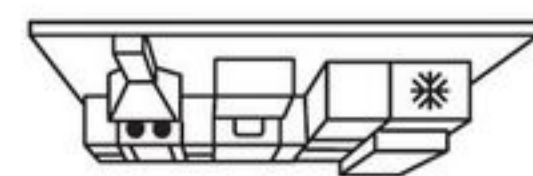

06 BEKVÄM
kitchen cart
\$69.99

A better way to store food

A pantry is like having a mini grocery store at home. With a total overview, it's easier to eat more of what you have. But creating one doesn't require a big space. Simply add a curtain to a corner to keep it dark and cool. Inside, food is displayed in glass jars to inspire your next meal, while metal drawers take root vegetables out of the fridge for good. The pantry is an add-on that keeps food fresher longer – and ups your kitchen confidence.

01 IVAR shelving unit with drawers \$347. Adjustable shelves. Solid pine. RA. W134×D30×H226cm. 191.813.69

02 IVAR drawer \$20/ea. Powder coated steel and polyester. Designer: Sarah Fager. RA. W39×D30×H14cm. 703.047.72

03 KORKEN jar with lid \$2.99/ea. Glass. Ø12, H16.5cm. 1L. 902.279.85

04 IVAR label holder \$2.49/2 pack. Powder coated steel and polyester. Designer: Sarah Fager. W6×D3×H2cm. 903.047.71

05 IVAR hook for shelf \$2.49/2 pack. Powder coated steel and polyester. Designer: Sarah Fager. W2×D3×H7cm. 303.047.74

RA=REQUIRES ASSEMBLY

01 IVAR shelving unit with drawers \$347



Metal drawers

Metal drawers are the ideal spot to store root vegetables, mimicking the dark and cool conditions they're used to when growing underground. It means your veggies stay fresher for longer.



Glass jars

Using glass jars to preserve tasty foods is sustainable and energy saving. It also keeps your conscience clear because it helps you save food that might otherwise be thrown out.



Shelf labels

Keeping your pantry organized is as simple as adding metal label holders to the front of your shelves. It helps you identify the food you've preserved in jars, and makes it easier to find what you're looking for.

Everywhere we look, food seems to be at the very top of the agenda – or should we say menu. What, how and where we eat is constantly the centre of attention. Food is now about well-being and health, as well as a personal expression. The world has become food obsessed. We're hungry – not only for the food itself, but also for the facts and figures that come with each serving.

It's so much more than meatballs

More and more people are actually reading the info and nutritional charts on packages. It wasn't always like this, but one thing's for sure: our relationship with food has changed, and all of us who produce, cook and serve food – and love and care about how we do so – need to take notice.

At IKEA we ask ourselves: have we kept up with this development? Has the food we serve and the experience we offer changed at the same pace as people's passion, interest and awareness in food? The long and the short of it is: no. We didn't pay enough attention to what people were thinking about the experience. We simply had to start changing.

Today, people's interest in food is considerably higher than ever before – partly because there is such a variety of food. The ingredients and flavours available today certainly inspire more kitchen creativity than we could have dreamed of a few decades back. Many ingredients and dishes that we take for granted today were nowhere to be found in the food landscape of the 1970s and 80s. In Sweden, there was a huge focus on "meat and potatoes" and a global focus on processed food – it was easy and convenient. Few questioned the quality or nutritional value of its content. And with

the arrival of the microwave, these ready-made meals became even more popular.

Even though our first restaurant opened in 1959, at our first store in Älmhult, Sweden, it was in this era that the IKEA restaurants came of age. For example, our beloved – and today, iconic – meatballs were launched globally in 1985. And for a long time, the IKEA restaurants stayed in that decade. But now we are moving to offer our customers a stronger feeling of modern Sweden and improving the eating experience in our stores.

Today, the food you're served and the experience you get from a visit to one of our restaurants has a different taste than in previous decades.

Of course, much remains to be done, but we're getting there – one dish at a time. And it's you, all of our customers and restaurant guests, that help us keep our commitment to being responsible, modern, and forward thinking. Over a year's time, we have roughly 640 million visitors that eat, drink or shop, either in our restaurants, bistros or in the IKEA Swedish Food Market.

The good thing about serving so many people the way we do at IKEA is that if something is not right, or not up to customer satisfaction, someone will speak up and make their voice heard. In the past, our



Above | Michael La Cour, Managing Director IKEA Food, and Product Developer David Johansson trying out new flavours in the test kitchen.



Above | The pulled salmon recipe coming together ingredient by ingredient.



Pulled Salmon Sandwich

4–6 sandwiches

Ingredients:

400 gr hot smoked salmon
(LAX VARMRÖKT 400gr, IKEA product)
½ tbsp BBQ sauce
2 tbsp chopped chives
burger buns
pickled red cabbage

For serving:

pickled cucumber
(GURKA INLAGD, IKEA product)
leafy greens

How to make:

Pulled salmon: Peel off the skin on the hot smoked salmon and pull the salmon meat into smaller pieces into a bowl. Add the BBQ sauce and the chopped chives and mix it gently with your clean hands.

Assemble the sandwich: Cut buns with a sharp knife and open it up. Put a little of the greens on the bottom part of the bread, then the pulled salmon, red cabbage and pickled cucumber. Put the bread top on and serve. Enjoy!

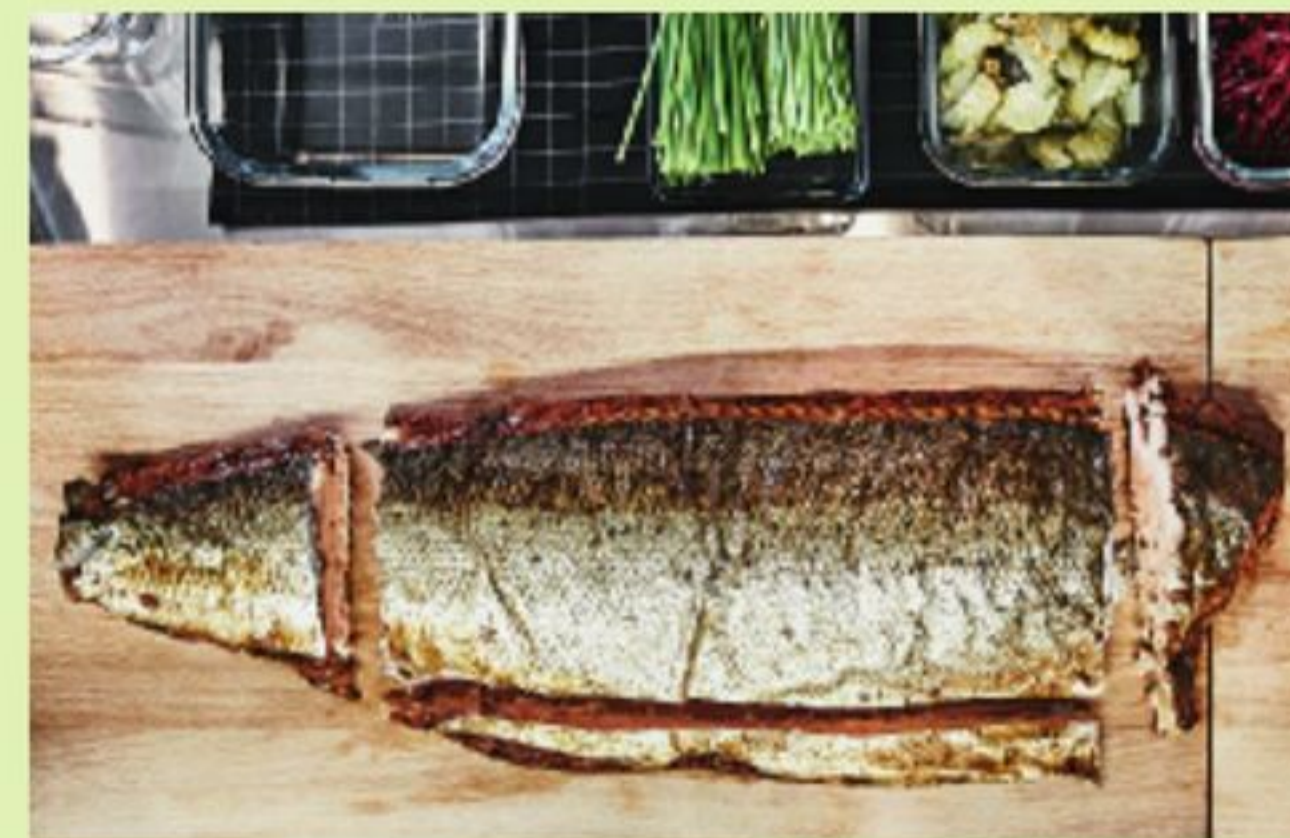

Below | Pulling from both ends. Pulled salmon is created by maximum use and minimum waste. Deliciously sustainable.

guests have spoken up, and they continue to do so. This is something that we're grateful for – it helps us cook and serve better food. We're not a fancy restaurant with a genius chef who's always right. We're actually the complete opposite of that. Welcoming people into our kitchen and listening to their opinions is the best way that our 16,500 IKEA Food co-workers can ensure a food range that's appealing, delicious, and that people want to enjoy.

It's also making us even more inspired and passionate about food. As we head into the future of food, our commitment means that we really need to know what health and wellness means in terms of our food offering. This is fantastic, but also a great responsibility. We need to be able to tell people where their food comes from, how it's sourced, and what impact it has on the planet.

Every third calorie that is produced in the world goes to waste – a huge amount. 29% of Europe's CO2 footprint comes from the food industry alone. So while we will always serve our beloved meatballs, we now also offer delicious veggie balls, which have a smaller carbon footprint by 30 times. "Swedishness" is an essential part of who are, and to us, this means simple, nourishing food that is seasonally relevant and sustainable.

We are also proud to have the largest offerings of ASC or MSC certified seafood in the world. You can trust that it comes from sustainable and responsible sources.

But through all of these changes, there's one thing that will stay the same at IKEA – and that's the affordable prices for you and your family. So thank YOU for giving us the best cooking lessons. We're looking forward to many more, and to providing you with many more food products with a modern taste of Sweden – honest food for people and the planet. ■

Responsibly sourced

We are committed to only sell and serve seafood from MSC-certified fisheries and ASC-certified farms. For IKEA, responsible seafood sourcing is a natural contribution to our vision of creating a better everyday life for the many.



Eating at IKEA®

Welcome to your IKEA Restaurant – where you can turn up when you like and stay for as long as you want. You can tuck into a tasty breakfast, lunch or dinner – or just grab a quick coffee. The wide menu of Swedish-style dishes and local specials includes plenty of healthy options as well as indulgent treats, so the whole family can enjoy its favourites. And, with prices that are just as tempting, you can satisfy your appetite with little impact on your wallet. Like to try some Swedish specials at home? You can pick up many of the ingredients in the Swedish Food Market before you leave the store.

\$6⁹⁹

Swedish Meatballs or Chicken Meatballs with mashed potatoes, vegetables, lingonberry jam and cream sauce.
Probably the most famous of all IKEA products – the traditional Swedish dish that's now enjoyed everywhere.



All our salmon meets the ASC's (Aquaculture Stewardship Council) global standard for responsibly farmed seafood.

\$8⁹⁹

Salmon fillet with wheat pilaf and hollandaise sauce.*

Healthier meals to tickle your tastebuds

You can always enjoy a healthy, well-balanced meal with great flavours. And you can trust that the ingredients meet high standards of environmental and social responsibility. We want to give you a choice of wholesome and sustainable food at an everyday price.

***During the year, we may serve the veggie balls and salmon with other side dishes that are just as delicious.**



Veggie balls contain no animal ingredients and are a good source of protein, packed with nutritious ingredients that do not contain gluten, soy, nut, egg or lactose.

\$5⁹⁹

Veggie balls with lentil and mushroom ragout.*
A sweet, yet slightly spicy ragout and nutty lentils.

Relaxing

Painting the walls in the same tone as your storage can help create a soothing and calm space.

01 **New LAUTERS/JÄRA**
floor lamp
\$76

02 **KIVIK**
chaise longue
\$750

03

04

01 New LAUTERS/ JÄRA floor lamp \$76. Shade: 100% polyester and steel. Base: Solid acacia wood, painted. Designer: A Wallin Irinarchos/L Widén. Ø45, H135cm. 803.029.42/302.062.12

02 KIVIK chaise longue \$750. Contact areas: Dyed through top-grain leather with a treated, embossed and pigmented surface. Designer: Ola Wihlborg. RA. W90×D163×H83cm. Grann/Bomstad black 701.986.01

03 BESTÅ storage combination with doors \$660. Foil, painted fibreboard, and particleboard. RA. W240×D40×H128cm. Black-brown/Valviken grey-turquoise 291.716.33

04 LANDSKRONA sofa \$999. Contact areas: Dyed through top-grain leather with a treated, embossed and pigmented surface. Designer: Tord Björklund. RA. W204×D89×H78cm. Grann/Bomstad black 890.317.05

RA=REQUIRES ASSEMBLY

Each of us has a unique way of doing things – and relaxing is no different. It could be reading a book on your own or watching a film with your partner. Maybe it's working on a passion project or being close to your kids. The living room is where it all takes place – and there's no such thing as one-size-fits-all. There are no rules or blueprints. And nothing you have to have. It's about crafting a space with the right pieces – ones that fit your special brand of relaxing and recharging.

Dress code: sweatpants

Home is the place where we can be ourselves – sweatpants and all. The outside world stays out with their expectations, schedules and dress codes. Inside is all about recharging and relaxing. When we imagine that room, it looks a bit like this. A soft and serene space with our sofa as the hero – a spot so inviting we never want to leave. Yours might look different – and it should. Because it can be whatever you want it to be.

01 VIVAN curtains, 1 pair \$14.99.

70% polyester, 30% cotton.
W145xL250cm/per panel. 602.975.69

02 SVIRVEL work lamp \$39.99.

Polypropylene plastic and steel. Designer: C Martin/M Elebäck. RA. H45cm. 502.807.53

03 IKEA PS 2014 Floor lamp \$69.99.

Powder coated steel. RA. Ø33cm, H161cm.
602.600.90

04 SÖDERHAMN chaise longue \$450.

53% cotton, 47% polyester. RA.
W93xD151xH83cm. Finnsta white 591.336.73

05 SANDHAUG nightstand \$79.99.

Rattan and powder-coated steel. Designer: D Wahl/A Fredriksson. RA. Ø47, H60cm. 802.691.03

06 ALGOT wall upright/shelves \$176.

Powder-coated steel, particle board, foil and plastic. Designer: Francis Cayouette. RA.
W154xD40xH196cm. 199.296.31

RA=REQUIRES ASSEMBLY



02 SVIRVEL
work lamp
\$39⁹⁹

A table with hidden storage helps manage cables and keep the clutter away. Use as a side table, or a nightstand.

05 SANDHAUG
nightstand
\$79⁹⁹



01 KLIPPAN
loveseat

\$399

03

02

Greenery for the soul

Being out in nature is like a reboot for the soul. It brings us back to a place of calm, where the outside world fades away. Recreating this feeling at home is simply a matter of bringing the outdoors in. Go wild with green plants, which are more than just décor – they also purify the air and minimize stress. Then add some natural materials like rattan, wood and terracotta to make time in this corner feel totally tranquil.



04 New GRÖNADAL
rocking-chair
\$149

05

06

All plants create a soothing environment that helps us de-stress. But some of them do an even bigger job, helping to purify the air around us. Aloe Vera is an easy-to-grow plant that can remove some of the chemicals left behind by household cleaners, while spider plants are hard-to-kill workhorses that remove carbon monoxide and much more.

01 KLIPPAN loveseat \$399.

Cover: 65% polyester and 35% cotton. RA. W180xD88xH66cm. Granån black 898.262.91

02 ALSEDA stool \$39.99.

Banana fibres. Seat Ø60, H18cm. 200.339.19

03 OSTED rug, flatwoven \$89.99.

User surface: 100% sisal. Edge fabric: 100% polyester. 5' 3" x 7' 7" (W160xL230cm) 202.703.12

04 New GRÖNADAL rocking chair \$149.

Clear-lacquered rattan, solid ash and steel. Designer: Lisa Hilland. W57xD82xH86cm. 903.200.97

05 VITTSJÖ shelving unit \$99.

Powder-coated steel, tempered glass and foil finish. Designer: Johan Kroon. RA. W100xD36xH175cm. 202.133.12

06 INGEFÄRA plant pot with saucer \$6.99/ea.

Red clay. Designer: Ann-Carin Wiktorsson. Max. diameter flowerpot 15cm. 302.580.41

RA=REQUIRES ASSEMBLY



01 RIBBA
frame, W31×H41cm.
\$9⁹⁹/ea

02

03

04 SVALSTA
nesting tables, set of 2.
\$99

The dream living room recipe

Beautiful images of the home are delivered into our hands every day – ones that inspire and also intimidate. But getting your dream living room doesn't have to be hard, especially with some simple steps that help turn fantasy into a reality. You can use one to freshen up and personalize your space – or all of them for a true transformation.

- 01 RIBBA frame \$9.99/ea.**
Foil finish and glass. Picture W31×H41cm. Black 603.058.66
- 02 NOCKEBY loveseat with chaise, left \$1459.** 78% cotton, 22% polyester. RA. W277×D97/175×H82cm. Tallmyra rust/wood 691.504.31
- 03 GULLKLOCKA cushion cover \$7.99/ea.** 90% polyester, 10% nylon. L50×W50cm. Grey 602.917.51
- 04 SVALSTA nesting tables, set of 2 \$99.** RA. Sizes: 1 pc 55×45×40cm and 1 pc 73×63×45cm. Stained, clear lacquered ash veneer. Black-brown 602.806.77
- 05 KLABB table lamp \$29.99.** Aluminum and 100% polyester microfibre. Designer: Monika Mulder. H44cm. Light brown 802.687.40

RA=REQUIRES ASSEMBLY



Wall Décor

Creating a gallery wall of your favourite photos and art starts with the frames. Sticking to one or two colours with the same style can offer a look that's clean and timeless. Then hang a few frames at the same height to anchor the arrangement, and add the rest around it. And the most important tip? Be fearless about what you frame – the best gallery walls have a mix of beloved pieces.



Textiles

Picking a scheme of two to three colours in a mix of materials and textures helps create a cohesive, beautiful space. Neutrals bring calm to a room, especially if your furniture and walls are rich in colour. But if the space is more of a blank canvas, then feel free to add a pop of colour – or a few.



Lighting

Placing light sources at different heights around the room can help create a soothing and functional space. In addition to general lighting, task lighting in the form of a reading lamp, and mood lighting from candles or table lamps all work together to create the right feeling for each moment.

Putting your passion first

We all have a passion for something like dancing, sketching, music. But it's usually relegated to a corner or given a temporary spot in the living room. Well, not anymore. It's time to shed old conventions about how this room should look, and instead furnish it around your passion. If you want your living room to be a tango club, then do it – fearlessly. The only rule is - there are no rules.



01 INGATORP extendable table \$369.

Stained, clear lacquered beech veneer.
Designer: Carina Bengs. RA. Ø110/155, H74cm.
Black 802.170.72

02 JENNYLUND armchair \$239.

Cover: 65% polyester and 35% cotton.
RA. W78×D85×H84cm.
Tygelsjö beige 190.473.33

03 STOCKSUND chaise \$689.

Solid beech, Stain, Clear lacquer RA.
W92×D153×H89cm.
Ljungen blue/black/wood 591.293.84

04 MALSJÖ glass-door cabinet \$499.

Stained, clear lacquered ash veneer and tempered glass. Designer: Carina Bengs.
W103×D47×H141cm. Black 603.034.81

05 STOCKSUND loveseat \$799.

Solid beech, Stain, Clear lacquer.
RA. W154×D95×H89cm.
Hovsten grey/white/black/wood 791.297.50

RA=REQUIRES ASSEMBLY

02 JENNYLUND
armchair
\$239

05 STOCKSUND
loveseat
\$799

Do you remember the homes of yesteryear? When more people had rooms dedicated to one specific activity – like a dining room for eating, an office for working and a living room for talking with friends or watching television? Of course, not all homes were like this, but there was certainly more of a tendency to keep rooms and the activities that happened in them distinct.

When the sofa is the home

▼ Dive deeper into our features by downloading the IKEA Catalogue app.

Now, more and more people are rethinking how they use the space they have. For the first time in history, more people live in cities than in the countryside. And in less than 20 years, 70% of the world's population will be living in cities. This reality is having an enormous impact on life at home, and downsizing has been one of the biggest changes we've had to adapt to.

Of course, new ways of living require new ways of approaching the product development and design process. At IKEA, we're constantly trying to find smart and versatile solutions to both needs and dreams. It's about providing real solutions without sacrificing personal style and expression.

One of the biggest changes we've noticed in the home? For many, the living room is now a place to eat, drink, relax, socialize – and even a place where friends or family can stay the night.

So we thought we'd tell you about an idea that helps you do all that, in one product. VALLENTUNA is a brand new sofa that's unlike anything we've made before. We also wanted you to meet some of the many passionate IKEA co-workers – from product developers, development suppliers, pattern shop technician, and designers to packaging engineers and people who specialize in product

construction – that took VALLENTUNA from a vague idea to an actual product that can help you have a better everyday life at home.

At IKEA we often say that what is easy for the customer to use is often complicated to make. "Our motto for VALLENTUNA was that we should follow the IKEA value of simplicity – make construction, production and customer understanding simple. Really, really simple," says Bartosz Jasinski, product development engineer. "The biggest challenge was that we wanted the sofa to have three distinct functions: sitting, storage and sleeping – all of the needs we could imagine for it."

One of the things that solved many of these challenges was a system of holes that connects the parts. It allowed VALLENTUNA to become a versatile tool, a bit like a Swiss army knife, with many functions and possibilities. "You can build it like an island, have it long so it fits against a wall, or transform it into a bed that doubles as a sitting area," says Lisa Hilland, one of the designers involved. "Your 80x100 centimetre sofa can turn into an 80x200 centimetre bed – which is more comfortable," she says.

"We worked with this sofa for over two years – but it's still you who are going to design it," adds Jerry Svensson, the product developer who led the team at IKEA. "With just eight



Above | Your sofa, your way – VALLENTUNA can be configured however you want, however you need. It's about endless possibilities.

Below | Meet the team behind VALLENTUNA – the product developers and experts who brought this new sofa to life.



parts you can build just about anything." Low back or high back? Want an armrest and a back pillow? With a bed or without? Need built-in storage? It's all possible – and the covers, which are either machine washable or coated to be easily wiped clean, even come in both patterns and solid colours. The idea is that customers can create a sofa that's just right for them.

VALLENTUNA sparks creativity and encourages you to build your own sofa – or sofas. Or bed. Or storage solution. VALLENTUNA is made for the living rooms and homes of today. And we think it will stay there for many years to come. ■



"The biggest challenge was that we wanted the sofa to have three distinct functions: sitting, storage and sleeping – all of the needs we could imagine for it."

Bartosz Jasinski, Technical specialist

Left | Seating, sleeping – and of course, storage. Built-in compartments mean you can keep bedding and linens tucked out of sight until you need them.

The 24-hour life of a sofa bed

As many migrate to cities, smaller spaces have become the new dream home. And part of the reason is that small is smart. The sofa bed is the heart of this living room, made for socializing as much as snoozing. When you add a folding table that doubles as a desk, a chair that's also wall décor and a bench, you have plenty of room for a refined, urban tea party with friends. Pinky fingers up.



01 HOLMSUND sofa bed

\$849

02

03 BJURSTA bench

\$149

04 New VARDAGEN teapot
\$999

01 HOLMSUND sofa bed \$849. Cover: 100% polyester. RA. W230×D91×H96cm. Bed size 140×200cm. Nordvalla medium grey 191.555.15

02 New ÄNGSTÖREL bedspread \$19.99. 100% cotton. W150×L250cm. 203.280.92

03 BJURSTA bench \$149. Stained, clear lacquered ash veneer. RA. W158×D36×H45cm. 402.590.40

04 New VARDAGEN teapot \$9.99. Stoneware. Designer: Preutz/Wihlborg/Braasch/Karlsson. 1.2L. 402.893.44

05 INGATORP drop-leaf table \$159. Stained, clear lacquered solid pine. Designer: Carina Bengs. RA. L59/88/117×W78×H73cm. 202.214.25

RA=REQUIRES ASSEMBLY

Chaos-free company

The living room is a busy place. It's a snug spot for relaxing, a hub for socializing as a family, and the room of choice for everyone to do their own thing. In a big family this could easily lead to clutter and chaos, but it doesn't have to. Comfortable yet clever seating for every butt in the house, and smart storage for tidying up diverse interests creates space for what truly matters – getting all those butts together.

01 POÄNG rocking chair \$339.

Cover: Dyed through grain leather. RA. W68×D82×H100cm. Birch veneer/Seglora natural 391.506.25

02 New VALLENTUNA 3 seat sectional \$1070.

65% polyester and 35% cotton. Designer: Fredriksson/L Löwenhielm/Hilland. RA. W260×D113×H84cm. Hillared dark grey/Orrsta light grey 791.853.69

03 BILLY bookcase \$104.

Foil, painted fibreboard, and particleboard. RA. W80×D28×H237cm. White 591.822.01

04 New VALLENTUNA 2 seat sectional \$720.

85% cotton and 15% polyester. Designer: Fredriksson/L Löwenhielm/Hilland. RA. W186×D80×H104cm. Funnarp black/beige 991.853.68

05 LISABO coffee table \$199.

Clear lacquered ash veneer and solid birch. Designer: K Hagberg/M Hagberg. L118×W50×H50cm. 702.976.58

RA=REQUIRES ASSEMBLY



Assembly service. We can help you to assemble your new furniture. Prices from \$79. See page 309.



Climbing and cuddling

Precious moments with our kids are the memories that stay with us. But in the everyday, it can be hard to find time for those moments. So we came up with an unconventional fix. We brought the bunk bed out of the kids' room and put it in the living room – giving it a refined and mature aesthetic. It's part jungle gym and part cozy sofa, a piece that lets kids be kids and adults be adults – together.

01 KALLAX shelving unit \$159/ea.

Clear lacquered, printed finish. Designer: Tord Björklund. RA. W147×D39×H147cm. Black-brown 102.758.62

02 NORSBORG corner sofa 2+2 \$1645.

53% cotton, 47% polyester. Painted solid birch. RA. W225/225×D88×H85cm. Finnsta white/grey 891.251.53

03 TUFFING twin bunk bed frame \$169.

The mattress must not be more than a total of 12cm thick in order not to exceed the safety marking on/by the upper part of the ladder. Mattress and bedlinens sold separately. Steel and polyester. RA. W103×L197×H130.5cm. 702.992.85

04 RISSNA coffee table \$129.

Painted finish and stained, clear lacquered solid beech. Designer: Ola Wihlborg. RA. Ø90, H40cm. Beige 202.972.41

05 New SATTRUP rug, flatwoven \$169.

79% jute, 21% sisal. Designer: Paulin Machado. 5' 11" × 7' 4" (W180×L224cm) Natural 002.852.58

06 HEKTAR wall/clamp spotlight \$19.99/ea.

Powder coated steel. RA. Ø11cm. Dark grey 502.165.40

07 BJURSTA Bench \$149.

Stained, clear lacquered ash veneer. RA. W158 ×D36 ×H45cm. Brown-black 402.590.40

RA=REQUIRES ASSEMBLY



03 TUFFING
twin bunk bed frame
\$169

05 New SATTRUP
rug, flatwoven
\$169



The backyard comes inside

A grassy outdoor spot is a great place for kids to run, jump, hide and tumble. But it's not the only one. The great indoors are a safe spot for fun and games – with the right details. A storage wall in this mature living room hides away all of the ingredients of play, while hooks can turn toys into decoration. Now playtime can happen any time – and adults are welcome too.

Assembly service. We can help you to assemble your new furniture. Prices from \$79. See page 309.



01 IVAR 4 sections with shelves \$428. Solid pine. RA. W344×D30×H226cm. 498.977.61

02 ARKELSTORP coffee table \$149. Stained, clear lacquered solid pine. Designer: Ebba Strandmark. RA. L50/140×W65×H52cm. 302.608.07

03 EKTORP sofa \$599. Cover: 100% polyester. RA. W218×D88×H88cm. Nordvalla light blue 991.277.74

04 LENDA fabric \$5.99/m. 100% cotton. W150cm. 601.206.36

05 TRÄNING juggling set \$29.99. Includes: 3 balls, 3 rings, 3 juggling clubs and 1 storage net. 100% polyester, 77% nylon, 23% elasthan/spandex. Filling: Polypropylene, High resilient polyurethane foam. Recommended for children 3 years and older. 702.589.54

06 IKEA PS 2014 balancing bench \$69.99. Solid birch, clear acrylic lacquer. RA. L140×W27cm. Recommended for children 3 years and older. 402.629.57

07 PLUFSIG folding gym mat \$49.99. Recommended for children 18 months and older. 100% polyester, 100% PEVA. Designer: Tina Christensen. L185×W78cm. 902.789.27

RA=REQUIRES ASSEMBLY

A curtain that you paint yourself is an inspiring backdrop for play. But it might not go with mom and dad's grown-up aesthetic in the living room. Two curtains can make both sides happy. With a triple-track rail, you can have a beautiful curtain on the outside and a play curtain on the inside that's hidden away until it's time for fun and games again.

It's known that home is what you create, not necessarily what you buy. It's not about the place, but the actions that take place. The person next to you might say, "It's just furniture though, home is where your heart is". We recognize that home, whatever this is to you, has an important place in your life. Therefore, to us, furniture is not just furniture. It facilitates your way of living, and contributes to your unique idea of home. It's there by your side throughout all different stages of life – the planned, and the unexpected. But, the way we live is changing: life becoming more fluid, and the world seemingly smaller. So we're curious: What makes a home a home? We spoke to four individuals for a more personal point of view.

What makes a home a home?

NAME: Anna
WORK: Business Development & Sales
LIVES: Copenhagen, Denmark

Born in Hong Kong with most of her childhood spent in New Zealand, Anna has created a new life for herself in Copenhagen, at a co-living space. In the midst of the hip city, 21 entrepreneurial innovators are sharing four apartments. Together they host dinner parties, organize movie screenings, and discuss



everything from life's twists and turns, to business and relationships. It was during a university competition that she first discovered Denmark, and has since travelled back and forth for eight years for what she calls a "recharge". Finally she decided to quit her job as a financial analyst and make the move. Today she works with sales and business development at a start-up that converts clothing sizes for online shops. Although she's travelled a lot, and finds herself more "rooted" nowadays, she describes her dream living situation as being a digital nomad with, not one, but three homes.

What is home for you?

"Home is where the heart is. And for me, it's also family, and now with age, my friends too. For the longest time I would think of New Zealand as my home, but now that my parents live in Hong Kong it's different. Copenhagen is also my home, and I consider these people I share this space with my family, rather than my friends. I've built such close bonds with them, and I know I can rely on them."

What makes a home a home?

"When my inner child can come out." She

bursts out smiling as she reminisces about a childhood memory, something she still does as a young adult. "I think, being comfortable with the people around you, that's what makes a home."

Has technology affected your perception of home?

"Absolutely, I video-chat or call my family once or twice every week. I actually message with my brother every day. That makes me feel like we're not that far apart. For me technology has changed everything. Without it I'm not so sure I'd constantly be moving as I have."

If you could bring five things with you, what would they be?

"The network I've built here, the colour orange, because that's the colour of our co-living space", she laughs, "peoples' drive and the work-life balance. Even though the people living here are all entrepreneurs, they really do have a life. I think that's something the Nordic countries do really well. And lastly, my boyfriend! I'm very detached to physical things. I can't say that my room here reflects my personality. I only really go there to sleep." ■



NAME: Mohammed
WORK: Artist & Music Producer
LIVES: Malmö, Sweden

An artist and a music producer, Mohammed (mostly known as Saint, a childhood nickname) was born and raised in Gambia. He came to Malmö, Sweden as a refugee at the age of 15. He describes his first impressions of Malmö as crazy and very foreign, but with a lot of nice people. Today, he's a student at a music high school, well, not your typical student he'd say, and the leader of a music production workshop for refugee kids. When he isn't in school or at work, he's producing music or cooking (or doing both at the same time). Although neither the refugee accommodation, nor the first tiny apartment in the southern part of Malmö felt anything like home, this one, the apartment he's lived in for the past nine months, is beginning to feel like a piece of his own.

What's home for you?

"That's a really good question. I think I'll always refer to Gambia as home, no matter what. Everything feels pretty temporary now, even though I could see myself

"I guess you could say that home is where your mind is at ease. Where you're comfortable. Not worried."

Mohammed



living here for a longer period of time. But you never know. I wouldn't mind moving to another place for a different reason. I've been through so much that I don't mind being disconnected anymore."

What makes a home a home for you?

"Probably the feeling of familiarity. Yeah that's it. To say that music makes my home would be too cliché, but I'll always love music. I mean, I try and incorporate African sounds in my work as much as possible. I know I can recreate the feeling of home anywhere. I'm like a master at that now. When I first moved here, into this apartment, I didn't even buy a mattress. I went to IKEA to buy one and I'm really bad with measurements," he smiles, and tells us about his trip to the big department store, 15 minutes before closing. "So of course we bought the wrong mattress size," he laughs. "So I slept on the couch a lot to begin with, and basically lived in the kitchen. I'd do everything there, chill, eat and record."

Are there things, memories or places that are special to you in relation to your home?

"Umm," he shakes his head before stating, "not really. Even at 'home home', where I'm from in Gambia, I have these blurry visuals of it. Some of them are strange, some made up, and some fairly vivid. It's not just one specific thing; it's a bunch of things. Like when I hear a song that I might've

Left | Mohammed spends most of his time in his kitchen, a space for both creation and cooking.

heard, or remember hearing as a kid in my Pop's car, or anywhere else. It'll remind me of that moment. That feeling. Then I'll try to recreate that feeling in some way. I'll try and recreate a moment from home."

Has technology affected your perception of home?

"No, technology has nothing to do with home for me. I mean I use it on a daily basis, but it doesn't change how I perceive home, or how I see what home should be. I get in touch with Gambia through social media, but you can't exactly call. Of course I'd feel differently if I didn't have the access, but for me it's more about experiencing a place and people. I value that more. On social media I'm not actually physically there - I'm just talking."

What five things would you bring with you from home?

"I would say, good memories, most definitely. Nobody wants a bad memory from home. And comfort, of course. I'd absolutely have to take my ramen noodles with me," he laughs out, "and my shades!" He pauses while thinking hard on a fifth thing to bring, before saying: "Music. Everywhere I go." ■





NAME: Ineke
WORK: Entrepreneur & Designer
LIVES: Hilversum, Netherlands

Meet Ineke and her husband, Guido, living with their three kids and four cats in Hilversum, a small town outside of artsy Amsterdam. Ineke, born and raised in a small rural area in central Holland, met Guido while working as an interior stylist for a DIY TV show. Today, she has her own business knitting furniture, and sits on a snack-tasting panel three days out of the week. Eating crisps nine o'clock in the morning is one of many things that seem to add to the pure happiness that Ineke radiates. Guido also has his own business, as a carpenter and plumber. By the looks of their space it's obvious he's nothing short of a handyman.

How long have you been living here?

"About 20 years now. When we first got here it was really depressing, dark and smelly," Ineke frowns, "it was what we could afford, and I remember thinking to myself: Oh my gosh, how am I going to make this a nice place? We stripped the whole house. There was even a time when we were sleeping on the floor," she points to the center of their, now quaint, living room, "and you could actually see the sky. The entire neighbourhood was getting new roofs. We'd lay and watch the stars at night", she chuckles.

"We saw potential in being able to create and build a lot of things on our own," Guido says, "I don't want it to be overdressed or perfect. That's why the walls are plastered and not flat." Between the charm of the uneven walls it's obvious that they cherish their space as something self-made. It's also how their idea of home has come together, reflecting their personalities. "I'm really a bit of a collector, I can't bring myself to throw away old stuff", Ineke smiles.

What do you think of when you hear the word "home"?

"Cozy and warm, Ineke answers confidently, "It's a feeling. It's my family, definitely. Although I work a lot, more than anything else I'm a mother. I really love spending time with my kids. That's my thing actually." Guido agrees: "Home is family, and some kind of relief – that feeling like, 'ah, I'm home'."

What makes your home special to you?

"That almost everything is self-made," Guido answers. Ineke nods, "I think it's the relaxed atmosphere. It doesn't have to be neat or perfect. For us it's about lighting the fireplace, pouring a glass of wine and cooking a lot of food – that's home. Everyone is welcome here."

When did you start seeing your home as a part of your life?

"I think when I was living in Amsterdam. I bought a house, and for the first time I realized, that house made me happy. Just being there. Before that, when I was studying, home was just a room where you cook, eat and sleep. That first house had a fireplace and a garden, which was special for me. During that time I also started going to auctions to collect things. It's the first time I really made an effort to make home my own." ■

Below | The family gathered in their kitchen is an important ingredient of home for Ineke and Guido.



"Some people feel stressed because they don't have this classical feeling of home – one that is unmovable, and always the same. But I really think that that is slowly being re-defined. I think the world will benefit from that."

Eric

NAME: Eric
WORK: Business Development & Expansion
LIVES: Copenhagen, Denmark

From one home to another, Eric really embodies the essence of a digital nomad. He has spent most of his life moving around, traveling from one place to the other – France to Sweden, to Canada, Norway, and Sri Lanka. With a Swedish mother and a French father he describes his view on home as a way of life. Today he works at a start-up company that aims to make online second hand trading and upcycling fun and easy. It's been eight months since he moved to Copenhagen, but it only took one week for the co-living space to feel like home.

What's home for you?

"It's a sense of calm. Since I've been traveling a lot, home is where I actually relax. That's the first thing that comes to mind. It's of course my room, my desk, my bed, but it's also how I move around in my life – when I go to the store, when I meet my friends in cafés, or when I go to certain bars that I like. It's a way of being. I moved a lot as a kid, so I think I learned a lot about home by experiencing that. In some sense, I think I also like it. I've also made choices that have forced me to change homes a lot as well."

Has technology affected your perception of home?

"No, not the basic feeling of it. The feeling of a home has stayed the same for me, because I think that home is based on feelings. It has however changed how I live at home, for sure. So I'll be listening to music in different ways, and I'll have access to tools that simplify my life. But then there are certain aspects where I try to keep away from technology, so that I'm able to just have the pure sensation of an experience. An example of this would be cooking. For me it's meditation."



Where do you see yourself in 10 years, is there an ideal home?

"I have an idea of places that I like, but I guess I'm not the typical Swede in that sense that I know exactly the kind of home I want in the future. And I'm not going to give you a "family"-answer. I know I'd want to live in a city, and then have a place that is calm to go to during the weekends. It's more of a dream lifestyle, rather than a home, I guess. It'll still be a feeling for me, maybe a mix between a physical place and my relationships in that place. Now my relationships are spread all out. I'm not sure I will own a home. I know I won't own a car. I'll be carpooling and those kinds of things. I think there might be similar solutions for homes in the future." ■

Above | Eric in one of four common kitchen and dining areas where they cook, eat and hang out together.

Made to look like it's the first time, every time



The NORSBORG sofa not only comes with machine-washable covers. Inside, a high-resilience foam provides comfortable support and regains its original shape when you stand up. You don't even have to fluff up the cushions.

NORSBORG loveseat with chaise longue \$965. Was \$1070. 52% polyester, 48% cotton. Tinted, lacquered solid birch. Designer: Ehlén Johansson. RA. W231×D88/157×H85cm. Edum light blue 691.249.70
Shop online at [IKEA.ca](https://www.ikea.ca)

Sharp thinking



As every great chef knows, you should never underestimate the value of the finishing touch. Like the grooves on the handle, to give you a secure, firm grip as you cut, chop and slice your way to dinner.

IKEA 365+ utility knife \$14.99. Stainless molybdenum/vanadium-steel. Designer: Preutz/Wihlborg/Braasch/Karlsson. Length of knife blade: 14 cm. 102.835.17
Shop online at [IKEA.ca](https://www.ikea.ca)

Organizing

Organizing is a challenge we all share – even the most enthusiastic tidier. And while there is no magic potion that effortlessly arranges your things (we wish there was), we have some easy-to-implement ideas for the life you actually have. Ideas like creating a closet or a home office where there was none. And storage that hides cords or displays your most cherished memories. These are solutions that understand organizing can be a chore – but doesn't make it feel that way.



01



04 VALJE shelf unit

\$129

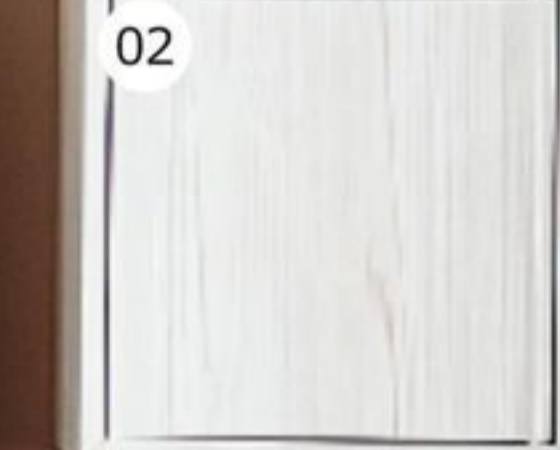

03

**01 VALJE wall cube \$29/ea.**

Foil finish and plastic. Designer: Jon Karlsson. RA. W35×D30×H35cm. White 902.796.15

02 VALJE wall cabinet with 1 door \$39/ea.

Foil finish and plastic. Designer: Jon Karlsson. RA. W35×D30×H35cm. White 702.795.98

03 VARV floor lamp with pad/ wireless charging \$129.

Charges a compatible Qi-enabled smartphone when you place it on top. Includes a USB port for non-wireless charging. Steel, plastic, 82% nylon and 18% polyurethane. Designer: Eva Lilja Löwenhielm. RA. H169cm. 202.807.02
VITAHULT Qi-enabled charging cases sold separately.

04 VALJE shelf unit \$129.

Foil finish and powder-coated steel. Designer: Jon Karlsson. RA. W100×D30×H83cm. White 202.796.09

RA=REQUIRES ASSEMBLY

Stashing the tech

Digital devices are an integral part of our lives. Smart solutions that allow you to effortlessly charge and organize them should be, too. So we came up with a few ideas – like a coffee table with shelves to store devices you’re using. Or TV storage where you can stash or charge the ones you’re not. Instead of floating around, every device has a home of its own – until you’re ready for more digital diversion.



01 BESTÅ storage combination with drawers \$260. RA. W180×D40×H48cm. Black-brown/Valviken dark brown 891.364.82

02 BESTÅ storage combination with doors/drawers \$240. RA. W120×D40×H74cm. Black-brown/Valviken dark brown 091.365.70

03 VARV table lamp with wireless charging \$79.99. Steel, plastic, 82% nylon and 18% polyurethane. Designer: Eva Lilja Löwenhielm. RA. H52cm. VITAHULT Qi-enabled charging cases sold separately. 702.807.09

04 BESTÅ box \$10. 100% polyester. 25×D31×H15cm. Grey 003.075.52

RA=REQUIRES ASSEMBLY

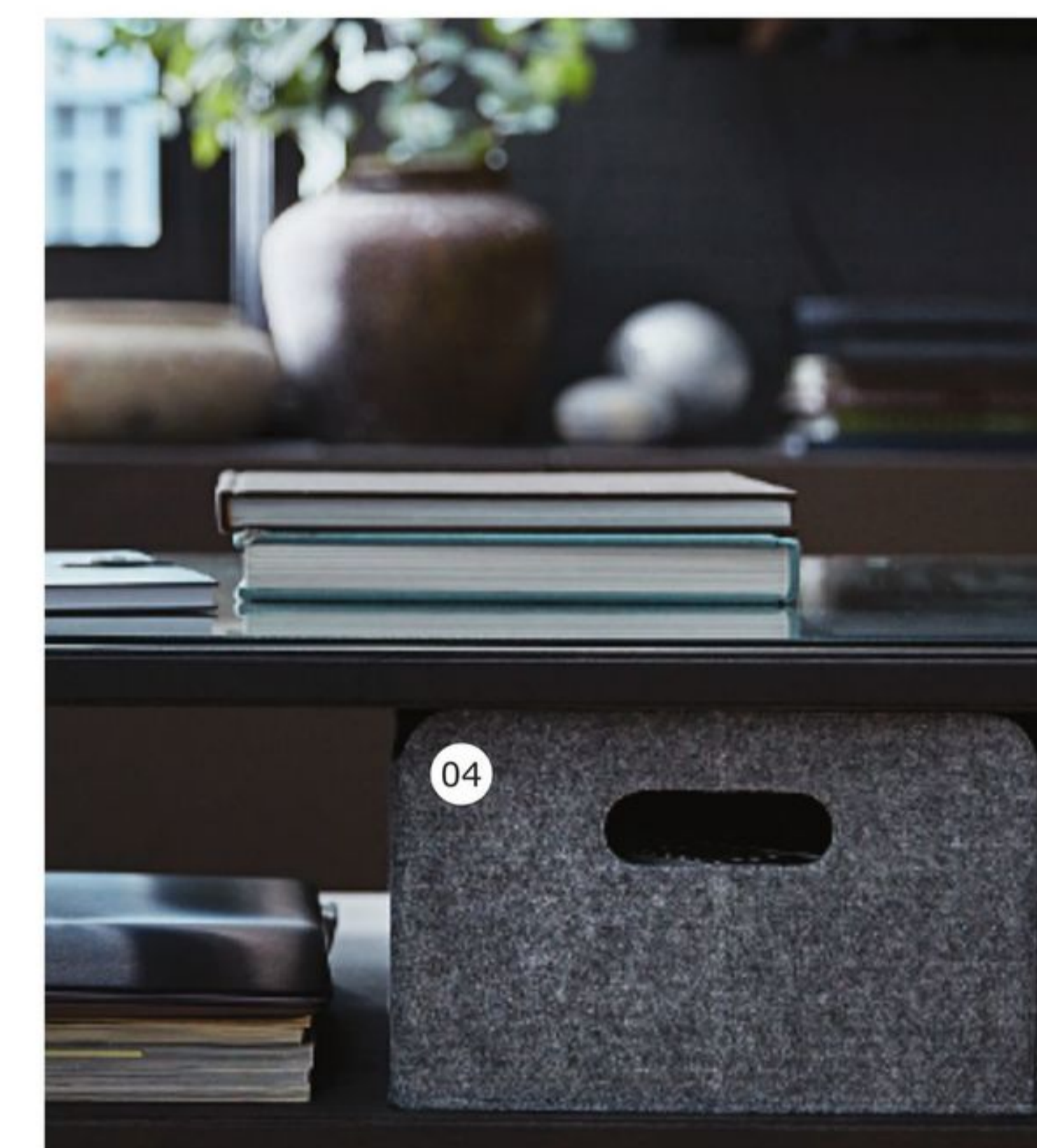

Here are three ideas to help you better manage your tech. Shelves under a coffee table are an out-of-the-way place to stash devices you’re still using, but don’t want to have out. Soft drawer inserts can take care of the devices you want to put away. And a lamp with built-in charging and a USB port can top up power on phones or tablets before you fire them up again.



02 BESTÅ storage combination with doors/drawers \$240



Where work meets play

When your home is your office, a great workspace helps put you in the right frame of mind for your 9-to-5. Getting a professional and sleek office doesn't require another room though – just a corner of your entertainment wall. Integrating a desk with ample room and cabinets that put office essentials at your fingertips make your workday a productive one. And you can't beat the commute home – about three seconds from desk to sofa.

Picking with Delivery service. We collect all your purchased items and deliver them to you. Prices from \$99. See page 309.



01 BESTÅ TV storage combination \$970. Foil, painted fibreboard, and particleboard. RA. W460×D40×H192cm. White/Lappviken white 591.716.36

02 FORSÅ work lamp \$24.99. Powder-coated steel. RA. H35cm. Black 801.467.77

03 ALEX desk \$169. Painted finish and powder-coated steel. Designer: Johanna Asshoff. RA. W131×D60×H76cm. White 402.607.17

04 BILLY/OXBERG bookcase \$455. Stained, clear lacquered ash veneer. RA. W120×D28×H237cm. Brown 591.776.24

05 STOCKHOLM pendant lamp \$149. Powder-coated steel, polyethylene. Designer: Ola Wihlborg. RA. Ø55, H23cm. White 902.161.33

06 BILLY bookcase \$110. Stained, clear lacquered ash veneer. RA. W40×D28×H237cm. Brown 091.776.26

07 New KULLABERG swivel chair \$69.99. Moulded eucalyptus and powder coated steel. Designer: Sarah Fager. RA. Seat W42×D39×H44–55cm. Black 903.255.18

RA=REQUIRES ASSEMBLY

No more manic mornings

The hallway can be harmonious, a calm space for getting ready to leave the house. It turns what could be a stressful moment of the day into an indulgent one that's all about the finishing touches. Beautiful and transparent storage gives your coats, scarves and shoes a place of their own, and puts them on display. It's about elevating the little things – and bringing some tranquility to your mornings.

01 HEMNES hook \$5.99/ea.

Zinc. H9×D15cm. Anthracite 702.510.71

02 MALSJÖ glass-door cabinet \$399.

Stained, clear lacquered ash veneer and tempered glass. Designer: Carina Bengs. RA. W60×D40×H186cm. Black stained 303.034.87

03 STOCKSUND bench \$269.

75% cotton, 25% polyester. Stained solid beech. Designer: Nike Karlsson. RA. W144×D49×H47cm. Nolhaga grey-beige/black/wood 890.336.29

04 KARMSUND table mirror \$49.99.

Was \$54.99-. Powder-coated steel and mirror glass. Designer: A Efverlund/C Ke. RA. W80×H74cm. 202.949.83

05 KLIMPEN table top \$69.

Painted finish. Designer: Tina Christensen. L120×W60cm. Black 802.777.68

LALLE leg \$15/ea. Painted solid beech. Designer: Tina Christensen. H70cm. Black 402.378.40

06 UNDREDAL wardrobe \$469.

Painted finish and tempered glass. Designer: Ebba Strandmark. RA. W102×D62×H203cm. 202.976.46

RA=REQUIRES ASSEMBLY



Bringing the boutique home

Small homes are not exactly known for their ample wardrobe space. Usually it's a tiny box more suited to brooms than blazers. But what if you didn't need that wardrobe? Using open storage as a room divider gives a room a spacious, boutique-like feeling. You can quickly see everything you have, making it easier to decide and get dressed. You'll just have to remind your friends that nothing here is for sale – except the storage system itself.



01 SEKOND/SOLLEFTEÅ
cord set and shade
\$16⁹⁹

01 SEKOND/SOLLEFTEÅ cord set and shade \$16.99. Rice paper, steel and textile. Designer: Maria Vinka. RA. Ø37, H23cm. Cord length 4.7m. Shade and cord set sold separately. White 002.637.08/503.001.24

02 KUBBIS rack with 7 hooks \$15.99. Solid wood. Designer: Nike Karlsson. RA. L105cm. White 102.895.76

03 NORDLI 6-drawer dresser \$289. Possible to build different combinations. Particleboard, Acrylic paint. RA. W120×D43×H52cm. White 091.621.87

04 New ELVARLI clothes/shoe storage combination \$659. Possible to build different combinations. Lacquered aluminum. Designer: Ehlén Johansson. RA. W173×D51×H222–350cm. White 491.575.46

05 New FLÅDIS basket \$19.99. Seagrass. Ø37, H41cm. 003.221.71

RA=REQUIRES ASSEMBLY

Assembly service. We can help you to assemble your new furniture. Prices from \$79. See page 309.



04 New ELVARLI
clothes/shoe storage
combination
\$659

Wear what you love

Creating some order in a packed wardrobe can be an intimidating project. There are a lot of ways to organize – and there is no right or wrong. Luckily, there is one habit we all share: we wear what we see. Applying this simple principle to your wardrobe organization opens up a world of possibilities. Get ready to rediscover your wardrobe – and get dressed a whole lot faster.

01 New PAX wardrobe \$720. Foil finish and high-gloss foil finish. RA. W150×D60×H236.4cm. White/FARDAL high-gloss/light green 491.586.83

02 HOVET mirror \$129. Mirror glass and aluminum. W78×H196cm. 500.382.13

03 SKUBB box, set of 6 \$9.99. 2 of each size: W14×D14×H13cm, W28×D14×H13cm, W28×D28×H13cm. 100% polyester and polypropylene plastic. Designer: Monika Mulder. White 001.926.31

04 STÖTTA LED light strip, battery-operated \$19.99. Built-in LED light source. Plastic. Designer: David Wahl. L75cm. AA batteries sold separately. 802.771.36

05 TJENA box with lid \$4.99. Paper. RA. W27×D35×H20cm. White 402.636.26
TJENA box with compartments \$3.99. Paper. RA. W27×D35×H10cm. White 002.636.14

RA=REQUIRES ASSEMBLY

01 New PAX wardrobe \$720

02 HOVET mirror \$129

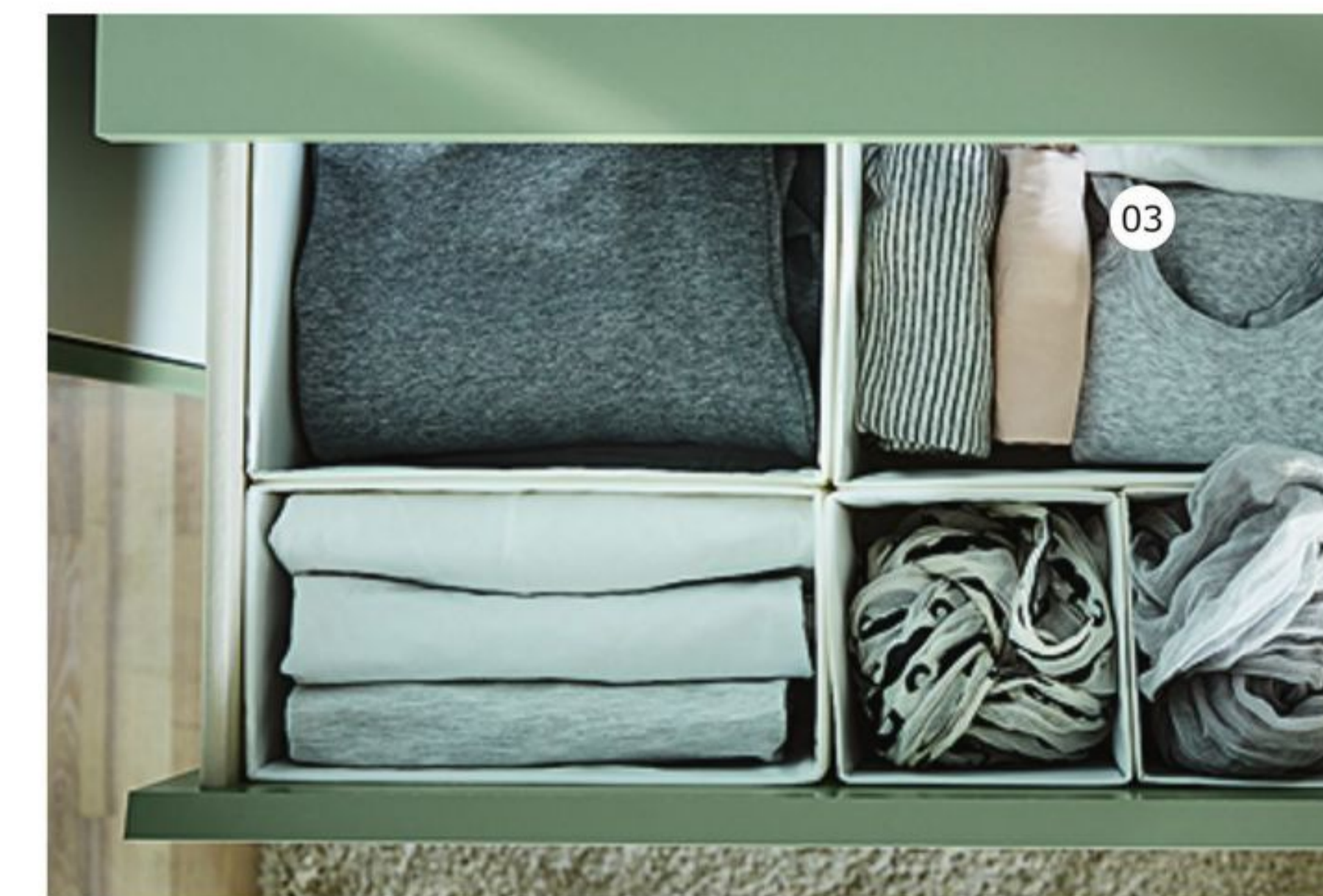

Drawers

Vertically storing things like T-shirts, jeans and sweaters can help you see every garment you have. For the smaller items – like scarves or socks – boxes or dividers give you an orderly overview.



Lighting

You can't wear what you can't see. Illuminating your clothes with sensor or cabinet lighting can make it easier to pick out individual pieces – day and night.



Seasonal

Taking seasonal clothes out of the wardrobe and storing them in boxes can help free up precious room on your rails and shelves for the pieces you're more likely to wear now.

The low-cost dream wardrobe

A big wardrobe that displays our clothes and gives everything a place of its own is a fantasy for many. But big wardrobes come with big price tags, don't they? Not in our world. This is the low-cost dream wardrobe, with many of the features, functions and sophisticated details you've always envisioned. With soft curtains, long rails, show-off shelves and a bit of sparkle, reality just got a lot closer to your dreams.

01 SANELA curtains, 1 pair \$79.99/2 pack. 100% cotton velvet. W140xL250cm/per panel. Brown 302.301.89

02 ÖRTOFTA chandelier \$149. Steel, glass. Designer: David Wahl. RA. Ø42, H50cm. 102.455.73

03 BRIMNES glass door cabinet \$99. Foil finish and tempered glass. Designer: K Hagberg/M Hagberg. RA. W39xD22xH142cm. Black 203.006.58 Lighting is sold separately.

04 TURBO clothes rack, indoor/outdoor \$49.99/ea. Wood plastic composite. Designer: Marcus Arvonen. RA. W117xD59xH148cm. Black 401.772.33

05 KARMSUND standing mirror \$59.99. Powder-coated steel and mirror glass. Designer: A Efverlund/C Ke. RA. W40xH167cm. 402.949.82

06 LACK wall shelf \$29.99/ea. Clear lacquered, printed finish. RA. L110xD26cm. 701.591.00

07 KALLAX shelving unit \$99.99. Foil and painted finish. Designer: Tord Björklund. RA. W77xD39xH147cm. Black brown 202.758.85 Boxes are sold separately.

RA=REQUIRES ASSEMBLY



The no-drill wardrobe

For renters, more functional and flexible storage is a big wish – no matter how long they stay. Landlords, on the other hand, wish for fewer holes in the wall. So we challenged ourselves to try and make both a reality. This is the no-drill wardrobe, a low-cost combination of lightweight clothing racks, boxes and flexible metal cubes. It is a solution that makes a rental feel more like home – for now.

01 SAMLA box \$2.99. Polypropylene. W38×D28×H14cm. 11L. 401.029.78
SAMLA lid \$2. Polypropylene. 501.102.99

02 KNAPPER standing mirror \$49.99. Mirror glass and powder-coated steel. Designer: N Cortolezzis/D Wahl. RA. W48×H160cm. 002.173.87

03 MULIG clothes rack \$12.99/ea. Powder-coated steel. Designer: Henrik Preutz. RA. W99×D46×H151cm. White 601.794.34

04 SKUBB organizer with 6 compartments \$9.99. 100% polyester and polypropylene plastic. W35×D45×H125cm. White 002.458.80

05 New LIXHULT cabinet \$40/ea. Powder-coated steel. Designer: Jon Karlsson. RA. W60×D35×H35cm. Metal/grey 703.286.69

RA=REQUIRES ASSEMBLY



Tidy toys, happy parents

The living room is the together room – a place for parents to unwind and kids to play. But in many homes, playtime is when the toy box explodes with books, blocks and stuffed bears. Handsome toy storage can be hung low or placed on the floor, making it easier for kids to reach. This way clean-up can happen as a family – a moment of togetherness that also restores a bit of sanity.

01 New FLISAT book display \$24.99.
Tinted, clear lacquered solid pine. RA.
W49×D28×H41cm. 002.907.83

02 New FLISAT toy storage with casters \$39.99/ea. Tinted, clear lacquered solid pine. and plastic. RA. L44×W39×H31cm. 102.984.20 TROFAST storage box sold separately.

03 New FLISAT doll house/wall shelf \$39.99. Recommended for children 3 years and older. Tinted, clear lacquered solid pine. Designer: S Fager/J Karlsson. RA. W58×D22×H59cm. 502.907.85 Doll furniture sold separately.

04 STUVA storage bench \$99/ea. Foil and painted finish. RA. W90×D50×H50cm. 398.766.60

05 New FLISAT children's table \$74.99. Tinted, clear lacquered solid pine. RA. L83×W58×H48cm. 502.984.18 TROFAST storage boxes sold separately.

RA=REQUIRES ASSEMBLY



A no-compromise nursery

Bringing home a baby also means bringing home a lot of stuff. And in a small space that can lead to big sacrifice. But adding a nursery in your bedroom doesn't have to mean giving up your meticulous wardrobes. So we created the nursery wall, a space that maximizes the room you have with individual wardrobes for all, a changing station and a crib. It's an organized spot where you can change your clothes – and the baby too.

01 SEKOND/KRUSNING shade and cord set \$28.99. Paper, plastic and textile. RA. H55, Ø85cm. Cord length 4.7m. Shade and cord sold separately. White 002.637.08/502.599.21

02 STUVA crib with drawers \$299. Mattress and bedlinens are sold separately. Foil and painted finish. RA. W74×L139×H92cm. Mattress size 70×132cm. Birch effect 790.324.42

03 STUVA storage combination with doors \$224. Foil and painted finish. RA. W60×D50×H192cm. Birch effect 190.326.85

04 STUVA changing table with 3 drawers \$234. Foil and painted finish. RA. W90×D79×H102cm. Birch effect 791.240.31

05 PAX wardrobe \$570/ea. Foil and painted finish. RA. W100×D60×H236.4cm. White/TANEM white 191.671.94

RA=REQUIRES ASSEMBLY



Swedishness has no borders

I didn't know much about the Swedish culture when I applied for a job to work at IKEA in Älmhult, Sweden. But, after five years as a copywriter in "the heart of IKEA," it seems that some Swedishness has rubbed off on me.



Despite moving back to America, I've developed a strong affinity for white walls, unfinished wood, the warmth of tealights, and placing carved Swedish Dala horses on practically every free shelf and windowsill in my home. Light-coloured walls and candles fight the dark winter's never-ending grey weather, which is not unlike Sweden here in Portland, Oregon, while wood makes me feel closer to nature. I blame my long walks in the Swedish forest for that.

But it goes much deeper than home furnishing. If I could sum up Swedishness in one or two words, it would be simplicity. Simplicity as an approach to life. And heart.

It sounds so nice. Almost too nice. But it didn't always make sense to me. In the beginning, I found it strange that, all around Sweden, shops closed at 5 or 6 p.m. during the week and by 2 p.m. on Saturdays (and they didn't even open on Sundays). At first, I wondered why the shop owners didn't want to make money. Then I realized they just valued their time with their families more. It's why parents get 16 months of parental leave when their children are

born. Caring for each other is a priority, and it starts right at birth.

At work, people felt more like family than co-workers (and still do). There were no egos. There was no hierarchy. This made working in a corporate environment quite refreshing, but it also meant that decisions were made by committee. In other words, they weren't made very quickly. But everyone worked together, respected each other and had fun. Despite the hard work, people came first. Life came first. You could say the stuff that matters most came first.

I've often reflected on my time working there and wondered if what I experienced was because I was living in Sweden or working at IKEA. The line always seemed blurred to me. Was it the Swedish culture or the IKEA culture?

Last year, a project in the Netherlands helped clarify that for me. I was asked to work on internal communication ideas around IKEA core values at the IKEA head office in Delft. I would be working with a team of Dutch co-workers that I had never met, and I was the only one from outside the office.



Above | While it might not be 100% Swedish to hang advent stars year-round, giving the kids their own spaces to play alongside us definitely is. The HEMNES TV bench is the perfect worktop height for them to "cook" their own masterpieces.



"If I could sum up Swedishness in one or two words, it would be simplicity. Simplicity as an approach to life. And heart."

Ginny Figlar, copywriter

There is some kind of magic that happens when you brainstorm ideas with people you are comfortable with. There is a trust there, and knowing how everyone works helps you get to those hard-to-reach, really good ideas. So I was pretty nervous when I arrived to meet everyone for the first time at the kick-off meeting.

But from the moment we were all together in the same room, I felt an overwhelming sense of familiarity. It was as if I had worked with these people for years. The same things I experienced in Sweden were happening right then and there.

Swedishness was coming to life all around me – it wasn't just about Sweden anymore. It was about values, and values don't have borders. They live inside each of us and thrive on being connected. That way you just click with some people.

That's when I realized – it's IKEA. ■

Below | It's about simplicity and the little things... like these notches that let water drain off when the mug is upside-down in the dishwasher.



Be good to your food



BLANDA MATT
serving bowl
\$19⁹⁹

The BLANDA bowl is made from bamboo, an easy-care, hard-wearing material that will look good on the table, while also making the foods you put in it look irresistible.

BLANDA MATT serving bowl \$19.99.
Clear lacquered bamboo. Designer: Anne Nilsson. Ø28cm. 602.143.43
Shop online at [IKEA.ca](https://www.ikea.com)

Could your room use some more room?



STUVA
loft bed combo with
3 drawers/2 doors
\$649

The STUVA loft bed combines a desk, a wardrobe and an integrated shelf unit into a complete solution. Fasten it to the wall for a secure fit and it will help you bring order to chaos, or at least make room for some more chaos.

STUVA loft bed combo with 3 drawers/2 doors \$649. Solid birch, Acrylic paint. RA. W113xL197xH193cm. Minimum ceiling height required: 94 1/2" (240cm). Mattress and bedlinens sold separately. White 490.235.33
Shop online at [IKEA.ca](https://www.ikea.com)

Sleeping

The day starts and ends here, among a mess of soft covers and plush pillows. And with a bit of dreaming, it can be elevated beyond a simple place to snooze. It could feel like a hotel in a far-flung city. Or an enveloping space high up in the clouds. It could be a private island for one in a shared room. Or a stylish sanctuary that blends the personalities of two. Whatever mood you create, your bedroom will be a peaceful and personal place to spend way more than just eight hours.

01 HEMMA/REGOLIT pendant lamp \$11.99. Rice paper. RA. Cord length 4.7m, Ø45cm. Cord and shade sold separately. 101.758.10/701.034.10

02 IVAR cabinet \$99/ea. Solid pine. RA. W80xD30xH83cm. 400.337.63

03 New ÄNGSLILJA full (double)/queen duvet cover and 2 pillowcases \$49.99. 100% cotton. White 003.185.41

04 GJÖRA queen bed frame \$429. Solid birch. RA. Slatted bed base included, mattress and bedlinens sold separately. 691.299.96

05 New SJÖSLEV rug, flatwoven \$79.99. 97% jute, 3% wool. Designer: Paulin Machado. 4' 4" x 6' 5" (W133xL195cm) Off white/black 602.852.60

06 NORRÅKER stool \$39.99. Stained, clear lacquered solid birch. Designer: J Karlsson/N Karlsson. RA. W45xD29xH45cm. White birch 002.753.44

RA=REQUIRES ASSEMBLY



That getaway feeling at home

For many of us, being in a hotel room is the unmistakable cue that vacation has begun – a time to unplug and unwind without a to-do list in sight. But you don't have to wait for your next getaway to have that feeling. This is the staycation bedroom, a space so comfortable and plush it feels like a hotel far, far away. With cozy spaces for watching TV, eating, reading and talking, the only thing missing is room service.



01 VARDAGEN teacup and saucer \$3.49.
Stoneware. Designer: Preutz/Wihlborg/Braasch/Karlsson. 26cl. 802.883.14

02 STOCKSUND armchair \$549/ea.
75% cotton, 25% polyester. Stained solid beech. RA. W92xD95xH89cm. Nohaga dark grey/black/wood 890.335.54

03 LOTS mirror \$9.99/4 pack.
Mirror glass L30xW30cm. 391.517.00

04 SANELA curtains, 1 pair \$79.99/2 pack.
100% cotton velvet. W140xL250cm/per panel. Grey 802.301.96

05 OPPLAND queen bed frame \$529.
Stained, clear lacquered ash veneer. Removeable, washable headboard cover: Polyester and nylon. RA. Slatted bed base included, mattress and bedlinens sold separately. Brown/grey 291.033.09

06 GÄSPA full (double)/queen duvet cover and 2 pillowcases \$59.99. 100% cotton satin. 310 thread count. Dark grey 001.513.29

RA=REQUIRES ASSEMBLY

Delivery service. We can bring your purchases to your home or business. Prices from \$79. See page 309.



01

02

04

03

06

05 BOLLTISTEL
full (double) queen duvet
cover and 2 pillowcases
\$59⁹⁹

The dream bedroom recipe

When your bedroom is a soothing and sublime retreat, you have more energy for the important things in life – friends, family and you. This is your guide to creating it with the right mood lighting, textiles and above all – comfort. These three steps can help transform the bedroom into the calm refuge of your dreams.

01 VIVAN curtains, 1 pair \$14.99. 70% polyester, 30% cotton. W145xL250cm/per panel. 602.975.69

02 HEKTAR wall/clamp spotlight \$19.99/ea. Steel and aluminum. Designer: Ola Wihlborg. Ø11cm. Shade H15cm. 502.165.40

03 TRYSIL queen bed frame \$199. Foil finish and powder-coated steel. RA. Slatted bed base included, mattress and bedlinens sold separately. Dark brown 490.078.11

04 ALÄNG table lamp \$24.99. Nickel plated steel, polystyrene and paper. Ø30xH61-80cm. RA. White 500.291.62

05 BOLLTISTEL full (double)/queen duvet cover and 2 pillowcases \$59.99. 55% lyocell and 45% cotton satin. 207 thread count. Designer: Andreja Špegel. 702.865.32

06 TRYSIL nightstand \$59.99. Foil finish and powder-coated steel. RA. W45xD40xH53cm. Dark brown 602.360.24

07 New VIDGA single track rail \$13. Aluminum and plastic. Designer: David Wahl. RA. L140cm. 702.991.53

RA=REQUIRES ASSEMBLY

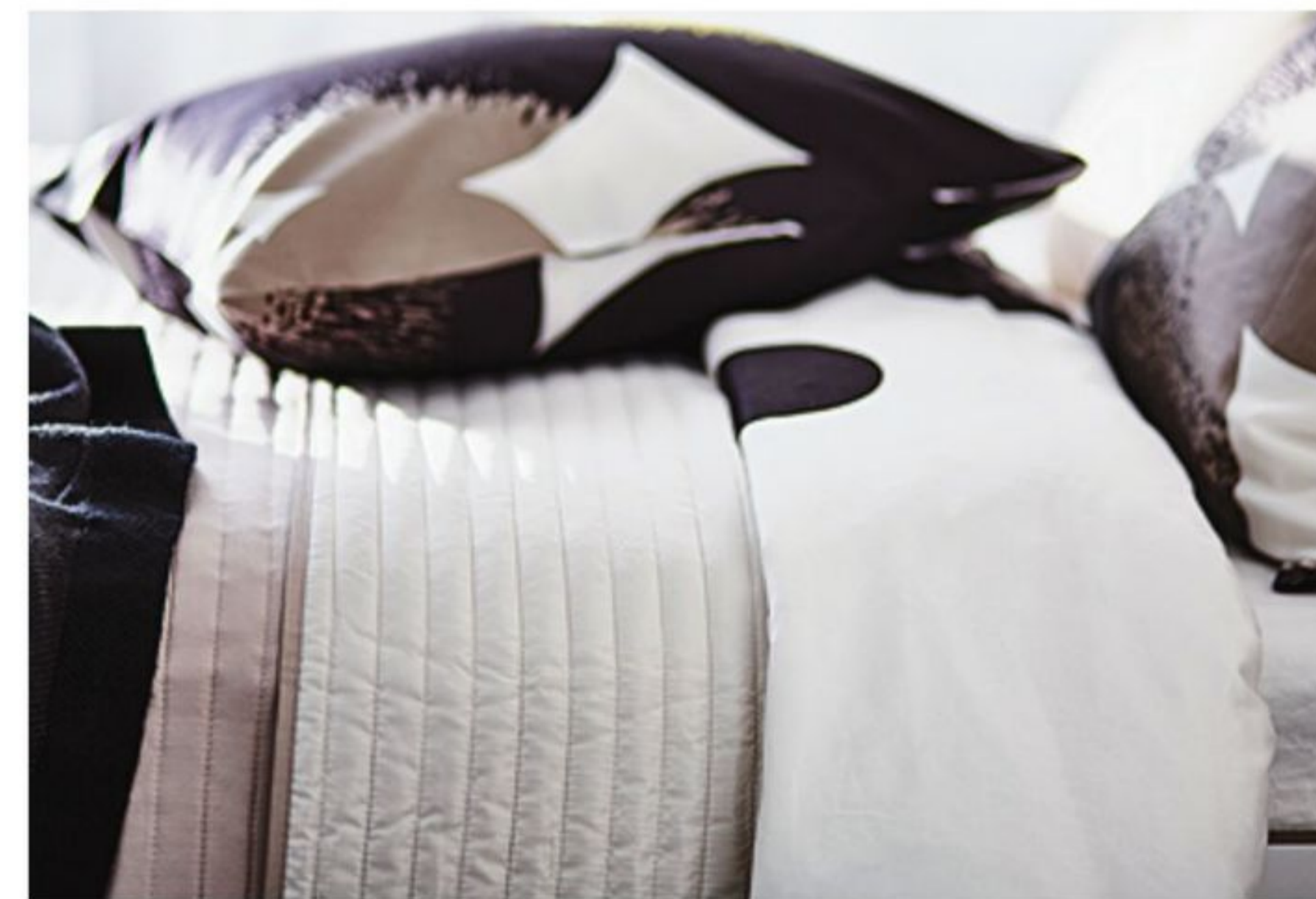

Comfort

Finding the right combination of mattresses, pillows and bedding is the foundation for comfortable and restful sleep. Mattresses and pillows come in a range of firmness and materials to suit every body. Testing out both soft and firm styles will help you determine what's most comfortable. For duvets, the key is warmth level. Consider the climate you live in and whether you like it cool or warm when you sleep. There's a duvet with the right filling and warmth rating to suit your needs.

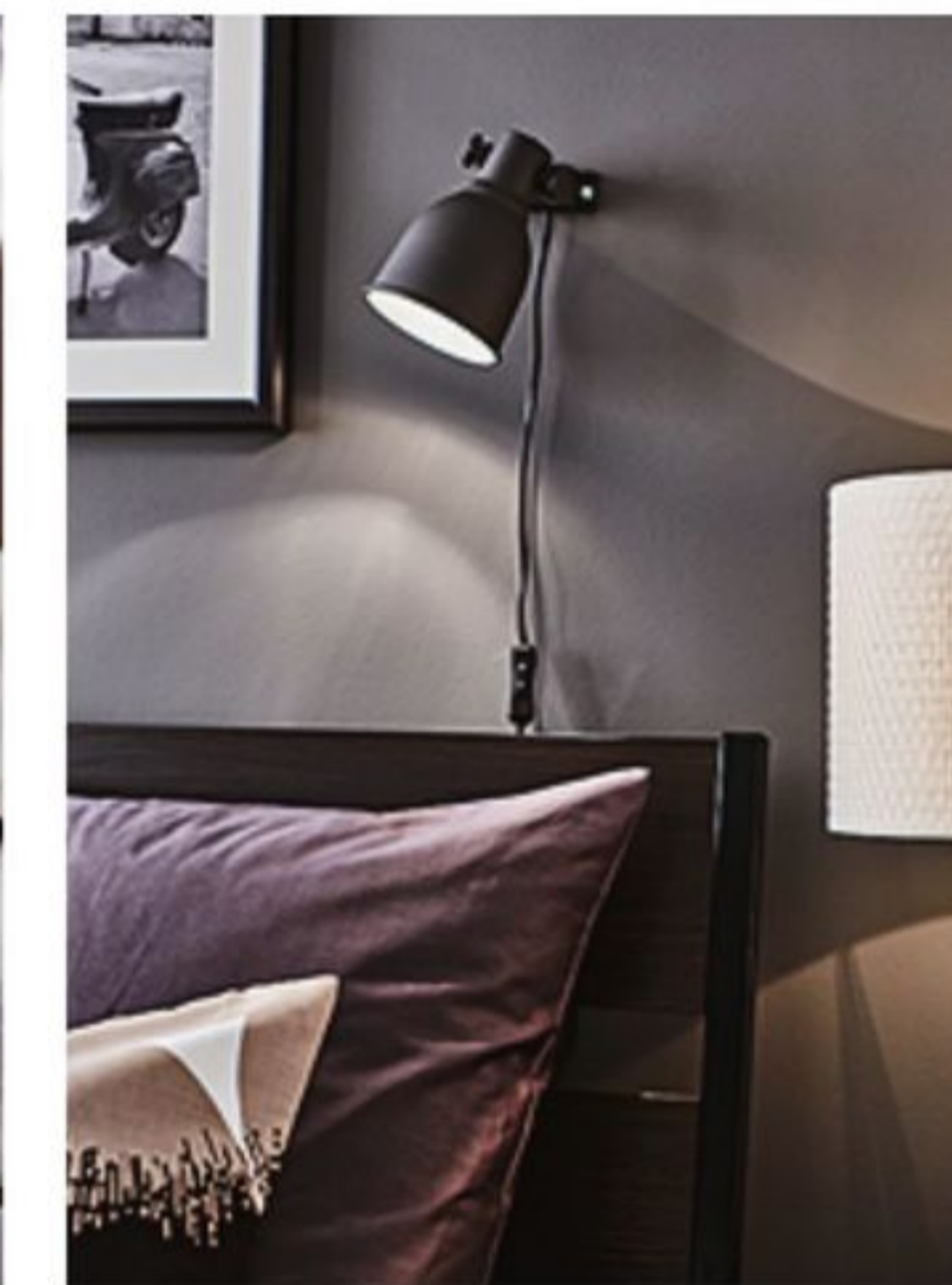

Lighting

The bedroom is a multifunctional room that needs the right lighting to match. Ceiling lamps offer ideal general lighting, while a diverse mix of table and floor lamps help improve the cozy mood. Bedside lighting does this job too, as well as offering functional light that can be directed right where you need it.



Textiles

Soft materials on your bed and windows help create that dreamy bedroom vibe. The bedding part is simple – something soft and stylish will do. Curtains, on the other hand, do a few big jobs – adjusting light and privacy, as well as insulating the room. A great solution that gives you control over all three is combining a blackout blind with a pair of sheer curtains.



A bedroom in disguise

When your bedroom is the living room, carving out a personal and quiet space of your own becomes even more important. This heart of the home is made for everyone, but cleverly hides away the functionality of a bedroom for one. The cabinet is a wardrobe, the screen a changing room, and the couch a comfy bed for sleeping in – as long as you don't mind some company in the morning.

Delivery service. We can bring your purchases to your home or business. Prices from \$79. See page 309.



01 HEKTAR floor lamp \$69.99.
Was \$79.99. Powder-coated steel and plastic. Designer: Ola Wihlborg. RA. H181cm. Dark grey 702.165.44

02 IVAR side unit \$22/ea. Solid pine. RA. W50xH179cm. 637.567.09
Fabric sold separately.

03 KRAGSTA nesting tables, set of 2 \$99. Sizes: 1 pc Ø49, H51cm and 1 pc Ø35, H45cm. Painted finish. Designer: Carina Bengs. 002.998.25

04 New VALLENTUNA 3 seat sofa with bed \$1335. 55% cotton, 25% polyester, 12% viscose/rayon, 8% linen. Designer: Fredriksson/L Löwenhielm/Hilland. RA. Bed size 80x200cm. Hillared green 091.501.32

05 ALEX desk \$169. Steel/particleboard. Designer: Johanna Asshoff. RA. W131xL60xH76cm. Grey 902.607.10

06 EMMIE RUTA full(double)/queen duvet cover and 2 pillowcases \$49.99. 100% yarn dyed cotton.152 thread count. Pink/white 802.167.08

07 JANSJÖ LED floor lamp \$29.99. Built-in LED light source. RA. H166cm. Black 902.142.14

08 HEMNES wardrobe with 2 sliding doors \$369. Stained, clear lacquered solid pine. Designer: Carina Bengs. RA. W120xD59xH197cm. Yellow 103.213.26

09 MALM 3-drawer chest \$99. Painted finish. RA. W80xD48xH78cm. Turquoise 203.235.46

RA=REQUIRES ASSEMBLY

Stay in bed a little bit longer

Preparation doesn't have to be a dirty word – especially when it buys you more time in bed. Just a few simple steps like hanging up tomorrow's outfit and laying out the little things like watches, wallets and devices means a little extra shut-eye. Go ahead and hit snooze. Twice.



01 NORDMÄRKE triple pad for wireless charging \$79.99. Plastic and synthetic rubber. Designer: David Wahl. L31cm. 103.083.15
VITAHULT wireless charging cover \$29.99. Made to work with Qi-enabled devices. Polycarbonate plastic. White 703.183.83

02 NORDRANA basket, set of 4 \$19.99. 100% polypropylene. Sizes (LxWxH): 2 pcs 9x9x11cm, 1 pc 19x19x15cm and 1 pc 29x9x11cm. Designer: J Jelinek/H Dalrot. Grey 102.883.03

03 ARKELSTORP desk \$229. Stained, clear lacquered solid pine. Designer: Ebba Strandmark. RA. W140xD70xH74cm. Black 602.610.37

04 HEMNES 3-drawer chest \$169. Stained, clear lacquered solid pine. Designer: K Hagberg/M Hagberg. RA. W108xD50xH95cm. Black-brown 603.186.04

05 STOCKSUND bench \$269. 75% cotton, 25% polyester. Stained solid beech. RA. W144xD49xH47cm. Nolhaga dark grey/black/wood 590.336.21

06 UNDREDAL queen bed frame \$449. Painted finish. RA. Slatted bed base, mattress and bedlinens sold separately. Black 990.601.13

RA=REQUIRES ASSEMBLY



06 UNDREDAL queen bed frame \$449

05 STOCKSUND bench \$269

Harmonizing your styles

Moving in together is an exciting step in a relationship. But finding a way to unify your two different aesthetics – and furniture – is a challenge many have faced before you. The key to moving-in bliss? Textiles. Picking a two- to three-colour scheme, and applying it to bed linens, rugs and curtains ties together your two personal styles – without losing either.

01 TIGERÖGA fabric \$6.99/m. 100% cotton. Designer: Inga Leo. W150cm. 303.081.02

02 MALM queen pull-up storage bed \$449. Was \$499. Practical storage space revealed by lifting the slatted base. Painted finish. RA. Slatted bed base included, mattress and bedlinens sold separately. Black-brown 402.498.81 Also available in white.

03 PENNINGBLAD queen/king bedspread and 2 cushion covers \$129. Front: 100% cotton. Back/filling: 100% polyester. Bed spread W260xL280cm. Cushion covers L40xW65cm. 202.296.38

04 RANARP work lamp \$39.99. Powder coated steel. RA. H42cm. Black 103.313.92

05 HEMNES nightstand \$69.99. Stained, clear lacquered solid pine. Designer: Nike Karlsson. RA. W46xD35xH70cm. 901.212.34

06 KATTRUP rug, flatwoven \$299. 100% wool. 5'7" x 7'10" (W170xL240cm) Rust 303.340.35

RA=REQUIRES ASSEMBLY



NEW
LOWER
PRICE

02 MALM
Queen pull-up storage bed
Was \$499

\$449

03 PENNINGBLAD
queen/king bedspread
and 2 cushion covers

\$129

Private sleep zones for all

When you live with roommates, it can be hard to find those “me-time” moments. But creating a small island with a population of one can really help. Bookcases and clothing racks affordably divide up the bedroom space and help to dampen noise, making sure alone time is truly your own.



02 **KALLAX** shelving unit with doors \$139.99/ea



05 **New FYRESDAL** twin daybed \$269

01 **RIGGA** clothes rack \$18.99/ea. Powder-coated steel and plastic. RA. W111×D51×H126/175cm. White 502.316.30

02 **KALLAX** shelving unit with doors \$139.99/ea. Foil, painted fibreboard, and particleboard. RA. W77×D39×H147cm. 491.836.87
TJENA box with lid \$7.99/ea. W32×D35×H32cm. RA. White 202.636.32

03 **SVIRVEL** floor lamp with 2 shades \$49.99. Polypropylene plastic and steel. RA. H159cm. 202.897.26

04 **MOSSFLOX** full(double)/queen duvet cover and pillowcases \$29.99. 100% cotton. 144 thread count. Multicolour 803.089.63

05 **New FYRESDAL** twin daybed \$269. Fits two mattresses when open. Powder coated steel. RA. Slatted bed base included, mattresses and bedlinens sold separately. Black 403.188.84

06 **FJELLSE** twin bed frame \$69.99. Untreated solid pine. Shown here painted light grey. RA. Slatted bed base included, mattress and bedlinens sold separately. 590.098.24

RA=REQUIRES ASSEMBLY





01 RÖDVED
full (double)/queen duvet
cover and 2 pillowcases
\$16⁹⁹

02

03

04 MINNEN
extendable bed frame
with slatted bed base
\$149

05

The “monsters under the bed” bed

The little ones always shuffle sleepily into mom and dad’s room at night. It’s the coziest and safest place at home – and the perfect refuge when there are monsters under the bed. But it doesn’t have to mean sacrificing comfort because the bed is crowded. An extra one is the perfect place for a child dad to sleep soundly.

01 RÖDVED full (double)/queen duvet cover and 2 pillowcases \$16.99. 52% polyester, 48% cotton. Designer: Linda Svensson Edevint. White/green 703.043.19

02 New KOPARDAL queen bed frame \$199. Slatted bed base, bedlinens and mattress sold separately. Grey 691.576.68

03 SELJE nightstand \$49.99. Powder-coated steel. Designer: Monika Mulder. RA. W46×D37×H55.5cm. White 802.270.14

04 MINNEN ext bed frame with slatted bed base \$149. Mattress and bedlinens are sold separately. Solid pine and powder-coated steel. RA. W102×L125/195×H92cm. Mattress size 97×196cm. White 591.246.21

05 SPÖKA LED night light \$18.99. Polypropylene plastic and silicon rubber. Designer: Bodrul Khaliq. H7cm. White/red 901.509.95

RA=REQUIRES ASSEMBLY

Snoozing on a cloud

Our fast-paced world puts pressure on kids that can be hard for them to manage. But a good night's sleep is like hitting the reset button. A sleeping cocoon creates the perfect conditions for them to rest peacefully and get back to their most important job – just being a kid.

01 New HIMMELSK bed canopy \$14.99/ea.
100% polyester. Designer: Susana Rodriguez Fernandez. RA. 403.196.28

02 BUSUNGE extendable bed \$249.
Slatted bed base included, mattress and bedlinens sold separately. Painted and foil finish. Designer: Carl Öjerstam. RA. W107×L128–198×H100cm. Mattress size 97×190cm. 903.057.04

03 New DRÖMSYN wall lamp \$12.99/ea.
100% polypropylene. Designer: Sarah Fager. RA. W31×D8×H21cm. 303.303.58

04 SCHOTTIS pleated blind \$3.99/ea.
100% polyester. RA. W90×L190cm. 202.422.82

05 BUSUNGE wardrobe \$149. Foil and painted finish. Designer: Carl Öjerstam. RA. W80×D52×H139cm. 203.057.07

06 MAMMUT stool \$8.99. Suitable for indoor or outdoor use. Polypropylene. RA. H30cm. White 901.766.41

07 New HIMMELSK rug \$49.99.
100% polypropylene. Designer: Susana Rodriguez Fernandez. 5' 3" × 4' 4" (W133×L160cm). 303.197.23

RA=REQUIRES ASSEMBLY



No little sisters allowed

Sometimes adults need their own private space to recharge and relax, and so do kids. Especially when they're sharing a room. The good news is that the right furniture can affordably divide up the room, letting them create their own unique space – without compromising. The only bad news? We can't do anything about sibling rivalry.



Eric
Children's IKEA Shopkeeper, Canada

Two children can comfortably share the same room, as long as you first take care of the sleeping area. Sleep is really important for a child's healthy growth, so they need their own quiet and cozy spaces at bedtime. After that, the room is simple to organize safely when you look at it from the height that the children see.



01

02 **FLAXA**
twin bed frame with headboard

\$169

03



04 **CHARMTROLL**
bed canopy
\$14.99

07

05

06

01 JULES junior chair \$39.99.
Molded plywood, acrylic paint, powder-coated steel. RA. Seat W35×D32×H38-50cm. White 198.850.43

02 FLAXA twin bed frame with headboard \$169. Painted and foil finish. Slatted bed base included, mattress and bedlinens are sold separately. RA. 790.314.66

03 BOLLKÄR soft toy \$12.99. Recommended for children 18 months and older. 100% polyester. Designer: Malin Unnborn. Ø33cm. 702.735.15

04 CHARMTROLL bed canopy \$14.99. 100% polyester. Designer: Silke Leffler. W80×L150×D80cm. 802.902.08

05 GULLIVER crib \$159. Tinted, clear lacquered solid beech and beech veneer. Mattress and bedlinens are sold separately. RA. W75×L136×H83cm. Mattress size 70×132cm. 802.485.25

06 New DRÖMLAND crib duvet cover/pillowcase \$14.99. 50% cotton, 50% lyocell. Designer: Lisel Garsveden. Duvet cover W110×L125cm. Pillowcase W35×L55cm. Multicolour 303.195.63

07 TROFAST storage combination \$61. Foil finish and plastic. RA. W46×D30×H94cm. 191.670.28

RA=REQUIRES ASSEMBLY

Favourable lighting



New
ÄNGLAND
table lamp
\$24⁹⁹

The decorative light from our new lamp ÄNGLAND spreads around the room to create a soft and cozy atmosphere. Add to that a classic design that will make your home look its best – even when the sun is out.

New ÄNGLAND table lamp \$24.99.
Powder-coated steel and 100% polyester.
RA. H57cm. Ø30cm. 502.912.85
Shop online at [IKEA.ca](https://www.ikea.ca)

Looking for beauty? Head for the door!

**NEW
LOWER
PRICE**
GARNES
over-the-door mirror
Was \$44.99-
\$39⁹⁹



Out of wall space? The GARNES mirror casts its reflections hanging on your door. It is suitable for use in most rooms, including bathrooms.

GARNES over-the-door mirror \$39.99.
Was \$44.99- Powder-coated steel and mirror glass. Designer: Ola Wihlborg. RA.
W38xH155cm. 002.851.83
Shop online at [IKEA.ca](https://www.ikea.ca)

Bathroom

We demand a lot from our bathrooms, a smaller space that has an important job to do. This traffic-heavy room is where we retreat for a few moments of self-care each day, whether it's some feel-good grooming, a regenerative bath or simply brushing your teeth.

01 **New GODMORGON**
wall cabinet with 1 door

\$79/ea

02

03

04

05 **GODMORGON/BRÄVIKEN**
sink cabinet with 2 drawers

\$279

(faucet sold separately)

06

07 **MÄSTERBY**
step stool

\$39⁹⁹

01 New GODMORGON wall cabinet with 1 door \$79/ea. Foil finish and tempered glass. RA. W40×D32×H58cm. White 003.304.30

02 GODMORGON mirror \$29.99. Mirror glass W60×H96cm. 301.491.32

03 GRUNDTAL towel holder with 4 bars \$24.99. Stainless steel. RA. W46×H25cm. 600.478.96

04 DALSKÄR bathroom faucet \$89.99. Chrome-plated brass. H18cm. 202.812.97

05 GODMORGON/BRÄVIKEN sink cabinet with 2 drawers \$279. Foil finish and crushed marble. RA. W62×D49×H68cm. White 490.234.39
Faucet sold separately.

06 ALGOT laundry bag with frame \$19.99. Powder-coated steel and 100% polyester. Designer: Francis Cayouette. RA. W30×D40×H70cm. 56L. 402.332.91

07 MÄSTERBY step stool \$39.99. Recycled PP plastic. W43×D40×H50cm. Light blue 103.320.75

RA=REQUIRES ASSEMBLY

A rental refresh

The rental bathroom often feels like a constant compromise – with tired porcelain sinks and tiles from last century. But personal add-ons can take it from dated to darling. Wall cabinets and wheeled trolleys offer storage to fit your space. And DIY touches make for a bathroom upgrade with your own signature style.

01 BLÅVIK LED wall lamp \$15.99. Plastic and rubber. Built in LED light source. 2 AA batteries required, sold separately. White 603.122.92

02 LEJEN cabinet \$19.99/ea. ABS plastic. Designer: David Wahl. RA. W20×D23×H62cm. 602.794.62

03 VÄSTERÖN stool, indoor/outdoor \$19.99. Powder-coated steel and plastic. Designer: I Bermudez/F Cayouette. RA. L36×W36×H44cm. 503.079.55

04 STUGVIK basket with suction cup \$9.99/ea. Plastic and synthetic rubber. W28×D17×H19cm. 502.493.81

05 GRUNDTAL trolley \$49.99. Stainless steel and plastic. Designer: K Hagberg/M Hagberg. RA. W48×D24×H77cm. 601.714.33

06 HÄREN bath towel \$3.99/ea. 100% cotton. W70×L140cm. 501.635.46

RA=REQUIRES ASSEMBLY



Stand-alone storage and baskets that are attached with suction cups create a personalized space – without the drill.



01

A colourful, DIY add-on can make your towels a bit more personal.

02 LEJEN cabinet, W20×D23×H62cm \$19.99/ea

Fabric can be used to create a unique pattern that elevates a stool.

03 VÄSTERÖN stool, in/outdoor \$19.99

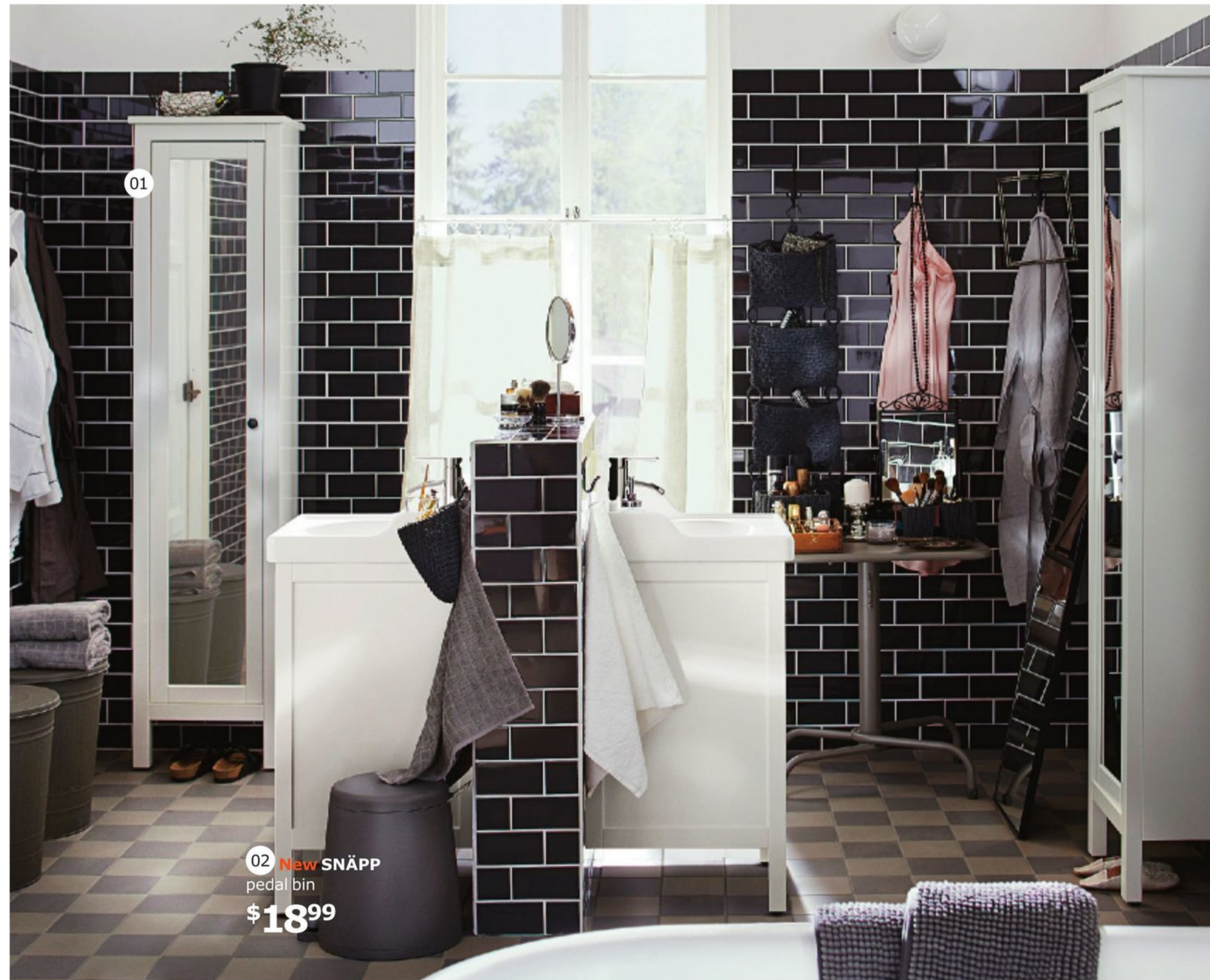

01

02 **New SNÄPP**
pedal bin
\$18.99

An oasis for me - and you

In an ideal world, the bathroom would be a private retreat – a place to spend hours indulging in personal primping you don't want anyone else to see (we're looking at you, bushy eyebrows). The reality? Most of us have to share – but not if you get creative. Dividing the space to create a secluded section just for you turns a shared bathroom into a "me" bathroom. Is it vain? Maybe. But in this room, we think it's ok to be a little selfish.



03

05

04

06 **HEMNES/RÄTTVIKEN**
sink cabinet with 2 drawers
\$299
(faucet sold separately)

01 HEMNES high cabinet with mirror door \$249. Painted finish and mirror glass. Designer: T Christensen/K Legaard. RA. W49×D31×H200cm. White 702.176.85

02 New SNÄPP pedal bin \$18.99. Polypropylene plastic. Designer: Marcus Arvonen. H40, Ø40cm. 12L. 102.454.22

03 TRENSUM mirror \$9.99. Mirror glass and stainless steel. Ø17, H33cm. 245.244.85

04 ÄFJÄRDEN bath towel \$11.99/ea. 100% cotton. W70×L140cm. Grey 102.957.99

05 DALSKÄR bathroom faucet \$89.99. Chrome-plated brass. Designer: Magnus Elebäck. H18cm. 202.812.97

06 HEMNES/RÄTTVIKEN sink cabinet with 2 drawers \$299. Painted finish and ceramics. RA. W63×D49×H89cm. White 599.060.72
Faucet sold separately

RA=REQUIRES ASSEMBLY

Bathtime gets Zen

The bathroom is the ultimate private space – to energize, relax, heal and pamper. But it's not just parents who need this quiet time – it's the little ones too. The warmth of wood and natural materials, as well as a subtle colour scheme creates a Zen-like atmosphere that's made for bathtime. But no one here acts like a monk. Monks don't have rubber ducks.

01 SÖDERSVIK LED wall lamp \$89.99.
Built in LED light source. Polycarbonate plastic and aluminum. Designer: Lycke von Schantz. L70cm. 702.480.74

02 GODMORGON mirror cabinet with 2 doors \$349.
Foil finish, tempered glass and mirrored glass. RA. W100×D14×H96cm. 603.043.53

03 DALSKÄR bathroom faucet \$89.99/ea.
Chrome-plated brass. Designer: Magnus Elebäck. H18cm. 202.812.97

04 GODMORGON/BRÅVIKEN sink cabinet with 2 drawers \$649. High-gloss foil finish and crushed marble. RA. W102×D49×H68cm. 299.035.22 Faucets sold separately.

05 MOLGER bench \$59.99. Clear lacquered solid birch. Designer: Richard Clack. RA. W79×D37×H50cm. Birch 402.414.51

06 TOFTBO bathroom mat \$12.99/ea.
100% polyester microfibre. W60×L90cm. White 702.034.00

RA=REQUIRES ASSEMBLY

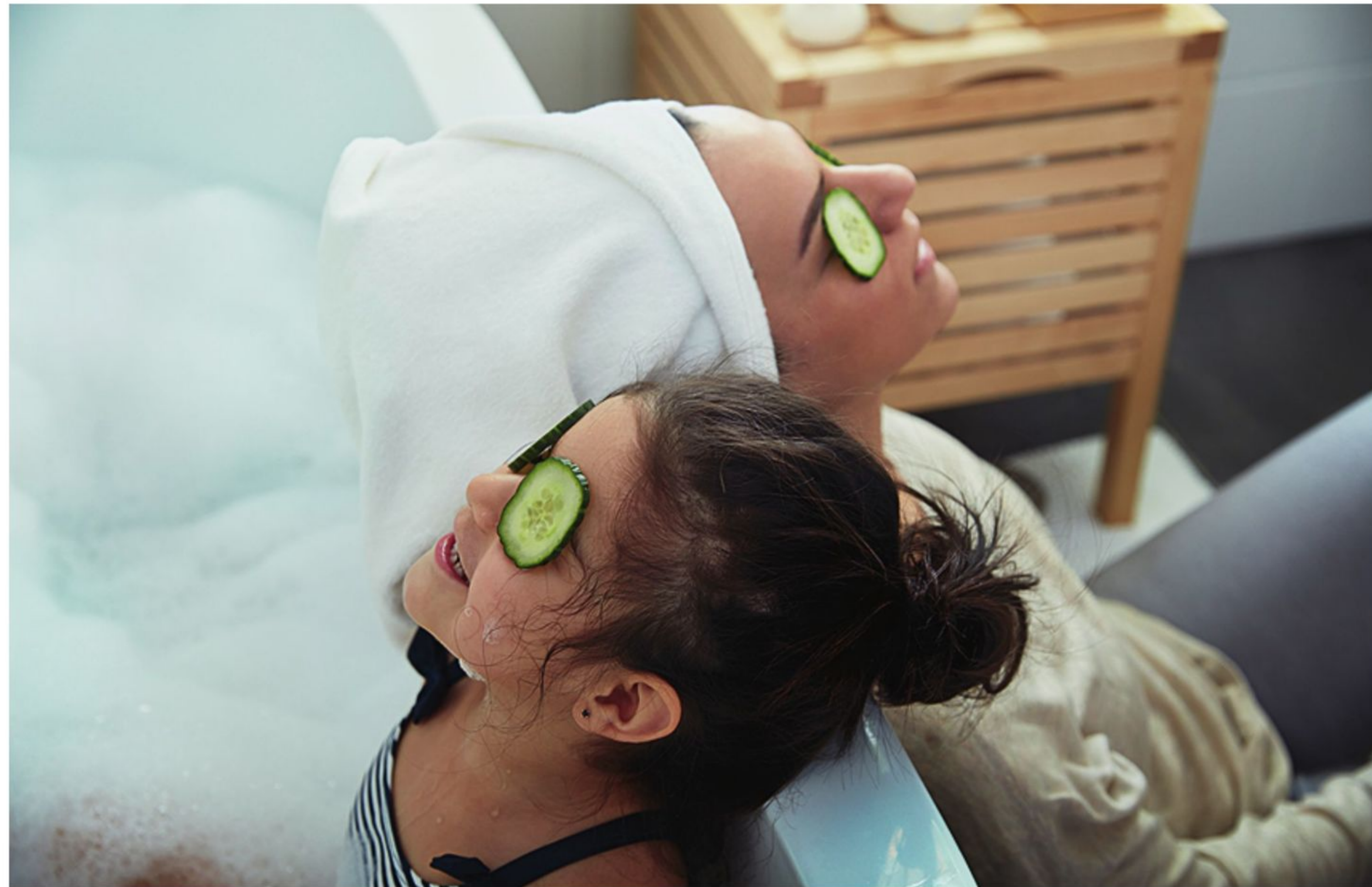



A better conscience bathroom

Most of us are more aware than ever about the importance of reducing our footprint, particularly in the bathroom. But we also don't want to sacrifice those cherished moments of self-care. Well, you don't have to. A few simple acts – like using LED light bulbs or sorting recyclable waste – can help minimize your mark, and allow you to enjoy a hot shower with a good conscience.



Kirsten
Sustainability Specialist, UK

The bathroom is where a lot of our recyclable waste – like plastic bottles and cardboard – tends to pile up and get thrown out with the regular trash. But a simple solution, like this storage bench with a couple of bins, makes it pretty effortless to recycle those items.

01 SILVERÅN storage bench \$69.99.
Stained, clear lacquered solid pine. RA. W54.4×D35×H46.6cm. Light brown 902.679.95

02 VARIERA recycling bin \$8.99.
Recycled PP plastic. Designer: D Wahl/L von Schantz. RA.11L. 402.461.04 Complete with a **VARIERA lid \$3.** 302.046.18

03 HYLIS shelving unit \$14.99.
Can be used indoor/outdoor. Galvanized steel. RA. W60×D27×H140cm. 002.785.78

04 VITEMÖLLA wall lamp \$24.99.
Steel, plastic and glass. Designer: P Amsell/B Berlin. H28cm. 102.387.61

05 GUNNERN mirror cabinet with 1 door \$49.99. Powder-coated steel and mirror glass. Designer: T Christensen/K Legaard. RA. W31×D12.4×H62cm. White 102.620.96

06 GRANSKÄR bathroom faucet \$99.
Chrome-plated brass. RA. H16cm. 502.030.95

07 SILVERÅN/HAMNVIKEN sink cabinet with 2 doors \$229. Stained, clear lacquered solid pine and ceramic. RA. W63×D45×H90.5cm. Light brown 690.203.88 Faucet sold separately.

RA=REQUIRES ASSEMBLY



More space for pampering

When a small, shared space stands in the way of getting a dream bathroom, it's time to think outside the box – literally. With a bit of imagination, you can extend the bathroom beyond its walls to create an indulgent and roomy getting-ready space for all. Shared stations for hair and makeup give it a dressing room feel that's all about pampering with pals.

01 GRUA mirror \$19.99. Mirror glass and powder-coated steel. Designer: Chenyi Ke. W45×H55cm. 102.920.22

02 ENSEN bathroom faucet \$69.99. Chrome-plated brass. Designer: Niels Gammelgaard. H12cm. 202.813.82

03 LILLÅNGEN sink cabinet with 1 door \$119. Particleboard, foil, ceramic sink. RA. W40×D41×H92cm. White 491.553.83
Faucet sold separately.

04 KARMSUND table mirror \$14.99. Galvanized steel, polyester powder coating. W27×H43cm. Black 002.949.79

05 VITTSJÖ laptop table \$39.99/ea. Powder-coated steel, tempered glass and foil finish. Designer: Johan Kroon. RA. W100×D36×H74cm. 802.213.52

06 NORDRANA hanging storage \$24.99. Was \$29.99. 100% polypropylene. Designer: J Jelinek/H Dalrot. W30×H100cm. 602.883.05

07 LILLJORM mirror with integrated lighting \$49.99. Plastic and glass. Designer: Henrik Preutz. Ø55cm. Light source is sold separately. IKEA recommends four LEDARE LED bulbs E12 400 lumen chandelier opal white. 402.837.33

08 RÅSKOG stool \$29.99/ea. Powder-coated steel. Designer: Nike Karlsson. RA. W44×D44×H45cm. 803.083.93

09 LENNART drawer unit \$14.99. Galvanized steel, polyester powder coating. W30×D34×H56cm. 303.261.77

RA=REQUIRES ASSEMBLY



NEW
LOWER
PRICE

06 NORDRANA
hanging storage
Was 29.99

\$24⁹⁹

07 LILLJORM
mirror with integrated lighting
\$49⁹⁹

04

02

03

05 VITTSJÖ
laptop table

\$39⁹⁹/ea

A magnetic wall strip can hold hair clips and bobby pins that are all too easy to lose.

09

08 RÅSKOG
stool
\$29⁹⁹/ea

Inspired by the sea, designed for landlubbers



The feeling of slipping into a fresh set of cotton sheets can make anyone want to go to bed early. RINGKRAGE lures you in with a pattern inspired by seashells and the smooth, round shapes of the shore.

RINGKRAGE full(double)/queen duvet cover and pillowcases \$29.99. Was \$39.99. 100% cotton. 144 thread count. Designer: Linda Svensson Edevint. 203.042.89
Twin \$24.99. Was \$29.99. 803.042.91
King \$39.99. Was \$49.99. 003.042.90

Are you ready to move to the next level?



PÅHL is a desk that will grow on you. It is easily adjusted to three different heights by using the knobs on the legs, and thanks to the sturdy construction it will take to all your new toys and challenges with ease.

New PÅHL desk \$89. Acrylic paint and powder-coated steel. Designer: S Fager/J Jelinek. RA. W96xD58xH59/66/72cm. 391.289.41
Shop online at [IKEA.ca](https://www.ikea.com)

RA=REQUIRES ASSEMBLY

What home is for a refugee without one

▼ Dive deeper into our features by downloading the IKEA Catalogue app.

Outside each plastic-panelled shelter, you see pairs of shoes. Many are muddy and dusty, evidence of the long journey taken to get here. They sit lined up outside door after door, a glimpse of the people within – parents, children, aunts and infants, who fled their homes in fear. Taking off your shoes at the door is a familiar custom, one many of us share. And here in a refugee camp, it demonstrates something powerful – a deep respect for the idea of home, however tenuous or temporary.



Above | Cousin Ibrahim*, 17, walks through the door of the family's Better Shelter.

For many refugees fleeing the Syrian civil war – a battle that has raged since 2011 – home is a flat-pack shelter. Initially funded by IKEA Foundation, and designed by Swedish social enterprise Better Shelter in cooperation with the UN Refugee Agency (UNHCR), they are one-room units that offer refugees in camps more dignity, safety and privacy than the tents that have been used since World War II. They have four walls, windows, room to stand straight up – and even a lock on the door.

“Moving into a shelter means this might be your home for while, and being able to close a door behind you – and lock it – means so much,” says Märta Terne, the Communications Manager at Better Shelter. “It’s something that a lot of us take for granted – those private moments and the private space you have for yourself.”

“Being able to be alone or with your family inside a controlled space is important, especially for people who have experienced such trauma,” she says. “They need to feel safe, be able to close that door, and just relax for a bit.”

Since 2015, UNHCR has ordered about 15,000 Better Shelters, which have been

deployed by the refugee agency in seven countries. But two of those countries – Greece and Iraq – particularly illustrate the ways in which Syrians have responded to the crisis, and how these shelters are housing refugees from just a few days up to many years.

“We consider this our house now”

Most Syrians have escaped to neighbouring countries – like Iraq, Lebanon and Jordan – where a shared culture, language and religion make the transition much easier. Thousands end up in refugee camps, like the ones in the relatively quiet northern Iraqi cities of Erbil and Sulaymaniyah, waiting for the war to end. They live in limbo, with little freedom to move around and no access to jobs or education. And while they wait, they do what any of us would – they make their Better Shelters feel more like home.

“The camps in Iraq are a bit more permanent,” Märta says. “People have had a chance to bring more personal items, and have spent more time decorating the shelter with textiles to make it more personal. They, in a sense, accept that this will be their home for a period of time, and choose to make it cozy.” >>

Left | Hasnea*, 4, climbs a lamppost in Kara Tepe with the help of her older sister.





Better Shelters are designed to house refugees who have fled armed conflict, persecution or natural disaster. They are built with refugees' unique needs in mind. Better Shelters:



- last 3 years, 6 times longer than a typical refugee tent
- are modular and can be adapted, moving the windows and doors wherever needed
- are illuminated by a solar-powered LED light that also charges mobile phones
- can be locked from the inside or out using a padlock
- offers families a living space of 17.5m².



A few hundred kilometres east of the Syrian border, there are thousands of Better Shelters erected in the two camps here. They are far better than fabric tents, especially when Iraqi winters turn cold. The floors are raised to provide insulation, while the hard plastic walls stop wind and provide privacy.

"Of course, we can't compare this housing with our real home back in Syria, but there is a huge difference compared to living in a tent," says Noveldin, a Syrian refugee living in the Kawergosk refugee camp in Erbil, who asked that his last name not be used. "We consider this our house now."

Outside many of these modular shelters – which can be assembled in just a few hours – you see people cleaning panels, hanging up laundry or tending to the flowerbeds and small fences they have put up to recreate something from home.

"All of these symbolic actions and items really make you feel more at home," Märta says. "These might be specific to certain families or cultures, but they're very essential. They take pride in their home, even if it's not one they chose."

Safety and security a lock can bring

An estimated 10 per cent of Syrian refugees have chosen a dramatically different path – one that has taken them on a perilous and sometimes deadly journey across the Aegean Sea to Europe. Many ended up in temporary accommodation facilities like Kara Tepe on the Greek island of Lesbos, a place where they can feel secure, and get access to services and protection.

"It is a humbling and awe-inspiring experience," says Boris Chesherkov, the UNHCR spokesperson on Lesbos. "It's emotionally taxing for all of us. When you see the level of desperation they felt to take this extremely dangerous journey, you understand that your role has meaning."

Since 2015, more than a million refugees have transited through Lesbos, an island that has shown tremendous goodwill, compassion and generosity. There are just 86,000 residents, who have welcomed refugees like Anouar* with open arms and open hearts.

A 40-year-old former taxi driver from

"Most refugees are not what you see reflected on TV. They're moms and dads taking their kids across the sea, the ocean and the desert on a very dangerous journey to have a better life."

Jonathan Spampinato, Communications Manager for IKEA Foundation.

Aleppo, Syria, Anouar fled the city of his birth – and the family home his father built – with his wife, nephew and five children. A rocket fell just blocks from their house, causing part of it to collapse. With Aleppo crumbling around them, they fled through Turkey and onto a smuggler's boat to Greece. They came with nothing but ID cards and some clothes, unable to salvage anything from their house – no photos, no keepsakes, no record of their lives before.

"When there are no loud sounds, no planes, no shooting, I can make my kids go to sleep," says Anouar's wife Amina*. "In Syria when the planes came, the kids woke up and cried and screamed. This was from the war. My kids can sleep here and relax more."

Refugees are called guests in these camps, a show of respect and support from the local Greek authorities, UNHCR and other organizations that facilitate a range of services. Three meals a day, hygiene items like soap and baby diapers, and a place to charge their



Left | Mother Amina*, 40, sits with her youngest daughter Hanna*, 10 months, on a bench in Kara Tepe.

Below | Daughter Hasnea*, 4, holds baby Hanna* in Kara Tepe.



mobile phones are all provided. But the Better Shelter is where they spend most of their time.

"Locking the door is excellent," Amina says. "This is something that makes us feel safe and secure. My kids will not just walk out or something. We care about the personal belongings we have and now we keep them without worry."

Even though they stay just a short time, they make an effort to carve out personal space for their family – likely the first safe space since their escape.

"They stay for a short time, but they instantly start making it their own home," Märta says. "They wash their clothes and hang them up outside or inside the shelter. They create a cozy corner with blankets. And you can see shoes outside every shelter because they want to keep it clean. Finding a home and a safe space, even though it's temporary, is very important."

This notion of what "home" is for a refugee and how it could be made better was a particularly powerful idea for IKEA Foundation, whose mission is to create better opportunities for children.

"There are currently about 60 million forcibly displaced people in the world, and of that about 50-60 per cent are children," says Jonathan Spampinato, communications manager for IKEA Foundation. "That's Canada. Imagine a country the size of Canada filled with children without a safe place to call home, living in a camp somewhere. It's probably the single greatest need that children have – a place to sleep and a place to live." ■

*Names have been changed for their safety.

IKEA FOUNDATION is the philanthropic arm of INGKA Foundation, the owner of the IKEA Group of companies. The IKEA Foundation aims to improve opportunities for children and youth in some of the world's poorest communities by focusing on four fundamental areas of a child's life: a place to call home; a healthy start in life; a quality education; and a sustainable family income. We are also helping these communities fight and cope with climate change. By working with strong strategic partners like **UNHCR** and **Better Shelter**, IKEA Foundation can use innovative approaches to achieve large-scale results for children."



Coming soon

IKEA PS 2017

The way we live today has never been more unpredictable. This creates a need for furniture that's super smart and mobile, like tables that double as stools, sofas that fold away, or stackable moving boxes that transform into a storage solution. IKEA PS 2017 is as free, fun and flexible as the lifestyles it serves – for homes in all kinds of spaces.



Chargeable and easy to bring wherever you go – this light is truly designed for flexibility.

New IKEA PS 2017 LED multi-use light.
Steel, Powder coating.
Designer: Matali Crasset.
H25cm. LED light source.
403.338.08

#IKEAcollections

Innovative materials and designs – our collections are all about offering you something unique! See what else we've got going on at IKEA.ca/collections

For details, please visit IKEA.ca/collections



Available
spring
2017

04 **New IKEA PS 2017**
valet stand

01 **New IKEA PS 2017**
coffee table, foldable

02 **New IKEA PS 2017**
side table on casters

03 **New IKEA PS 2017**
corner easy chair with 18 cushions

01 **New IKEA PS 2017 coffee table, foldable.** Powder coated steel. Designer: Jon Karlsson. RA. L55×W55×H50cm. 603.354.20 02 **New IKEA PS 2017 side table on casters.** Clear lacquered solid beech and powder coated steel. Designer: Thomas Sandell. RA. L69×W40×H80cm. 703.340.57 03 **New IKEA PS 2017 corner easy chair with 18 cushions.** Powder coated steel and 100% polyester. Designer: J Booy/K Booy. RA. W90/90×D74×H75cm. 191.702.20 04 **New IKEA PS 2017 valet stand.** Powder coated steel. Designer: Gustav Carlberg. RA. W71×D56×H142–172cm. 003.354.23

RA=REQUIRES ASSEMBLY

Coming soon

SÄLLSKAP collection

Limited edition

Inspired by traditional Swedish design, SÄLLSKAP celebrates the joys of being together. Focused on print patterns and dining pieces in solid materials, this limited edition collection does a fine job of creating an inviting space where there's room for everyone.



Traditional Swedish design made for modern life. The SÄLLSKAP chair comes with built-in storage.

New SÄLLSKAP chair with storage \$129. Stained, clear lacquered solid pine. Designer: Mikael Warnhammar. RA. W44xD47xH75cm. 703.389.70

#IKEAcollections

Limited editions and new style expressions – our collections are all about offering you a new and unexpected side of IKEA. See what else we've got going on at IKEA.ca/collections.

For details, please visit IKEA.ca/collections



Available
Autumn 2016 –
for a limited
time only

03 New SÄLLSKAP
lamp shade
\$15/ea

02 New SÄLLSKAP
pre-cut fabric, dotted
\$19.99

01 New SÄLLSKAP
sofa bench with storage
\$229

01 New SÄLLSKAP sofa bench with storage \$229. Designer: Mikael Warnhammar. RA. W120xD54xH76cm. 003.363.28 **02 New SÄLLSKAP pre-cut fabric, dotted \$19.99.** 100% cotton. Designer: Maria Vinka. W150xL300cm. 403.417.66 **03 New SÄLLSKAP lamp shade \$15/ea.** SEKOND cord set is sold separately. Powder coated steel. Designer: Maria Vinka. RA. Ø24, H20cm. 903.334.53

Products

These are the things that work together day after day, many quietly in the background, to make life easier at home. So you can enjoy the moments taking place all around you. A big part of that is how they are made – in ways that are fair to the people behind them, to the planet and to you, with a fair price. Here is a sampling of our range of products. Discover even more at IKEA.ca and in your local IKEA store.

- 172 Growing
- 174 Cookware
- 180 Kitchen islands and trolleys
- 182 Kitchen accessories
- 184 Waste sorting
- 186 Tableware
- 196 Dining tables and chairs
- 204 Work desks and chairs
- 210 Charging

- 212 Lighting – directed
- 214 Lighting – mood
- 216 Lighting – general
- 218 Sofas
- 222 Sofa beds
- 228 Armchairs
- 230 Coffee tables
- 232 Home textiles
- 238 Rugs

- 244 Decoration
- 250 Shelves and cabinets
- 254 TV media and storage
- 258 Wardrobes
- 268 Chests of drawers
- 270 Entrance
- 272 Boxes and baskets
- 276 Bathroom
- 292 Beds

- 288 Bed textiles
- 282 Mattresses, duvets, pillows
- 296 Children's furniture
- 302 Children play



New SALTRÖD
mirror with shelf
and hooks
802.970.02
\$64⁹⁹

New LIXHULT
cabinet, orange
903.286.68
\$30

New KATTRUP
rug, flatwoven
303.340.35
\$299

IKEA 365+
deep plate/bowl,
angled sides
902.797.00
\$4⁹⁹/ea

Left | The IKEA 365+ carafe is beautiful, functional, sustainable, long-lasting – and has a price that many can afford. In other words, the perfect IKEA product.

Why good design is democratic

Many people think that design is about the shape of things. But at IKEA, it's so much bigger. It's about making things better. Our vision is to "create a better everyday life for the many people." It's our 'why'. It's a big promise, and to make sure we put it into reality, we have a way of doing things that we call democratic design.

Now, this phrase is not something that we made up to make us look better as a company. It's not a label that we stick on whenever and wherever suitable. Democratic design influences every step of our process, from formulating ideas to our finished furniture, whether that's a sofa, a table, a cooking pot or a drinking glass. Democratic design helps us raise the bar for making better products for more people – better because they're developed with an understanding that people want things that work and make life easier (function), that are beautiful (form), demand value for money (quality), care about the planet (sustainability), and are affordable (low price).

At IKEA, that last dimension – low price – is absolutely key in order to create a bet-

ter everyday life for the many. We want as many people as possible to enjoy our products in their everyday lives. Why make things for the few if you can make things better that can be enjoyed by the many?

It's not easy, but IKEA has always been about doing things differently. You can see this in our roots and our history, which are closely linked to democratic design. After all, IKEA was founded in southern Sweden, a country where the values of democracy grew strong and spread wide during the 20th century. It was in this spirit and context that IKEA came of age and found its own vision.

Making beautiful things that are expensive is easy. The same goes for sturdy items that are hard to transport and impossible to clean. The challenge is to meet all five

dimensions: form, function, quality, sustainability, and low price. It's hard, but thanks to democratic design – and a little bit of stubbornness – it can be done. And it's how we make things better. ■

"It's not easy, but IKEA has always been about doing things differently. You can see this in our roots and our history, which are closely linked to democratic design."

IKEA 365+ carafe with stopper \$3.99. Was \$4.99. Heat resistant glass. Designer: Preutz/Wihlborg/Braasch/Karlsson. 1L. 902.797.19



Above | Democratic design in its most clear and simple form.



01 BITTERGURKA hanging planter
\$16⁹⁹/ea

02 SATSUMAS plant stand with 5 plant pots
\$59⁹⁹

04 SATSUMAS plant stand, H70cm
\$59⁹⁹

03 SATSUMAS plant stand, H78cm
\$39⁹⁹

05 TOMAT spray bottle
\$1⁹⁹

01 BITTERGURKA hanging planter \$16.99/ea. Powder-coated steel and bamboo. Designer: Carl Hagerling. Outside diameter 29cm. H37cm. 902.857.82 02-04 SATSUMAS plant stands. Powder-coated steel and bamboo. RA. 02 Plant stand with 5 plant pots \$59.99. Designer: Johanna Asshoff. W36xH125cm. 102.581.55 03 Plant stand \$39.99. Designer: Carl Hagerling. H78cm. 402.581.54 04 Plant stand \$59.99. Designer: Carl Hagerling. L84xW28xH70cm. 902.581.56 05 TOMAT spray bottle \$1.99. Polypropylene. Designer: Mina Karami. 35cl. 202.858.27

RA=REQUIRES ASSEMBLY

The freshest ingredients

Make it a short walk to the garden. You don't even need a big space or a green thumb... just a few smart solutions.



01 HINDÖ cabinet with shelving unit, in/outdoor
\$169

Ready for growing... inside or out. The powder-coated steel can get wet and be used outdoors.

01 HINDÖ shelving unit with cabinet, in/outdoor \$169. Powder-coated steel and galvanized steel. Designer: David Wahl. RA. W78xD37xH158cm. 490.484.54 02 INGEFÄRA plant pot with saucer \$6.99/ea. Red clay. Designer: Ann-Carin Wiktorsson. Max. diameter flowerpot 15cm. H20cm. 302.580.41

RA=REQUIRES ASSEMBLY

GRÄSLÖK plant pot
\$23⁹⁹



GRÄSLÖK plant pot \$23.99. Galvanized steel. Max. diameter flowerpot 21cm. L53xW35xH26cm. 302.580.36

SOCKER greenhouse \$24.99. Powder-coated steel and plastic. Designer: Sarah Fager. RA. W45xD22xH35cm. 701.866.03



SOCKER greenhouse
\$24⁹⁹

BITTERGURKA plant pot \$15.99. Powder-coated steel and bamboo. Designer: Maria Bergström. L32xW15xH15cm. 802.857.87



BITTERGURKA plant pot
\$15⁹⁹

How to be a gardener, without a garden. You can grow fresh herbs and veggies for cooking in the smallest of spaces – and make the most of your sunny windows.

IKEA PS 2002 watering can \$1.99. 100% polypropylene. Designer: Monika Mulder. 1.2L. 103.082.64 SÖTCITRON self-watering plant pot \$14.99. Earthenware. Designer: Maria Bergström. Max. diameter flowerpot 10.5cm. L29xW11xH14cm. 702.857.78



SÖTCITRON self-watering plant pot
\$14⁹⁹

Easier is delicious

Anything that saves time and effort in the kitchen is something to be savoured. Like cookware that makes preparing, cooking and cleaning easier and, consequently, more of a joy.



01-02 VARDAGEN series. Stainless molybdenum/vanadium-steel and plastic. Designer: P Amsell/B Berlin. **01 Chef's knife \$17.99.** Length of knife blade: 20 cm. 402.947.22 **02 Paring knife \$8.99.** Length of knife blade: 9 cm. 202.947.18 **03 APTITLIG butcher block \$14.99.** Was \$16.99. Bamboo. Designer: Jon Karlsson. L45xW36cm. 002.334.29

IKEA 365+
tea towel, 2 pack.
\$5.99



IKEA 365+ tea-towel \$5.99/2 pack. 100% cotton. Designer: Maria Vinka. W50xL70cm. 802.578.12

MIXTUR
oven/serving dish
\$9.99



MIXTUR oven/serving dish \$9.99. Oven-safe glass. Designer: Susan Pryke. L35xW25cm. 800.587.61



SMÅBIT
knife and peeler
\$7.99

SMÅBIT knife and peeler \$7.99. Child-friendly and recommended for ages from 8 years. Includes: Knife 9cm (tot. length 18cm) and peeler 11cm. Stainless steel and plastic. Designer: Tina Christensen. 402.864.06

FÖLJSAM
oven dish
\$4.99



FÖLJSAM oven dish \$4.99. Heat resistant glass. L24.5xW24.5cm. 503.112.69

SPEIELL
5-piece kitchen
utensil set
\$4.99



SPEIELL 5-piece kitchen utensil set \$4.99. Includes: Turner (33cm), spoon (33cm), soup ladle (28cm), pasta server (30cm) and cooking tongs (28cm). Plastic. 503.190.34

01 IKEA 365+ IHÄRDIG
spice jar, 4 pack.
\$7.99

Simply move the grinder top to whichever jar of spices your recipe calls for.



01-02 IKEA 365+ IHÄRDIG series. Glass and plastic.
01 Spice jar \$7.99/4 pack. Ø6.5, H8.5cm. 15cl. 201.528.70
02 Spice mill \$9.99. Designer: Magnus Lundström. H12.5cm. 101.528.75

New VARDAGEN
loose-base cake pan
\$14.99



Have your cake and get it out easily, too, with removable bases for baking two types of cakes.

New VARDAGEN cake pan \$14.99. Cake pan with two different bottoms. Capacity: 10 and 12 cup. Anodized aluminum. Designer: Preutz/Wihlborg/Braasch/Karlsson. 802.569.83

New VARDAGEN
bowl
\$7.99



JÄMFÖRLIG hand held whisk \$14.99. Plastic and stainless steel. Designer: Wiebke Braasch. L27cm. 102.336.69 **New VARDAGEN bowl \$7.99.** Glass. Designer: Preutz/Wihlborg/Braasch/Karlsson. Ø26cm. 702.892.48



IKEA 365+ wok
\$24⁹⁹

IKEA 365+ wok \$24.99. Stainless steel with Teflon® Platinum+ coating. Ø28cm. 902.070.96



STABIL splatter screen
\$8⁹⁹

Keeps your cooktop splatter-free and fits most frying pans up to 32cm in diameter.

STABIL splatter screen \$8.99. Stainless steel. Designer: Henrik Preutz. Ø33cm. 101.125.30 **OUMBÄRLIG frying pan \$24.99.** Stainless steel with Teflon® Platinum+ coating. Ø28cm. 502.920.96

Smart details like a stackable design, oven-proof lids with steam vents and easy-to-clean stainless steel make IKEA 365+ cookware simple and fun to use — from the cooktop to the table, to the dishwasher and back into the cabinet.

FREE 15 Year Warranty

IKEA 365+ pot with lid, 5L.
\$34⁹⁹

IKEA 365+ saucepan with lid, 2L.
\$24⁹⁹



OUMBÄRLIG stockpot with lid \$34.99. Stainless steel with aluminum core. 10L. 002.864.13 **LÄMPLIG trivet \$9.99.** Stainless steel. RA. L50xW28cm. 301.110.87

Stainless steel with aluminum core. Designer: Preutz/Wihlborg/Braasch/Karlsson. **Pot with lid \$34.99.** 5L. 102.567.50 **Saucepan with lid \$24.99.** 2L. 902.567.46

OUMBÄRLIG stockpot with lid
\$34⁹⁹



OUMBÄRLIG stockpot with lid \$34.99. Stainless steel with aluminum core. 10L. 002.864.13 **LÄMPLIG trivet \$9.99.** Stainless steel. RA. L50xW28cm. 301.110.87

RA=REQUIRES ASSEMBLY

ANNONS 5-piece cookware set
\$14⁹⁹



ANNONS 5-piece cookware set \$14.99. Includes: Saucepan .9L, saucepan with lid 1.7L and pot with lid 2.8L. Stainless steel, plastic and glass. 902.074.02



New VARDAGEN pot with lid \$26.99. Stainless steel with aluminum core. Designer: Preutz/Wihlborg/Braasch/Karlsson. 3L. 203.057.12 **VARDAGEN oven mitt \$4.99.** 80% cotton, 20% flax. 003.038.94

New VARDAGEN pot with lid
\$26⁹⁹

SENIOR casserole with lid
\$54⁹⁹



SENIOR series. Enamelled cast iron. Designer: Kristian Krogh. **Casserole with lid \$54.99.** 3L. 902.328.40 **Frying pan \$39.99.** Ø28cm. 902.648.45

KAVALKAD frying pan, set of 2.
\$12⁹⁹



KAVALKAD frying pan, set of 2 \$12.99. Sizes: dia. 20cm and 26cm. Aluminum coated with Teflon® Classic. 401.393.21

01 BEHÅLLARE water bottle \$3.99. Plastic. Designer: Anna Efverlund. 0.6L. 802.846.60
02 EFTERFRÅGAD vacuum food container \$9.99. Stainless steel. Designer: Anna Efverlund. 0.5L. 402.883.54
03 FESTMÅLTID lunch box \$3.99. Includes: lunch box with 2 removable inserts and 1 lid. Polypropylene. Designer: Anna Efverlund. L19×W13×H6cm. 902.846.50
04-06 FÖRTROLIG food containers. Oven-safe glass and plastic. Designer: Anna Efverlund. L19×W13×H6cm. 902.846.50
04 Food container \$2.99/ea. Ø12, H7cm. 0.4L. 302.337.86
05 Food container \$2.99/ea. Was \$3.49. L13×W19×H7cm. 0.8L. 902.337.88
06 Food container \$5.99/ea. L17×W23×H9cm. 1.5L. 502.337.90



01 BEHÅLLARE
water bottle
\$3.99

04 FÖRTROLIG
food container, 0.4L.
\$2.99/ea

**NEW
LOWER
PRICE**

05 FÖRTROLIG
food container, 0.8L.
Was \$3.49
\$2.99/ea

03 FESTMÅLTID
lunch box
\$3.99

Freeze, reheat and serve leftovers all in the same oven-safe glass container.



Szilvi
Deputy sales manager, Hungary

When there are leftovers or fresh foods that I need to use up soon, I put them in a container near the front of the fridge with a label on it that says 'Eat Me First'. Then I always remember it's there and I don't have to throw away perfectly good food!

FÖRVAR
jar with lid
\$2.99



FÖRVAR jar with lid \$2.99. Glass and plastic. Designer: Carl Öjerstam. H18cm. 1.8L. 000.302.62

INBJUDANDE
tin with lid,
set of 3
\$6.99



INBJUDANDE container with lid, set of 3 \$6.99. Includes: 0.4L (H11.5, Ø7.5cm), 0.6L: (H13, Ø8.5cm) and 1L (H14, Ø10.5cm), 1 of each. Steel. 503.033.87

No wasted food or space – fits 24", deep drawers perfectly with aroma-tight lids for freshness.



01-02 TILLSLUTA dry food jars with lid. Plastic. Designer: K Hagberg/M Hagberg.
01 Dry food jar with lid \$6.99. L15×W11×H12cm. 1L. White 502.336.86
02 Dry food jar with lid \$9.99. L23×W15×H23cm. 4.5L. White 802.574.97

01 New VARDAGEN
jar with lid, 1.8L.
\$6.99



01-03 VARDAGEN jars with lid. Glass and silicon rubber. Designer: Preutz/Wihlborg/Braasch/Karlsson.
01 New Jar with lid \$6.99. 1.8L. 602.919.30
02 Jar with lid \$3.49. 0.3L. 402.919.26
03 Jar with lid \$6.99. 1.9L. 002.919.28

Kitchen extras

Freestanding units and flexible trolleys give you quick and easy ways to get extra storage, workspace and functionality. Sometimes you don't need a new kitchen, just a smarter one.

STENSTORP
kitchen trolley
\$169



STENSTORP kitchen trolley \$169. Solid oak and stainless steel. Designer: Carina Bengs. RA. W16 $\frac{7}{8}$ "x D17 $\frac{3}{4}$ "x H35 $\frac{3}{8}$ ". 202.198.37

RA=REQUIRES ASSEMBLY

A messy and cluttered countertop makes it hard to cook. Here, you have both a practical work area and a handy place to store things away. And the modern look in stainless steel and bamboo means it's a lovely piece of furniture, too.



New RIMFORSA
work bench
\$699

New RIMFORSA work bench \$699. Stainless steel and bamboo. Designer: Ehlén Johansson. RA. L47 $\frac{1}{2}$ "x W24 $\frac{3}{4}$ "x H36 $\frac{1}{4}$ ". 203.250.17

SEKTION makes it easy to add on to your existing kitchen. Build your own unit with your choice of doors and drawers.

NEW LOWER PRICE
SEKTION/BOBBYN
storage unit
Was \$671
\$653



SEKTION wall cabinets with BOBBYN off-white doors and drawer fronts \$653. Was \$671. This combination consists of: SEKTION wall cabinets in melamine foil. BOBBYN doors/drawer fronts in painted finish. MAXIMERA drawers in powder coated steel and melamine foil. UTRUSTA shelves in melamine foil. FÖRBÄTTTRA legs in painted solid birch. FÖRBÄTTTRA cover panel in painted finish. EKBACKEN countertop, cut to size. HISHULT handles/knobs are sold separately. RA. W49x D15 $\frac{1}{2}$ "x H36".

Picking with Delivery service. We collect all your purchased items and deliver them to you. Prices from \$99. See page 309.

NORRÅKER
sideboard
\$199



NORRÅKER sideboard \$199. Clear lacquered solid birch. Designer: J Karlsson/N Karlsson. RA. L47 $\frac{1}{4}$ "x W19 $\frac{5}{8}$ "x H33 $\frac{1}{2}$ ". 102.928.66

New RÅSKOG
trolley
\$34.99



New RÅSKOG trolley \$34.99. Powder-coated steel. Designer: Nike Karlsson. RA. L13 $\frac{3}{4}$ "x W17 $\frac{3}{4}$ "x H30 $\frac{3}{4}$ ". 503.317.62

SUNNERSTA
trolley
\$39.99



SUNNERSTA trolley \$39.99. Powder-coated steel and polypropylene plastic. Designer: Henrik Preutz. RA. L22x W13x H38 $\frac{1}{4}$ ". 703.037.20

SEKTION wall cabinets with VEDDINGE white drawer fronts \$528. This combination consists of: SEKTION wall cabinets in melamine foil. VEDDINGE drawer fronts in painted finish. MAXIMERA drawers in powder coated steel and melamine foil. SKÄRALID leg frames in clear lacquered solid birch. EKBACKEN countertop, cut to size. ERIKSDAL knobs are sold separately. RA. W48 $\frac{3}{4}$ "x D15 $\frac{1}{2}$ "x H35 $\frac{1}{2}$ ".

SEKTION/VEDDINGE
storage unit
\$528



New SEKTION/KALVIA
storage unit
\$936



SEKTION wall cabinets with New KALVIA printed doors \$936. This combination consists of: SEKTION wall cabinets in melamine foil. KALVIA doors in foil finish. UTRUSTA shelves in melamine foil. LIMHAMN legs in lacquered steel and UTRUSTA push opener. RA. W48 $\frac{3}{4}$ "x D15 $\frac{1}{2}$ "x H75". **MÅSTERBY step stool \$39.99.** Recycled PP plastic. W16 $\frac{7}{8}$ "x D15 $\frac{3}{4}$ "x H19 $\frac{5}{8}$ ". 403.320.74

01-02 New GRUNDVATTNET series.

Polypropylene plastic and synthetic rubber.

Designer: Brickstad/Palleschitz/Petersén.

01 Wash tub \$10.99. L15¼xW9xH6¼". 803.142.85

02 Colander \$4.99. L18xW6xH4". 903.142.80

03 New LÅNGUDDEN inset sink, 1 bowl \$119.

Stainless steel. L22xD20½xH7½". 203.248.81 Price includes

LILLVIKEN strainer. 503.254.26

04 IKEA 365+ wine glass \$2.99/ea. Tempered glass.

Designer: Preutz/Wihlborg/Braasch/Karlsson. 30cl. 702.783.63



01 New GRUNDVATTNET wash tub \$10.99

02 New GRUNDVATTNET colander \$4.99

A perfect fit — designed to make the most of LÅNGUDDEN sink space.

New SUNNERSTA series. Designer: Henrik Preutz. **Hook 99¢ /5 pack.** Use the hooks to store your kitchenware on the wall and fit more into your cabinets and drawers. Fits SUNNERSTA rail, utility cart and mini-kitchen.403.037.26 **Container 99¢ /ea.** W12xD11xH13cm. Helps free up space on your countertop while keeping cooking utensils close at hand.Fits SUNNERSTA rail, utility cart and mini-kitchen.503.037.35 **Rail \$2.99.** L60cm. Saves space on the countertop 303.037.22



New SUNNERSTA container 99¢/ea

You're much more likely to eat up your vegetables and fruits when they're temptingly out on display – not hidden at the back of the fridge. So you waste less money and food, while the kitchen looks a bit more colourful, too.

RISATORP basket \$12.99



RISATORP basket \$12.99. Powder-coated steel and clear lacquered solid birch. Designer: Wiebke Braasch. L25xW26xH18cm. 502.816.20



FALSTERBO wall rail with hooks \$29.99

FALSTERBO wall rail with hooks \$29.99. Powder-coated steel. Designer: Mikael Axelsson. L60xD6xH6cm. 803.158.88



RIMFORSA holder with containers, 2 pack. \$19.99

RIMFORSA series. Hook \$1.50 /4 pack. H6cm. Use the hooks to store your kitchenware on the wall and fit more into your cabinets and drawers.702.820.77 **Holder with containers \$19.99/2 pack.** W20xD12, H22cm. 802.820.72 **Rail \$5.99.** L80cm. 902.820.76



FALSTERBO wall shelf \$99

FALSTERBO wall shelf \$99. Powder-coated steel. Designer: Mikael Axelsson. RA. W60xD32xH100cm. 003.158.87

RA=REQUIRES ASSEMBLY

All sorted out

Using smart, space-efficient bins to sort every type of waste makes the task easier. Less time and effort for you, and less waste in the landfill, too.



02 IVAR shelving unit with drawers \$159

01 SAMLA box with lid \$2.49/ea

03 KNODD bin with lid \$24.99

The folding lid makes it easy to open and access what's inside even when stacked.

04 SORTERA waste sorting bin with lid \$15.99/ea

05

06

01 SAMLA box with lid \$2.49/ea. Polypropylene. Designer: Mia Lagerman. W28xD20xH14cm. 5L. 498.716.76 **02 IVAR shelving unit with drawers \$159.** Solid pine and powder-coated steel. RA. W89xD50xH179cm. 491.335.84 **03 KNODD bin with lid \$24.99.** Powder-coated steel. Ø41, H51cm. 40L. 903.153.12 **04 SORTERA waste sorting bin with lid \$15.99/ea.** Polypropylene. W39xD55xH45cm. 60L. 702.558.99 **05-06 KNAGGLIG boxes.** Untreated solid pine. RA. **05 Box \$7.99.** W23xD31xH15cm. 102.923.57 **06 Box \$14.99.** W46xD31xH25cm. 702.923.59

RA=REQUIRES ASSEMBLY

Sort materials for future craft projects into easy-to-carry bins.

TROFAST storage combination with boxes \$71

TROFAST storage combination with boxes \$71. Clear lacquered solid pine and plastic. Designer: Studio Copenhagen. RA. W44xD30xH91cm. 291.030.07



02 New SNÄPP pedal bin, 5L. \$11.99

01-02 New SNÄPP pedal bins. Polypropylene plastic. Designer: Marcus Arvonen. RA. **01 Pedal bin \$18.99.** Ø40, H40cm. 12L. White 902.454.23 **02 Pedal bin \$11.99.** Ø20, H20cm. 5L. Grey 302.454.21



FNISS waste bin \$1.75

FNISS trash basket \$1.75. Polypropylene. Designer: K Hagberg/M Hagberg. Ø28, H28cm. 10L. 402.954.39

01-02 DIMPA waste sorting bags. Polypropylene plastic. **01 Recycling bag \$3.99.** W44xD35xH45cm. 70L. 502.916.38 **02 Recycling bag \$2.99.** W22xD35xH45cm. 35L. 302.916.39

01 DIMPA waste sorting bag, 70L. \$3.99





01

02 **New SANNING**
plate
\$3.50

NEW LOWER PRICE
05 **VARDAGEN**
glass
Was \$7.99/6 pack
\$5.99 /6 pack

03 **New SANNING**
bowl
\$2.50

04

01–04 **New SANNING series.** Tempered glass. Designer: L von Schantz/I Bermúdez. **01 Side plate \$2.50.** Ø19cm. 603.193.83
02 Plate \$3.50. Ø27cm. 103.193.85 **03 Bowl \$2.50.** Ø15cm. 103.193.90 **04 Mug \$2/ea.** 25cl. 003.193.76
05 VARDAGEN glass \$5.99/6 pack. Was \$7.99/6 pack. Tempered glass. Designer: Preutz/Wihlborg/Braasch/Karlsson. 31cl. 002.869.17

Table changers

It doesn't take much to give your table a fresh new look. Little touches can make a big impact.



INBJUDANDE
tray
\$9.99

INBJUDANDE tray \$9.99. Laminated cardboard. Designer: Jennifer Idrizi. Ø43cm. 502.865.09

GRÄDDAD
jug
\$8.99



GRÄDDAD jug \$8.99. Stoneware. Designer: Annie Huldén. 2L. 702.585.05

INBJUDANDE
paper napkin, 30 pack.
\$3.99



INBJUDANDE paper napkin \$3.99/30 pack. Designer: Jennifer Idrizi. L38xW38cm. 502.865.14

ARV
bowl
\$3.99



ARV series. Earthenware. Designer: Sissa Sundling. **Bowl \$3.99.** Ø15cm. 702.346.23 **Side plate \$3.99.** Ø22cm. 902.346.17

GARNERA
serving stand, two tiers
\$16.99



GARNERA serving stand, two tiers \$16.99. Steel. Designer: Gunnel Sahlin. Ø29, H33cm. 102.587.68

INBJUDANDE
tablecloth
\$19.99



INBJUDANDE tablecloth \$19.99. 100% cotton. Designer: Jennifer Idrizi. W145xL240cm. 902.868.33

KALAS series. Polypropylene. Designer: Henrik Preutz.
Plate \$1.79/6 pack. Was \$1.99. Ø19cm. 501.929.59
Tumbler \$1.79/6 pack. Was \$1.99. 101.929.56

NEW LOWER PRICE
KALAS
 plate, 6 pack.
 Was \$1.99
\$1.79



IKEA 365+
 deep plate/bowl
\$4.99



IKEA 365+ deep plate/bowl \$4.99. Feldspar porcelain.
 Designer: Preutz/Wihlborg/Braasch/Karlsson. Ø22cm. 902.797.00

IKEA 365+ mug \$2/ea. Tempered glass.
 Designer: Preutz/Wihlborg/Braasch/Karlsson.
 24cl. 102.797.23
IKEA 365+ coaster \$2.50 / 2 pack. Cork.
 Designer: Preutz/Wihlborg/Braasch/Karlsson.
 Ø9cm. 502.829.45

IKEA 365+
 mug
\$2/ea



Is it a mug, glass or dessert bowl? It's all three in extra durable tempered glass.

FÄRGRIK plate \$3.50. Stoneware.
 Designer: Maria Vinka. Ø27cm. 402.347.90

FÄRGRIK
 plate
\$3.50



NEW LOWER PRICE

IKEA 365+
 carafe with stopper
 Was \$4.99
\$3.99

IKEA 365+ carafe with stopper \$3.99. Was \$4.99. Heat resistant glass.
 Designer: Preutz/Wihlborg/Braasch/Karlsson. 1L. 902.797.19



TRYGG serving bowl \$2.99. Glass Designer: K Hagberg/M Hagberg.
 Ø28cm. 201.324.53

TRYGG
 serving bowl
\$2.99



IVRIG
 red wine glass
\$2.99

IVRIG red wine glass \$2.99.
 Glass. 48cl. 702.583.17



01 New POPPIG tray \$6.99. Laminated cardboard.
 Designer: Elizabeth Q. Cassetti. L43xW33cm. 803.137.52
02 New POPPIG glass \$1.99/ea. Glass, Paint. Designer: Elizabeth Q. Cassetti. 23cl. Green/blue 303.253.14 Blue 803.272.02

01 New POPPIG
 tray
\$6.99



02 New POPPIG
 glass
\$1.99/ea



New POPPIG
 napkin holder
\$2.49



New POPPIG napkin holder \$2.49. Steel. Designer: Elizabeth Q. Cassetti. L15xW3cm. 403.270.82



New POPPIG
 place mat
\$1.99

A bright way to protect your table and dampen the sound of plates and cutlery, too.



New POPPIG place mat \$1.99. Polypropylene. Designer: Elizabeth Q. Cassetti. W37xL37cm. 003.270.84



01 ROMANTISK
tray
\$12⁹⁹

02 New VARDAGEN
teapot
\$9⁹⁹

03 New VARDAGEN
teacup with saucer
\$3⁴⁹

04 VARDAGEN
napkin
\$3⁹⁹/2 pack

05 VARDAGEN
tablecloth
\$19⁹⁹

The softness of cotton and the lustre and firmness of linen – a hard-wearing tablecloth that ages beautifully.

01 ROMANTISK tray \$12.99. Steel. Designer: Sarah Fager. L52xW39cm. 801.756.75 **02–03 New VARDAGEN series** Stoneware. Designer: Preutz/Wihlborg/Braasch/Karlsson. **02 Teapot \$9.99.** 1.2L. 402.893.44 **03 Teacup and saucer \$3.49.** 26cl. 802.883.14 **04–05 VARDAGEN series.** 52% linen, 48% cotton. Designer: Maria Vinka. **04 Napkin \$3.99/2 pack.** L40xW40cm. 902.923.77 **05 Tablecloth \$19.99.** W145xL240cm. 202.878.31



Henrik
Designer, Sweden

VARDAGEN series brings to mind the timeless, traditional and lasting qualities of old-fashioned craftsmanship. We hope you like the attention to detail and the soft, round shapes that create a beautiful frame for your food and drink. Simple, honest and soulful, this is tableware that can bring back memories – and create new ones!



New VARDAGEN
side plate
\$2⁴⁹

New VARDAGEN plates. Stoneware. Designer: Preutz/Wihlborg/Braasch/Karlsson. **Side plate \$2.49.** Ø21cm. 702.892.86 **Plate \$3.50.** Ø26cm. 802.891.82



VARDAGEN
carafe with lid
\$3⁹⁹

New VARDAGEN
bowl, Ø20 cm.
\$3⁹⁹



New VARDAGEN bowls. Glass. Designer: Preutz/Wihlborg/Braasch/Karlsson. **Bowl \$2.99.** Ø15cm. 602.892.63 **Bowl \$3.99.** Ø20cm. 602.892.39

Go ahead and store it in the fridge door – the practical lid prevents spills.

VARDAGEN carafe with lid \$3.99. Glass and silicon rubber. Designer: Preutz/Wihlborg/Braasch/Karlsson. 1.0L. 502.919.21



SKUREN
20-piece cutlery set
\$26⁹⁹

SKUREN 20-piece cutlery set \$26.99. Stainless steel. Designer: Henrik Preutz. 702.589.73



POKAL
wine glass
\$1⁹⁹

POKAL wine glass \$1.99. Glass. 20cl. 102.150.95

At IKEA, quality comes from the inside. We like working with materials that are more sustainable, more affordable and more enjoyable to use. Well really, “likes” would be an understatement. In fact, we LOVE to get down to the nitty-gritty of natural materials.

The thing about quality

– an interview with
Jan Ahlsén

Did you know that it takes about two years to assess a “new” material at IKEA? Together with WWF, we perform a mapping of the material’s sustainability and availability. We never start using a material without doing a proper analysis of potential harm being done to nature and the living creatures around it. On this note, there’s really no one better to talk to about quality and materials other than the material connoisseur himself. Jan Ahlsén, Material & Innovation Specialist, has been with IKEA for nearly 40 years and is nowhere near losing his wit - and passion for natural materials. You could kind of say that it was love at first sight:

“Solid wood is where it all started for me. I was kind of an expert on that once upon a time”, he says with a humble smile. It was by accident I made the switch to bamboo and other natural fibre materials. Now I challenge solid wood,” he winks and chuckles. A tree takes about 70 years to fully grow - light-years compared to the seven years it takes bamboo. “I’ve always had a thing for natural materials. But, it was at IKEA that I fell in love with using materials that take people and planet into consideration.” >>

New GRÖNADAL rocking chair \$149.
Clear-lacquered rattan, solid ash and steel.
Designer: Lisa Hilland. RA.
W57×D82×H86cm. 903.200.97



SINNERLIG stool \$59.99.

Cork and powder-coated steel. Designer:
Ilse Crawford. RA. Ø35, H45cm. 103.057.79

“Many individuals here have influenced me. The values – making more from less – resonate with me, and the way I like working.” Going from being a technician, to a purchaser, to just about a little bit of everything, he still describes his role as continuous growth and development. “It’s the same kind of feeling in my body, he smiles. It never stops being interesting to me.”

Do you have a favourite material?

There’s a long pause. He squints upwards and says, “I can’t say I have a specific one favourite, but when I choose materials for



RIMFORSA work bench \$699. Stainless steel and bamboo. Designer: Ehlén Johansson.
RA. L120×W63×H92cm. 203.250.17

“Quality is about form and function. It’s about fulfilling my expectations, that the furniture works as I expect it to work when I use it. Quality is free.”

Jan Ahlsén, Material & Innovation specialist

myself, it’s always linked to what I do here at IKEA. I had a good learning experience together with Ilse Crawford, during the development of the SINNERLIG collection, about tactility and feeling – the relationship that we as humans have to material. And darn it, she’s quite good at that. I think many of our customers link their perception of quality at IKEA with the assembly of our products. But I believe we all have this sense for materials. Just go look at people shopping for clothes. The first thing they do – they’re touching the material. If it feels good, like what you expect it to feel like,

then oh wow, it’s a different quality.” He chuckles, and talks about how he went to visit a store in Älmhult to observe peoples’ shopping habits.

What is quality to you?

“Quality is about form and function. It’s about fulfilling my expectations, that the furniture works as I expect it to work when I use it. Quality is free. Quality itself doesn’t cost anything. It’s the errors that cost IKEA and the consumer money. When it’s incorrectly made, then it starts costing money. And back to function – if I should drive a



NORRÅKER chair \$99.

Stained, clear lacquered solid birch and birch veneer. Designer: J Karlsson/
N Karlsson. RA. W41×D50×H81cm.
White birch 402.753.42

Below | Jan and RIMFORSA, the workbench made of bamboo – a clear favourite of Jan’s when it comes to natural materials.

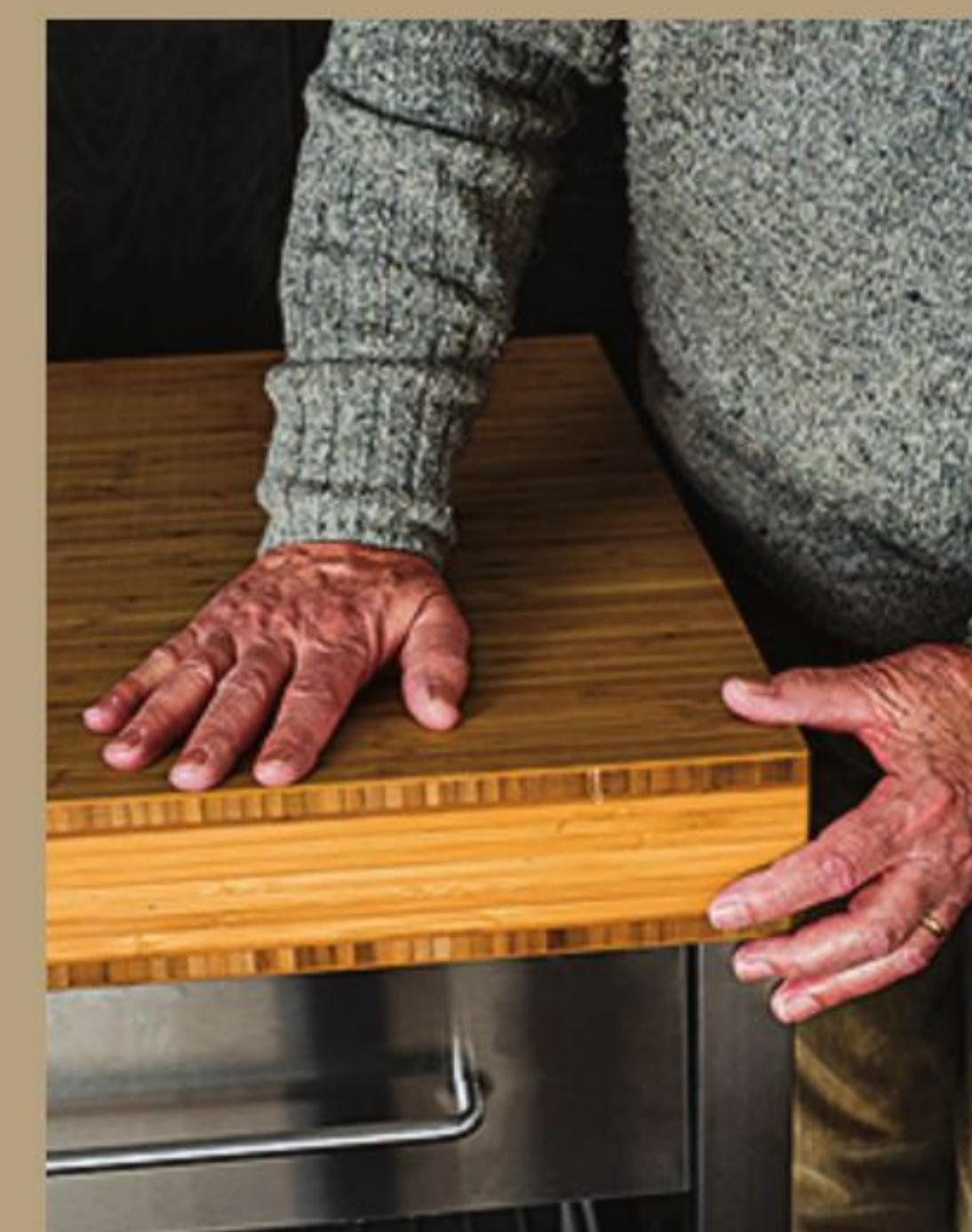

car in the Sahara desert, and I have a choice between an ordinary SUV and a luxury car, which one do you think would fit best? A higher price doesn’t necessarily reinvent quality either.”

In terms of quality, what’s important for people to look for when purchasing furniture?

“It’s a lot about where you are in life. If I’m married and have small kids, then of course I would buy a table with a melamine surface. I think we should help the customer with this. We need to tell them if they have kids who sit and hammer with toys, and their breakfast is all over the place, then there, that’s the table for them. But it can also be twisted around. A couple of years back IKEA sold a dining table in solid pine, with no surface treatment on it. I had it at home, with small kids at the time. It looked terrible after a couple of weeks with marks and scratches everywhere. One year later it was beautiful. Every mark was like a memory. My table became my history book. This is of course if you’re prepared to do some maintenance over time.”

How is IKEA utilizing natural materials in the near future?

“IKEA is a fantastic company because we dare to do things differently. If you look ahead to 2020, 2030, we know already that we’ll use a lot more material. There’s a limit to some materials, but we’re also aware of materials that don’t have those same limitations. Bamboo for example, you plant it, seven years later you can harvest it, without having to replant it. The roots take care of that. Extremely sustainable material, right? So, why don’t we do more? I can mention cork as well. We only “borrow” the bark, we never cut down the trees.”

“We’re also very aware of the waste that is being generated in the process, and have

a lot of initiatives around this today. Going forward, we’ll take care of bamboo waste by mixing it together with other natural materials. This turns into something that looks a lot like ceramic,” Jan points to his coffee cup on the table in front of us. “Technically it’s all there, now we just need to make it happen! I think there’s a lot of promise there, even from a customer perspective, and IKEA is very much at the forefront of this.”

According to Jan, rattan and paper are two other materials to keep an eye on in the future. They’re great to use for storage because it allows items to breathe and, as Jan expresses: “That gives us a warmer feeling at home.”

What do you think future IKEA furniture will look like?

“I think we’ll try to incorporate natural fibres into our self-assembly products a lot more. They can be used in bookshelves, kitchens and bathrooms to give a warmer feeling. The surface treatment will remain as is, because it serves as good function. By having the natural fibres in there, it speaks to my heart.”

“For me, the future is about handicraft. You can go to IKEA and buy a rattan chair that’s handmade. A human being has made it. That’s amazing! So actually – it’s a work of art. We might not think about it, but we have a lot of works of art at IKEA. That’s one thing I hope we will be able to tell the customer more about that. My dream is to have a tag on the product with a QR code that can show a short movie about the person that wove the chair. It’s about storytelling. It’s human.” ■

From dining to everything

Three meals a day plus homework, snacks, hobbies, games and more. So much happens around the dining table. Find the one that fits your family, your space and your style.

01 NORRÅKER chair \$99. Stained, clear lacquered solid birch and birch veneer. Designer: J Karlsson/N Karlsson. RA. W41×D50×H81cm. 003.015.26
02 IVAR chair \$39.99. Solid pine. RA. W41×D50×H95cm. 902.639.02
03 New NORRÅRYD chair \$99. Stained, clear lacquered solid beech and beech veneer. Designer: Nike Karlsson. RA. W47×D51×H83cm. 802.730.96



STORNÅS extendable table \$469. Stained, clear lacquered solid pine. Designer: Carina Bengs. RA. L201/247/293×W105×H74cm. 601.523.40 **HENRIKSDAL chair \$119/ea.** Solid birch and 53% linen, 47% viscose/rayon. RA. W51×D58×H97cm. 098.621.79 **ÄLVANGEN double pendant lamp \$129.** Glass and steel. W101-131cm. 502.632.92

If it's sturdy enough for life in the IKEA Restaurant, it's sturdy enough for your home. Made from strong, solid birch to keep its handcraft feel despite heavy wear and tear – and the inevitable spills.



NORRÅKER table \$249

NORRÅKER series. Designer: J Karlsson/N Karlsson. RA. **Table \$249.** Stained, clear lacquered solid birch. L125×W74×H74cm. 002.908.15 **Chair \$99/ea.** Stained, clear lacquered solid birch and birch veneer. W41×D50×H81cm. 402.753.42

Easily extends to seat six using a leaf stored under the table top.



INGATORP extendable table \$369

INGATORP extendable table \$369. Stained, clear lacquered beech veneer. Designer: Carina Bengs. RA. Ø110/155×H74cm. 802.170.72



GAMLEBY gateleg table \$349

GAMLEBY series. Stained, clear lacquered solid pine. RA. **Gateleg table \$349.** L67/134/201×W78×H74cm. 602.470.27 **Chair \$60/ea.** W42×D50×H85cm. 602.470.51

RA=REQUIRES ASSEMBLY

INGOLF junior chair \$59.99. Painted solid rubberwood. Designer: Carina Bengs. RA. Seat W30×D25×H52cm. 901.464.56



INGOLF junior chair \$59.99

Delivery service. We can bring your purchases to your home or office. Prices from \$79. See page 309.

Create your own dining table. The BACKARYD frame combines with your choice of table top.



New BACKARYD/
ÖVRARYD
table
\$159

New BACKARYD/ÖVRARYD table \$159. Powder coated steel, particleboard and bamboo. RA. L150xW78xH75cm. 791.407.00

JANINGE
chair

\$79⁹⁹/ea



JANINGE chair \$79.99/ea. Reinforced polypropylene. Designer: John/Jonas/Petrus/Paul/Caroline. W50xD46xH76cm. 602.460.80

ADDE
chair
\$12⁹⁹



ADDE chair \$12.99. Powder-coated steel and polypropylene plastic. Designer: Marcus Arvonen. RA. W39xD47xH77cm. 902.142.85

Maintenance-free and easy to store – you can stack the chairs and fold the table. And, they're approved for business use!



TUNHOLMEN
table, outdoor
\$109

TUNHOLMEN series. Powder-coated aluminum. Designer: David Wahl. RA. Table, outdoor \$109. L58xW69xH71cm. 602.594.97 Chair, outdoor \$80. W55xD55xH78cm. 502.595.01

LISABO
table

\$259



LISABO table \$259. Clear lacquered ash veneer and solid birch. Designer: K Hagberg/M Hagberg. RA. L140xW78xH74cm. 702.943.39 LEIFARNE chair \$55/ea. Chrome-plated steel and plastic. RA. W52xD50xH87cm. Light blue/Broringe chrome-plated 891.278.02

RA=REQUIRES ASSEMBLY

New BERNHARD
chair
\$189/ea

Built-in storage in the centre, to keep things tucked away but always in reach.



BEKANT conference table \$329. Stained, lacquered ash veneer and powder-coated steel. RA. L140xW140xH73cm. 490.062.70 New BERNHARD chair \$189/ea. Chrome-plated steel and leather. RA. W49xD50xH77cm. Chrome-plated/Mjuk orange 703.347.31 SEKOND/NYMÖ shade and cord set \$64.99. Polyester and plastic. RA. Ø59cm. Cord length 4.7m. 402.793.78/302.814.14

BLÅMES highchair with tray
\$69.99. Painted solid rubberwood and polypropylene plastic. Designer: Tina Christensen. RA. Seat W30xD24xH56cm. 101.690.03

BLÅMES
highchair with tray
\$69⁹⁹



BJURSTA
extendable table

\$289

Sit back and relax in padded chairs with removable covers you can change for a new look.



BJURSTA extendable table \$289. Stained, clear lacquered ash veneer. Designer: Tord Björklund. RA. L175/218/260xW95xH74cm. 701.162.62 HENRIKSDAL chair \$99/ea. Solid oak, Stain, Clear acrylic lacquer. RA. W54xD58xH97cm. Brown-black/Linneryd natural 898.745.12

Delivery service. We can bring your purchases to your home or business. Prices from \$79. See page 309.



RÅSKOG
stool
\$29⁹⁹/ea

RÅSKOG stool \$29.99. Powder-coated steel. Designer: Nike Karlsson. RA. W44xD44xH45cm. 803.083.93



NISSE
folding chair

\$19⁹⁹/ea

The top folds down to save space, and you can mount it at bar table height, too.

BJURSTA wall-mounted drop-leaf table \$49.99. Stained, clear lacquered ash veneer/powder-coated steel. RA. W90xD50cm. 802.175.24 **NISSE folding chair \$19.99/ea.** Powder-coated steel and polypropylene plastic. W45xD47xH76cm. 301.150.66 **HEKTAR pendant lamp \$39.99.** Steel and aluminum. Ø22, H20cm. Cord length 1.4m. Dark grey 402.165.31

INGOLF
chair

\$59⁹⁹/ea



INGATORP drop-leaf table \$159. Stained, clear lacquered solid pine. Designer: Carina Bengs. RA. L59/88/117xW78xH73cm. 802.214.27 **INGOLF chair \$59.99/ea.** Stained, clear lacquered solid pine. Designer: Carina Bengs. RA. W43xD52xH91cm. 602.178.22 **RANARP pendant lamp \$49.99.** Powder coated steel and plastic. Ø38cm. Black 003.296.34



MARIUS
stool
\$6⁹⁹/ea

MARIUS stool \$6.99/ea. Powder-coated steel and polypropylene plastic. Designer: Ola Wihlborg. RA. Seat Ø32, H45cm. 101.356.59

NORDEN
gateleg table
\$299



NORDEN gateleg table \$299. Painted solid birch and particleboard. RA. L26/89/152xW80xH74cm. 702.902.23

Your new not-so secret recipe



NEW
LOWER
PRICE

LERHAMN

table and 4 chairs
Was \$309-

\$299

A sturdy table with a solid pine wood surface, and matching chairs. It may be a safe bet, but why not? LERHAMN is to your kitchen, what a sprinkle of olive oil is to your cooking. How can you go wrong with that?

LERHAMN table and 4 chairs \$299. Was \$309. Clear lacquered solid pine. Cover: 35% cotton, 65% polyester. Designer: Nike Karlsson. Table RA. L118xW74xH73cm. Black-brown/Vittaryd beige 590.071.70

Shop online at IKEA.ca

NORRÅKER
chair
\$99/ea

IKEA 365+
mug
\$2/ea

Let's get this show on the road

A cozy little cafe, an elegant boutique, a slick creative studio? Whatever kind of company you dream about opening, IKEA BUSINESS can help you to reach your potential in the most cost-effective way.

At [IKEA.ca](https://www.ikea.ca) and in your local IKEA store, you can see a wide range of furniture and accessories that we can recommend to meet the needs of your business. For your convenience we offer services such as Picking with Delivery, Delivery, and Assembly for an additional cost*.

So you can focus on your future business, rather than the fixtures and fittings.

To start making your dream a reality, please go to [IKEA.ca/BUSINESS](https://www.ikea.ca/BUSINESS) or talk to us in store.

*Terms and conditions apply.

NORRÅKER chair \$99/ea.
Stained, clear lacquered solid birch and birch veneer. Designer: J Karlsson/N Karlsson. RA. W41xD50xH81cm. 402.753.42
IKEA 365+ mug \$2/ea.
Feldspar porcelain. Designer: Preutz/Wihlborg/Braasch/Karlsson. 24cl. 202.829.42

RA=REQUIRES ASSEMBLY

Make it work for you

Standing up in the living room or maybe sitting in bed? Choose the laptop solution that supports where you work best.

BYLLAN
laptop support
\$16⁹⁹

Creates a flat, stable surface for your laptop, so you can work wherever you're most comfortable.

BYLLAN laptop support \$16.99. 100% cotton and plastic. RA. W51×D38×H8cm. 102.782.43

VITTSJÖ laptop stand \$26.99. Powder-coated steel, tempered glass and foil finish. Designer: Johan Kroon. RA. W35×D55×H65cm. 303.064.76



VITTSJÖ
laptop stand
\$26⁹⁹

ISBERGET
tablet stand
\$1⁹⁹



ISBERGET tablet stand \$1.99. Polystyrene plastic. Designer: Sarah Fager. W25×D25×H9cm. 203.025.96

You can easily reach your cables and chargers inside, thanks to the fold-down flap.



NORRÅSEN
laptop table
\$119

NORRÅSEN laptop table \$119. Clear lacquered solid pine. RA. W79×L40×H74cm 002.606.77

IKEA PS 2014
standing laptop station
\$69⁹⁹



IKEA PS 2014 standing laptop station \$69.99. Powder-coated steel. Designer: David Wahl. RA. W45×D33×H96cm. 202.684.65

01

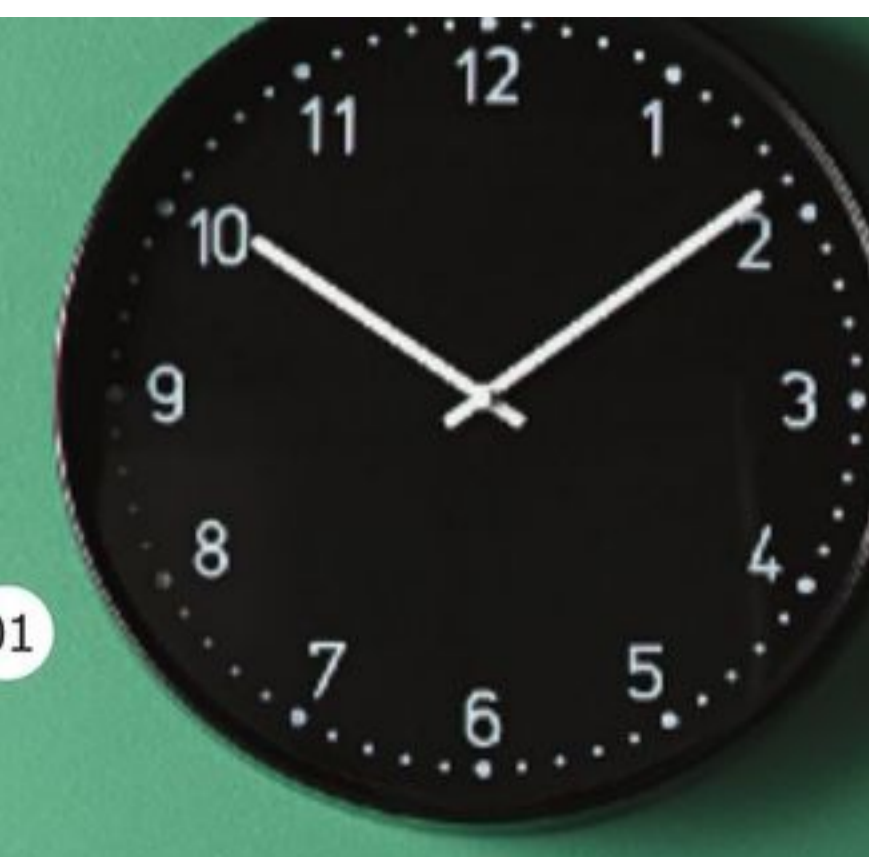

02 **JANSJÖ**
LED work lamp
\$16⁹⁹



03 **New KNOTTEN**
standing desk
\$189

05 **New SKUBBARE**
basket
\$9⁹⁹



01 BONDIS wall clock \$24.99. Steel and glass. Ø38cm. 701.524.67 **02 JANSJÖ LED work lamp \$16.99.** Painted aluminum and steel. Designer: A Efverlund/J Jelinek. RA. H60cm. Copper coloured 703.102.02 **03 New KNOTTEN standing desk \$189.** Tinted, clear lacquered solid birch. Designer: K Hagberg/M Hagberg. RA. W62×D48×H105cm. 302.994.85 **04 TJENA box with compartments \$3.99.** Paper. RA. W27×D35× H10cm. 602.636.06 **05 New SKUBBARE basket \$9.99.** 100% polyester. W36×D25×H38cm. Natural/blue 003.263.05

RA=REQUIRES ASSEMBLY



Åsa
Product developer, Sweden

For many of us, work is no longer a place – work now happens everywhere. But whether you work in the office, at home or on the go, you still want your own comfortable space. So we develop workspace furniture that makes it easier to get the job done – and that looks great, too.



LISABO
desk
\$179

LISABO desk \$179. Clear lacquered ash veneer and solid birch. Designer: K Hagberg/M Hagberg. RA. W118×D45×H74cm. 302.990.70



New KULLABERG
swivel chair
\$69⁹⁹

The look is rustic and vintage, while the comforts are all modern.

New KULLABERG series. Clear lacquered pine veneer and powder-coated steel. RA. **Swivel chair \$69.99.** A desk chair inspired by old-fashioned industrial-style chairs, complete with modern functions. W42×D39×H44cm. 103.203.41 **Desk \$189.** Designer: Ebba Strandmark. W110×D70×H75cm. 691.625.99 **RANARP work lamp \$39.99.** Powder coated steel and plastic. RA. H42cm. Black 103.313.92

FJÄLLA
magazine file, 2 pack.
\$7⁹⁹



FJÄLLA magazine file \$7.99/2 pack. Paper and steel. RA. W10×D26×H32cm. Yellow 603.253.22



New ÖRFJÄLL
junior chair
\$59

New ÖRFJÄLL junior chair \$59. Cover: 100% polyester. Designer: S Holmbäck/U Nordentoft. RA. Seat W39×D34×H37–50cm. 103.270.69

RA=REQUIRES ASSEMBLY



New PÅHL desk with add-on unit \$119. Acrylic paint and powder-coated steel. RA. W96×D58cm. 991.289.57 **JULES junior desk chair \$39.99.** Seat: painted beech plywood. RA. Seat W35×D32×H38–50cm. 198.850.43 **HÅRTE LED work lamp \$18.99.** Powder coated steel, aluminum and ABS plastic. H32cm. Green/Silver 003.220.10

New PÅHL
desk with add-on unit
\$119

The desk has three height settings, so it can easily grow with your child.



LINNMON/ADILS table \$29.99 Painted finish and powder-coated steel. RAL100×W60×H74cm. 691.335.97 **LENNART drawer unit \$14.99.** Powder-coated steel and plastic. Designer: Jon Karlsson. RA. W30×D34×H56cm. 303.261.77

LENNART
drawer unit
\$14⁹⁹



The feeling of home more than the office – a tidy workspace for when you don't need, or can't fit in, a big desk. And you can still get a stack of paper in each of the three drawers.

LILLÅSEN
desk
\$179

LILLÅSEN desk \$179. Powder-coated steel and bamboo. Designer: Mikael Axelsson. L102×W49×H74cm. RA. 902.782.77 **VÅGSBERG/SPORREN swivel chair \$69.99.** Stained, lacquered birch veneer/powder-coated steel. RA. Seat W45×D39×H42–54cm. 890.066.83

The best commute

Working from the comfort of home feels even better with a furnishing solution that supports how you work.



ALEX desk \$169. Painted finish and powder-coated steel. Designer: Johanna Asshoff. RA. W131×D60×H76cm. 902.607.10 **ALEX drawer unit \$80.** Painted finish. Designer: Johanna Asshoff. RA. W36×D58×H70cm. 002.612.95 **VOLMAR swivel chair \$229.** Stationary cover: 100% polyester. Designer: Henrik Preutz. RA. Seat W41×D44×H40–54cm. Unnered grey 803.155.72

Cables and cords stay inside for a clutter-free outside.

ALEX
desk
\$169

FJÄLLBERGET
conference chair
\$229



FJÄLLBERGET conference chair \$229. Stationary cover: 100% wool. Designer: H Preutz/N Karlsson. RA. Seat W42×D40×H43–56cm. Birch veneer/Ulleivi medium grey 202.507.19



LIATORP
desk
\$359



You can put the storage unit on the right or left. The shelves inside are adjustable, too.

MICKE
desk
\$99



MICKE desk \$99. Painted finish and powder-coated steel. Designer: Henrik Preutz. RA. W105×D50×H75cm. 102.447.43 **FLINTAN swivel chair \$79.99.** Stationary cover: 100% polyester. Designer: Henrik Preutz. RA. Seat W47×D48×H47–60cm. Havhult turquoise 802.838.92

RA=REQUIRES ASSEMBLY

Bright ideas

Since you can use one rechargeable battery up to 1,500 times instead of using 1,500 disposable batteries, it's better for the environment and your budget. Plus, wireless chargers make charging gadgets much more convenient – and tidier, too.

Where are the batteries? Right here, neatly stored, charged and ready to go.

01 New STORHÖGEN battery charger with storage \$39.99

02 New LADDA rechargeable battery \$8.99/4 pack.

01 New STORHÖGEN battery charger with storage \$39.99. Polycarbonate plastic, ABS plastic. L22xW18xH4cm. Designer: Håkan Olsson. RA. 003.036.48 **02 New LADDA rechargeable battery \$8.99/4 pack.** HR6 AA 1.2V 2450mAh 703.038.76

Turn any furniture you own into a wireless charging station with JYSSEN, or place in pre-drilled holes in IKEA desks.

JYSSEN wireless charger \$39.99

JYSSEN wireless charger \$39.99. Plastic and synthetic rubber. Ø9, H10cm. 302.918.75 **MICKE desk \$59.99.** Painted finish and powder-coated steel. Designer: Henrik Preutz. RA. W73xD50xH75cm. 302.130.76

Some smartphones will need a cover to charge wirelessly. VITAHULT charging covers are available at IKEA. All wireless charging products are made to work with Qi-enabled devices.

NORDMÄRKE triple pad for wireless charging \$79.99. Plastic and synthetic rubber. Designer: David Wahl. L31cm. 103.083.15

Wirelessly charges three devices at the same time... and a fourth with the USB port.

NORDMÄRKE triple pad for wireless charging \$79.99

Makes it easy to charge two batteries on the go.

VINNINGE battery charger \$3.99. USB plug-in. Polycarbonate plastic. L8cm. 703.036.35 **New LADDA rechargeable battery \$4.99/4 pack.** HR6 AA 1.2V 1000mAh 203.038.74

VINNINGE battery charger \$3.99

ROMMA cable management box with lid \$9.99. ABS plastic. Designer: David Wahl. W33xD15xH14cm. 902.898.36

NORDLI nightstand with wireless charging \$139. Painted finish and plastic. RA. W30xD50xH67cm. 090.949.52

NORDLI nightstand with wireless charging \$139

VARV table lamp with wireless charging \$79.99

Charge your devices with the wireless charger or the built-in USB port.

VARV series. Steel, plastic, 82% nylon and 18% polyurethane. Designer: Eva Lilja Löwenhielm. RA. **Table lamp with wireless charging \$79.99.** H52cm. 702.807.09 **Floor lamp with wireless charging \$129.** H169cm. 202.807.02

RA=REQUIRES ASSEMBLY

Metal lamps with textile cords shine with quality details and a retro design.



01

02 **New RANARP**
floor/reading lamp
\$59⁹⁹

03

04 **New RANARP**
work lamp
\$39⁹⁹

01-04 New RANARP series. Powder-coated steel, RA. **01 Pendant lamp \$49.99.** Ø38cm. Gives a directed light. Good for lighting dining tables or a bar area. Light bulb sold separately. IKEA recommends LED bulb E26 400 lumen globe opal white. 003.296.34 **02 Floor/reading lamp \$59.99.** H153cm. 003.313.83 **03 Wall/clamp spotlight \$29.99.** W14xD34. Ø14cm. 803.314.02 **04 Work lamp \$39.99.** H42cm.103.313.92

RA=REQUIRES ASSEMBLY

Light where you want it

Our reading lamps, spotlights and pendants shine light on specific areas – such as on a book, dining table, wardrobe or worktop. They make everything you do at home a little easier... and create an atmosphere for feeling good, too.



HÄRTE
LED work lamp
\$18⁹⁹/ea

A flexible LED lamp that travels with your laptop – powered via USB or ordinary outlet.

HÄRTE LED work lamp \$18.99/ea. Built-in LED light source. Powder-coated steel, aluminum and ABS plastic. Designer: Carl Öjerstam. H32cm. White/silver-colour 902.382.67 Green/silver colour 003.220.10

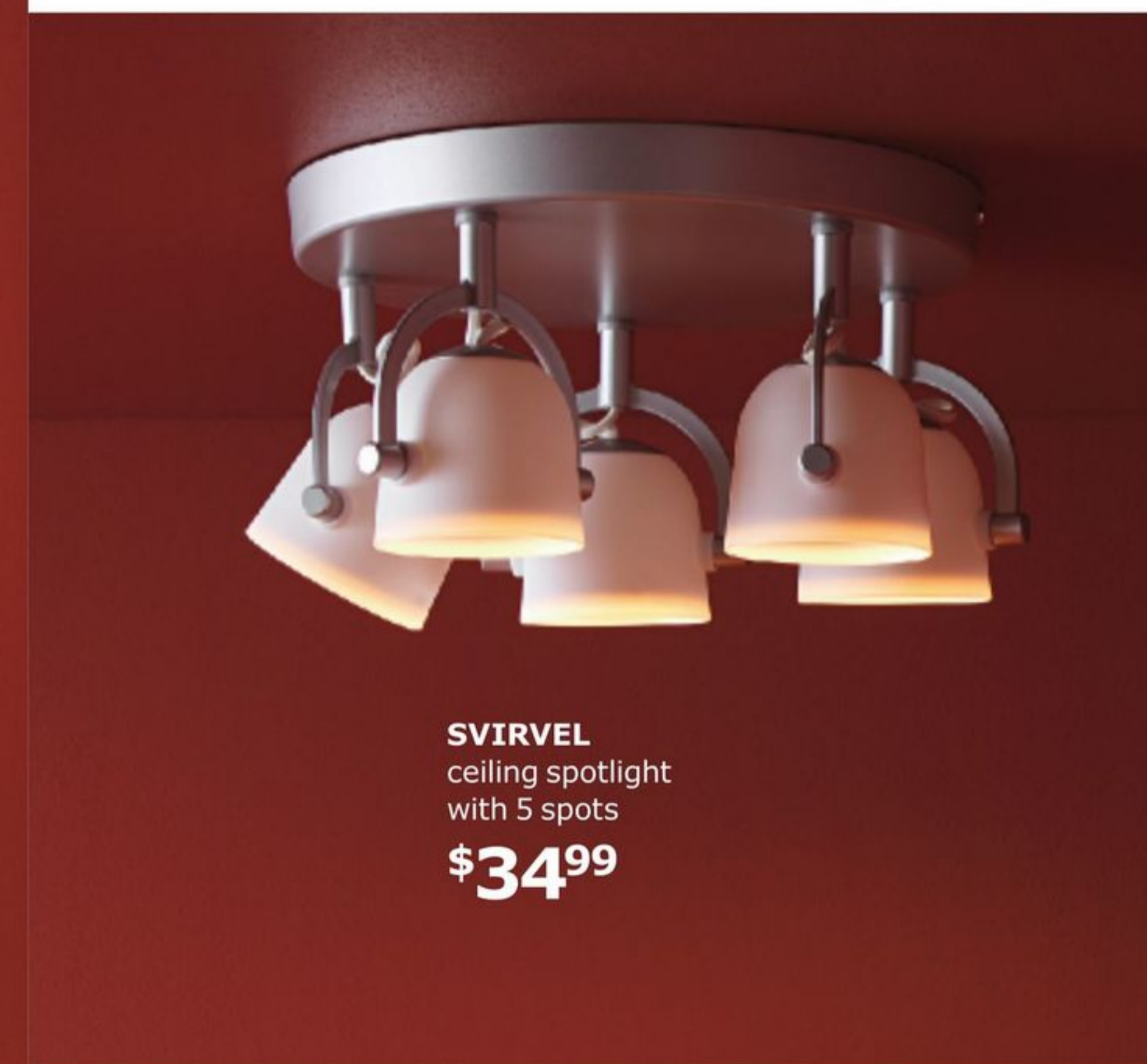

SVIRVEL
ceiling spotlight
with 5 spots
\$34⁹⁹

SVIRVEL ceiling spotlight with 5 spots \$34.99. Painted steel and polypropylene plastic. Designer: C Martin/M Elebäck. Ø30cm. 903.044.98



You can use it as a clamp spotlight on a shelf or mount it to the wall.

HEKTAR wall/clamp spotlight \$19.99. Steel and aluminum. Designer: Ola Wihlborg. Max D22cm. 502.165.40

HEKTAR
wall/clamp spotlight
\$19⁹⁹



MELODI
pendant lamp
\$9⁹⁹

MELODI pendant lamp \$9.99. Plastic. Designer: Monika Mulder. Ø28cm.200.382.19



Younes
Lighting specialist, UAE

Mood lighting softens the contrast between general and directed light, so that you can create a cozy atmosphere to relax in after a long day. For complete control over the mood in your room and to express your individual style, you can use any combination of dimmable table and floor lamps, picture lights, candles or decorative lights.

01 SEKOND/NYMÖ
Cord set/shade
\$39



02 New LAUTERS/JÄRA
floor lamp/shade
\$76



03 New LAUTERS/JÄRA
table lamp/shade
\$39⁹⁹



Gives the cozy, flickering light of a real candle without the risk of fire or burns (especially with young children).



04 STÖPEN
LED block candle,
set of 3
\$12⁹⁹



01 SEKOND/ NYMÖ cord set/shade \$39. Textile, 100% polyester and plastic. Designer: Lycke von Schantz. Cord length L1.8m. Ø37. Cord and shade are sold separately. 002.637.08/402.979.33 **02 New LAUTERS /JÄRA floor lamp/shade \$76.** Solid acacia, 100% polyester. Designer: A Wallin Irinarchos/L Widén. RA . H135cm. Ø45cm. Base and shade are sold separately. 803.029.42/302.062.12 **03 New LAUTERS/ JÄRA table lamp/shade \$39.99.** Solid acacia, 100% polyester. Designer: A Wallin Irinarchos/L Widén. RA. H45cm. Ø23cm. Base and shade are sold separately. 403.029.63/202.044.83 **04 STÖPEN LED block candle, set of 3 \$12.99.** Battery-operated. Polypropylene. 202.827.82

RA=REQUIRES ASSEMBLY

ÅRSTID
wall lamp
\$19⁹⁹



ÅRSTID series.
Brass coloured nickel-plated steel,
70% polyester and 30% cotton.
Brass/white.
Wall lamp \$19.99. D38cm.
703.213.90
Table lamp \$19.99. H55cm.
803.213.80



ÅRSTID
table lamp
\$19⁹⁹

RODD/EKÅS
floor lamp/shade
\$37⁹⁹



Create your own light pattern by adjusting the perforations in the shade.

New ÄNGLAND
table lamp
\$24⁹⁹



New ÄNGLAND table lamp \$24.99. Powder-coated steel and 100% polyester. RA. H57cm. Ø30cm. 502.912.85

KAJUTA
table lamp
\$12⁹⁹/ea



KAJUTA table lamp \$12.99/ea. Powder-coated steel and plastic. Designer: David Wahl. RA. H30cm. Dark pink 803.080.91 Light blue 403.080.69

RODD/EKÅS floor lamp/shade \$37.99. Nickel-plated steel, Polystyrene plastic, 100% cotton and steel. RA. H132cm. Ø34cm. Base and shade are sold separately. 301.924.13 /801.246.57



01 SEKOND/REGOLIT
cord set/shade
\$14⁹⁹



02 IKEA PS 2014
pendant lamp
\$159/ea



03 HEMMA/ÖVERUD
cord set/shade
\$57⁹⁹



Simply pull the strings to go from softer mood light to brighter general light – and see the pattern on the wall change, too.

01 SEKOND/REGOLIT cord set/shade \$14.99. Textile and plastic, Rice paper. RA. L1.8m, Ø45cm. 002.637.08/ 701.034.10. Cord and shade are sold separately. **02 IKEA PS 2014 pendant lamp \$159/ea.** Plastic and aluminum. Designer: David Wahl. RA. Ø52cm. 003.049.16 White/silver colour 003.049.21 **03 HEMMA/ÖVERUD cord set/shade \$57.99.** Powder-coated steel. Designer: A Wallin Irinarchos/L Widén. RA. L4.7m, Ø43. White/copper colour 101.758.10/102.979.20 Cord and shade are sold separately.

RA=REQUIRES ASSEMBLY



SMILA SOL
ceiling lamp
\$29⁹⁹

SMILA SOL ceiling lamp \$29.99. Polypropylene plastic. Designer: Anna Efverlund. RA. Ø67, H12.5cm. For ceiling installation only. 500.728.86

LYSBOJ
ceiling lamp
\$7⁹⁹



LYSBOJ ceiling lamp \$7.99. Polypropylene plastic. Designer: Henrik Preutz. RA. Ø31cm. Due to the built-in overheating protection, this lamp can only be used with an energy efficient light bulb, max. 13 watts. 202.835.88



ÄLVÄNGEN
ceiling lamp
\$24⁹⁹

ÄLVÄNGEN ceiling lamp \$24.99. Glass and steel. Designer: Ehlén Johansson. RA. Ø20cm. 002.633.03

VARV
ceiling lamp
\$49⁹⁹



VARV ceiling lamp \$49.99. Nylon and steel. Designer: Eva Lilja Löwenhielm. RA. Ø55cm. 702.774.72



New HÖLJES
ceiling lamp
\$39⁹⁹

New HÖLJES ceiling lamp \$39.99. Glass and steel. RA. Ø25cm. 603.257.94

Comfort that's classic

Add inviting seating all over the home. With a wide choice of patterns, colours and shapes, you can add comfort that suits your style and the furnishings you already have.



STOCKSUND
chaise longue
\$689

STOCKSUND chaise longue \$689. Cover: 85% cotton, 15% polyester RA. W92xD153xH89cm. Hovsten grey/white/black/wood 691.293.74

EKTORP loveseat and chaise longue \$899. Cover: 100% polyester. RA. W252xD88/163xH88cm. Nordvalla dark beige. 091.291.69



The chaise longue can go on the left or right, and you can switch it whenever you'd like.



EKTORP
loveseat and
chaise longue
\$899



EKTORP
loveseat
\$599

EKTORP loveseat \$599. Cover: 100% cotton. RA. W179xD88xH88cm. Videslund multicolour 091.291.93 **BYHOLMA armchair \$99.** Stained, clear lacquered rattan. W68xD72xH92cm. 601.583.04 Chair cushion sold separately.



STOCKSUND
loveseat
\$799

Extra wide, deep and soft, with pocket springs in the cushion for extra comfort.



STOCKSUND series. Armchair \$599. Cover: 80% cotton and 20% polyester. RA. W92xD95xH89cm. Ramvallen blue/white/black/wood. 191.293.24 **Loveseat \$799.** Cover: 100% polyester. RA. W154xD95xH89cm. Ljungen blue/black/wood 691.297.60



TIDAFORS
sofa
\$849

TIDAFORS sofa \$849. Attached cover: cotton, viscose, polyester and linen. Designer: Ola Wihlborg. RA. W230xD95xH99cm. Hensta dark brown 102.769.32



EKTORP
armchair
\$429

Lift the top of the footstool to find hidden storage space inside.

EKTORP series. Cover: 100% polyester. RA. Nordvalla light blue. **Armchair \$429.** W104xD88xH88cm. 391.290.97 **Footstool \$149.** L82xW62xH44cm. 991.291.17

RA=REQUIRES ASSEMBLY

New VALLENTUNA
3 seat sectional
\$1015

Use the modules by themselves or combine and rearrange into any shape or size – with your choice of covers, too.

New VALLENTUNA 3 seat sectional \$1015. Fixed cover Orrsta light grey: 65% polyester, 35% cotton. Fixed cover Funnarp black/beige: 85% cotton, 15% polyester. RA. W273xD93xH104cm. Orrsta light grey/Funnarp black/beige 691.613.97

SÖDERHAMN chaise longue \$450. Cover: 53% cotton, 47% polyester. RA. W93xD151xH83cm. Finnsta turquoise 391.357.48

SÖDERHAMN
chaise longue
\$450

It will only get better with age. The leather will become softer and darker over time.

STOCKHOLM
sofa
\$2199

STOCKHOLM sofa \$2199. Full-grain leather. Designer: Niels Gammelgaard. RA. W211xD88xH80cm. Seglora natural 202.450.49

It's packaged efficiently so you can easily take it home on the subway or bus.

KNOPPARP
loveseat
\$149

KNOPPARP loveseat \$149. Cover: 100% polyester. Designer: Nike Karlsson. RA. W119xD76xH69cm. 102.651.13

KLIPPAN
loveseat
\$399

KLIPPAN loveseat \$399. Cover: 100% cotton. W180xD88xH66cm. RA. Glottra multicolour 291.302.37

NOCKEBY
loveseat with chaise longue left
\$1459

NOCKEBY loveseat with chaise longue left \$1459. Cover: 78% cotton, 22% polyester. RA. W277xD97/175xH82cm. Tallmyra light beige/chrome-plated 591.504.36

KIVIK
sofa
\$749

KIVIK sofa \$749. Cover: cotton, linen, viscose/rayon and polyester. RA. W228xD95xH83cm. Isunda beige 090.058.90

So many shapes, styles and sizes to choose from in the NORSBORG series – for a family sofa that suits your family.

NORSBORG
loveseat with chaise longue
\$1170

NORSBORG loveseat with chaise longue \$1170. Cover: 53% cotton, 47% polyester. RA. W231xD88/157xH85cm. Finnsta red/birch 891.249.88

24-hour comfort

Complete comfort is having a relaxing place to sit by day and sleep by night. These sofas make the most of any space, and some even have hidden storage inside.

Quickly transforms into a spacious bed, with space to store bedding under the seat.



HOLMSUND
sofa bed
\$849

HOLMSUND sofa bed \$849. Cover: 100% polyester. RA. W230×D91×H96cm. Bed size 140×200cm. Nordvalla medium grey 191.555.15 **MARYD tray table \$129.** Painted solid beech. Designer: Carina Bengs. L58×W38×H58cm. 902.927.25

New VALLENTUNA
sleeper sectional, 1 seat

\$740

Modular and multifunctional – VALLENTUNA has seat modules that convert into beds.



New VALLENTUNA
seat module with storage

\$270



New VALLENTUNA series. Designer: Fredriksson/L Löwenheim/Hilland. RA.
Seat module with storage \$270. Fixed cover: 60% polyester, 40% polyurethane. W80×D80×H45cm. Murum beige 303.294.11
Sleeper sectional, 1 seat \$740. 55% cotton, 25% polyester, 12% viscose/rayon, 8% flax. Add, remove or change functions to suit your needs, and choose covers to fit your style. Bed-size 80×200cm. Hillared green 091.501.46
VARV floor lamp with wireless charging \$129. Charges a compatible Qi-enabled smart-phone when you place it on top. Includes a USB port for non-wireless charging. Steel, plastic, 82% nylon and 18% polyurethane. RA. H169cm. White 202.807.02 VITAHULT Qi-enabled charging cases sold separately.

RA=REQUIRES ASSEMBLY

FRIHETEN corner sofa bed \$849. Stationary cover: 100% polyester. RA. L230×D151×H66cm. Bed size 140×204cm. Skiftebo dark orange 803.007.59
TINGBY side table on casters \$49. Foil and painted finish. RA. L50×W50×H45cm. 202.959.30 **SAMTID floor/reading lamp \$49.99.** Nickel-plated steel and plastic. RA. H152cm. White 902.865.69

FRIHETEN
corner sofa bed

\$849



Store bedding in the easy-access storage space under the chaise longue.

SOLSTA
sofa bed
\$229



SOLSTA sofa bed \$229. Stationary cover: 100% cotton. RA. W137×D78×H72cm. Bed size 118×205cm. Ransta dark grey 700.871.08

LYCKSELE LÖVÅS
sofa bed

\$319



LYCKSELE LÖVÅS sofa bed \$319. Cover: 100% polyester. RA. W142×D100×H87cm. Bed size 140×188cm. Vallarum yellow 191.499.06

Delivery service. We can bring your purchases to your home or business. Prices from \$79. See page 309.

Our passion is to make things better. However, we don't just innovate for the sake of innovation. We innovate towards a brighter future. Which sometimes also results in asking unusual questions. Like, could we make furniture out of the same material used to make an egg carton? Or, can recycled, low cost paper pulp have a role beyond product packaging? Actually, that's exactly what we asked ourselves, and so the exploration of paper-made furniture began. Yes really, paper.

Furniture made out of paper. Really?

▼ Dive deeper into our features by downloading the IKEA Catalogue app.

From one country to the next, an IKEA design team travelled around the world to visit factories and suppliers for fresh inspiration and knowledge. The road from idea to prototype is not always a straightforward one – the entire paper industry is built upon deeply rooted traditions. “They think you're a little crazy – what you might think is beautiful, somebody else will

say is impossible. It's really important to stay curious,” Designer, Hanna Dalrot smiles. The team describes it as a highly collaborative process: “One thing is for sure: they understand the value of paper and its ability to be renewed. They know that there's a worth to the things that people dispose of.”, Michael Nikolic, Creative Leader explains. >>



Above | Creative Leader, Michael Nikolic, holding items traditionally known in the paper industry, like the egg carton – where the innovation and journey for IKEA really began.

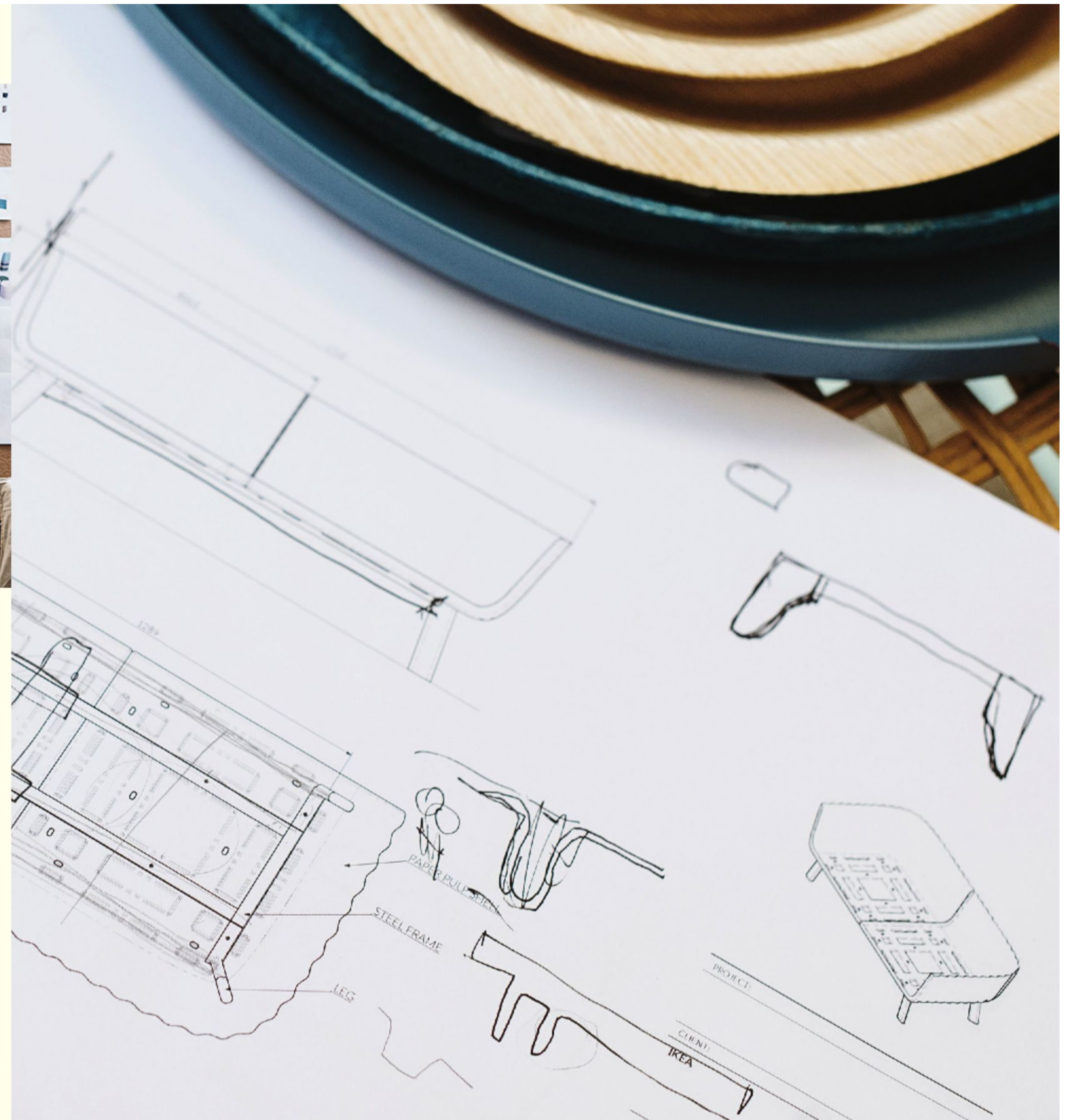

Staying environmentally conscious was the focal point for the design team. “The paper industry takes care of a lot of waste. So we thought, instead of producing packaging, which is eventually thrown away, recycled or re-produced into a new package, why not create something aesthetic out of this? That’s when IKEA is at its best – when we do things differently” Nikolic continues. Today, nine different materials have been chosen; paper being the base of it all. “It’s a wonderful material and there are multiple ways to apply it, but even so, it’s also quite complex.”

Paper pulp, one of the team’s main discoveries, is basically recyclable paper turned into a pulp and placed into a mould. Once moulded, it becomes a hard shell based on the choice of thickness and design. This process works similarly to the way other tradi-

tional materials are cast or moulded, such as ceramic, plastic or metal. But it’s paper. The lengths of its fibres, together with the amount of glue, determine the hardness and quality of the final product. Other additives can create additional attributes, like making it water-repellant or giving it a colour. In the end, the team strived to develop structural and stylish products that can also be decomposed. Designer Maja Ganszyniec refers to her father, who recently threw away his old sofa: “It took him almost two days to sort the materials for recycling. Who has two days to dismantle a sofa? No one. So most of us will just chuck the whole thing away, and that’s not good for the environment. That’s why it’s important for us to design these products in a way that’s easy for you to take them apart and separate the materials once the lifetime of the product

“We work towards making something better in the future. For me it’s about impacting people’s lives for the better, and hopefully solving new problems along the way. Although we aren’t there yet, the best is yet to come.”

Michael Nikolic, Creative Leader



Below | Designer Hanna Dalrot found that working with paper had many unimaginable possibilities. Moulding these different coloured plant pots was just one of many.



Right | Creative Leader, Michael Nikolic, together with designers Hanna Dalrot and Maja Ganszyniec in their “paper space” at the IKEA headquarters.

has run out. Only then can you properly recycle it. A paper sofa follows this logic. It’s not about the paper itself, it’s about people being conscious buyers. I think IKEA has a responsibility to create products that are speakers of this. There’s this magic moment when you come to a factory and they resist change at first, and then after a while get very excited and involved. That’s when the magic happens.”

Paper pulp, paper clay, paper glue, paper cotton and washable paper – the possibilities feel endless! These applications of paper are consistently being tested and developed into something we’d normally expect to be turned into a magazine, a milk carton, or yet another package. With a ton of ideas, tests and discoveries yet to be made, one big question still remains: will there be IKEA furniture made out of paper? The answer: the best is yet to come. No one knows quite yet how it will end. “Since it’s such a new way of working with this material, and has never been done at this scale of production before, it’s a very daring project. It depends on so many different details – the composition of the material, the thickness, and the construction of the shell. We have to regulate three or four aspects at the same time. So of course it’s a journey.” Maja says. So at IKEA, staying relentlessly curious can in fact be a good thing. If we stop questioning our approach or products, we only keep creating what’s already been done. We always want to aim for something original, something conscious, something bold – something better for you – like furniture, made out of paper. ■



“I prefer to keep the imperfections of handicraft visible. So even though a product is mass-produced I think it’s beautiful that not each and every one will look the same, or have the same exact shade of colour.”

Hanna Dalrot, Designer



Your seat, your style

It always feels good to kick back in the comfort of your own style. Alone or together.

An IKEA favourite from 1951 redesigned for today. Relax in comfort with the high, curved back.

STRANDMON
wing chair
\$399

STRANDMON wing chair \$399. Stationary cover: 100% polyester. RA. W82xD96xH101cm. Skiftebo green 303.056.17

JENNYLUND armchair \$279. Cover: 100% cotton. RA. W78xD85xH84cm. Videslund multicolour 691.295.81

JENNYLUND
armchair
\$279

TULLSTA
armchair
\$199

TULLSTA armchair \$199. Cover: 100% polyester. RA. W80xD70xH77cm. Nordvalla medium grey 591.295.29

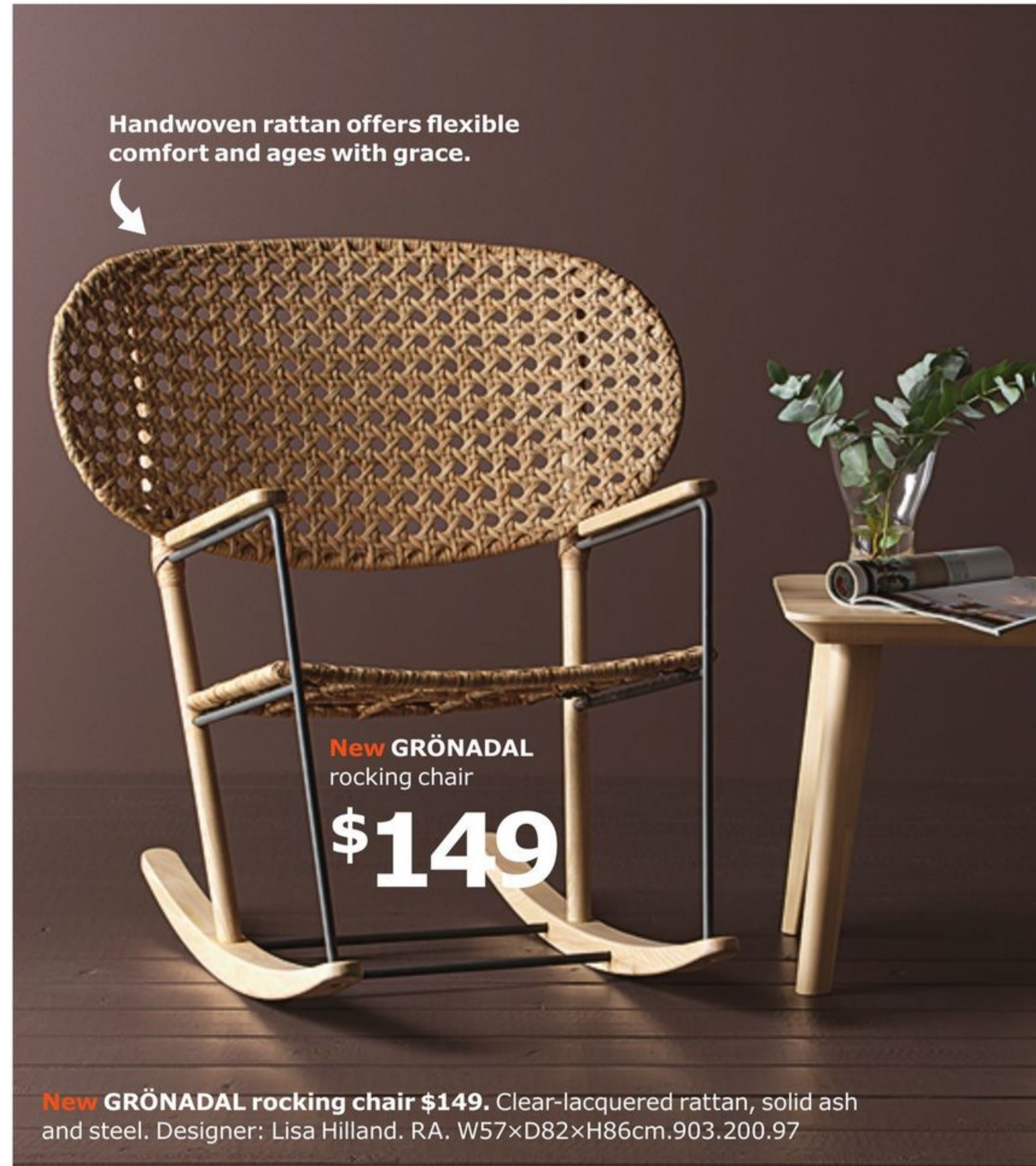

Handwoven rattan offers flexible comfort and ages with grace.

New GRÖNADAL
rocking chair
\$149

New GRÖNADAL rocking chair \$149. Clear-lacquered rattan, solid ash and steel. Designer: Lisa Hilland. RA. W57xD82xH86cm.903.200.97

EKERÖ
armchair
\$229



EKERÖ armchair \$229. Attached cover: 100% polyester. Designer: Eva Lilja Löwenhielm. RA. W70xD73xH75cm. Skiftebo orange 902.628.89

BOSNÄS
footstool with storage
\$29⁹⁹



BOSNÄS footstool with storage \$29.99. Cover: 100% cotton. L36xW36xH36cm. 602.634.75

EKENÄS
armchair
\$349



EKENÄS armchair \$349. Stationary cover: 77% polyester, 23% viscose/Rayon Designer: Ola Wihlborg. RA. W86xD78xH90cm. Hensta dark brown 802.766.55

NOLMYRA
easy chair
\$49



NOLMYRA chair \$49. Clear lacquered birch veneer and polyester. Designer: Jooyeon Lee. RA. W64xD75xH75cm. 102.335.32

PÖÄNG
armchair
\$299



PÖÄNG comes in two sizes — so everyone in the family can have their own.



PÖÄNG series. Designer: Noboru Nakamura. RA. **Armchair \$299.** Cover: through dyed grain leather. W68xD82xH100cm. Birch veneer/Seglora natural 991.814.93 **Children's armchair \$39.99.** Clear lacquered birch veneer. Cover: 100% cotton. W47xD60xH69cm. Birch veneer/Almå's Natural 101.165.52

RA=REQUIRES ASSEMBLY

A sofa's best friend

A sturdy place for setting down food and drinks, plus everything else that happens around the sofa. Board games, trains and a little crafting, perhaps?



You can put treasured items on display under the glass top.

LIATORP
coffee table
\$249

LIATORP coffee table \$249. Painted finish and tempered glass. Designer: Carina Bengs. RA. L93×W93×H51cm. 500.870.72

SVALSTA nesting tables, set of 2 \$99.
Sizes: 1 pc L73×W63×H45cm and 1 pc L55×W45×H40cm. Stained, clear lacquered ash veneer. RA. 602.806.77

SVALSTA
nesting tables,
set of 2
\$99



SANDHAUG
tray table
\$99/ea

Three functions in one – a side table, serving tray and storage.

SANDHAUG tray table \$99/ea. Rattan and powder-coated steel. Designer: D Wahl/A Fredriksson. Ø63, H45cm. 402.972.59

HEMNES
console table

\$179

HEMNES sofa table \$179. Stained, clear lacquered solid pine. Designer: Carina Bengs. RA. L157×W40×H74cm. 203.296.28 Baskets are sold separately.



LINDVED
side table
\$19⁹⁹

LINDVED side table \$19.99. Powder-coated steel. Designer: Ehlén Johansson. RA. Ø50, H68cm. 301.256.97



KRAGSTA
coffee table
\$129

KRAGSTA coffee table \$129. Painted finish. Designer: Carina Bengs. RA. Ø90, H48cm. 202.866.38

LACK series. Painted finish. RA. L55×W55×H45cm.
01 Side table \$9.99. White 200.114.13
02 Side table \$12.99. Yellow 103.242.78

01 LACK
side table, white
\$9⁹⁹

RISSNA
coffee table
\$149

RISSNA coffee table \$149. Painted finish and stained, clear lacquered solid beech. Designer: Ola Wihlborg. RA. L160×W55×H40cm. 002.972.42

Each solid birch leg has only one fitting, making this ash veneer table easier to assemble. So you can enjoy the warm, natural feeling of LISABO just minutes after you bring it home.

01 LISABO
side table
\$99

01–02 LISABO series. Clear lacquered ash veneer and solid birch. RA. Designer: K Hagberg/M Hagberg. **01 Side table \$99.** L45×W45×H45cm. 102.976.56 **02 Coffee table \$149.** L70×W70×H50cm. 902.976.57

RA=REQUIRES ASSEMBLY



MALMSTA
coffee table
\$199

MALMSTA coffee table \$199. Stained, clear lacquered ash veneer and tempered glass. Designer: Ebba Strandmark. RA. L130×W80×H52cm. 602.611.84

Feels like home

Rugs, cushions, throws and curtains transform every room into a place that feels just right to you. Instantly add warmth, softness and your personal style. So you can feel relaxed and welcomed every time you walk in the door.

New VÄRSTJÄRNA
throw
\$14⁹⁹/ea



New VÄRSTJÄRNA throw
\$14.99/ea. 100% polyester.
Designer: Synnöve Mork.
W130xL180cm.
Multicolour 403.202.12

01 New GÖRLÖSE rug, low pile **\$29.99.** 100% polypropylene.
Designer: S Edholm/L Ullenius. 4' 4" x 6' 5" (W133xL195cm) 503.208.48
02 New PANDRUP rug, low pile **\$59.99.** 100% polypropylene.
Designer: S Edholm/L Ullenius. 4' 4" x 6' 5" (W133xL195cm) 103.208.50



01 New GÖRLÖSE
rug, low pile
\$29⁹⁹

02

You can make it yourself
with **IKEA metre fabric**. Find
sewing tips at IKEA.ca

New MATTRAM
fabric
\$5⁹⁹/m



New MATTRAM fabric \$5.99/m. 100% cotton.
Designer: Niina Aalto. W150cm.
Orange 003.200.25

Layer with a block-out roller
blind to control exactly how
much light comes in.

New MATTRAM
curtains, 1 pair
\$29⁹⁹

New MATTRAM curtains, 1
pair **\$29.99.** 65% polyester, 35%
cotton. Designer: Niina Aalto.
W145xL250cm/per panel.
Black/white 803.210.78
TUPPLUR block-out roller
blind **\$34.99.** Powder coat-
ing, polyester. W48xL76¼". RA.
003.091.17



Add a big boost of softness

New
\$6⁹⁹/ea



01

02

03

It may be one of the oldest tricks in the book, but it's still great. When it comes to refreshing a room nothing compares to a nice soft colourful cushion. Or two. Or three.

01 New PENNINGGRÄS cushion **\$6.99.**
Designer: S Edholm/L Ullenius. 803.210.16
02 New MATTRAM cushion **\$6.99.**
Designer: Niina Aalto. 503.209.52
03 New HÖSTFIBBLA cushion **\$6.99.**
Designer: S Edholm/L Ullenius. 903.210.11



- 01 SANELA curtains, 1 pair \$79.99.**
100% cotton velvet. W140xL250cm/per panel. 802.301.96
- 02 New KLIPPÖRT cushion cover \$5.99/ea.**
74% cotton, 26% polyester. Designer: J Booy/K Booy. L50xW50cm. 803.200.31
- 03 New STRANDKÅL cushion cover \$9.99.**
100% polyester. L40xW65cm. 403.210.37
- 04 GURLI throw \$14.99.** 70% acrylic, 30% polyester. W120xL180cm.003.261.07
- 05 SANELA cushion cover \$9.99/ea.**
100% cotton velvet. L50xW50cm. 003.266.97
- 06 New BIRKET rug, high pile \$199.**
100% polypropylene. 6' 7" x 6' 7" (W200xL200cm) 103.220.62

01 SANELA
curtains, 1 pair
\$79⁹⁹

03 New STRANDKÅL
cushion cover
\$9⁹⁹

05 SANELA
cushion cover
\$9⁹⁹/ea



Hayley
Textiles manager, Australia

When you use several layers to cover your window, you get much more control over how much light you let in, how much heat goes in or out and the level of privacy you want. You can also combine a few different fabrics, textures and colours to create a beautiful effect that truly reflects your personality.

The air inside the honeycomb structure creates a layer of insulation to help reduce heating costs.



HOPPVALS
cellular blind
\$44⁹⁹

HOPPVALS cellular blind \$44.99. Non-woven polyester fabric. RA. W38xL64". Beige 503.191.09



New BIRKET
fabric
\$5⁹⁹/m

New BIRKET fabric \$5.99/m. 100% cotton. W150cm. 203.200.34



We've removed all hanging cords from our blinds and curtains so they're safer for children.

New SKOGSKLÖVER
roller blind
\$44⁹⁹

New SKOGSKLÖVER roller blind \$44.99. Fabric: 83% polyester and 17% nylon. Rails: Aluminum. Designer: David Wahl. RA. W38xL76¾". 303.146.12



01 PRAKTLILJA
block-out curtains,
1 pair
\$69⁹⁹

01 PRAKTLILJA block-out curtains, 1 pair \$69.99. 100% polyester. W145xL250cm/per panel. 603.086.19
02 VIVAN curtains, 1 pair \$14.99. 70% polyester, 30% cotton. W145xL250cm/per panel. 602.975.69

01 AINA curtains, 1 pair \$69⁹⁹

01 AINA curtains, 1 pair \$69.99. 100% linen. W145xL250cm/per panel. 902.809.11
 02 VIGDIS cushion cover \$9.99/ea. 100% ramie. L50xW50cm. 703.170.29
 03 New KUDDVIVA cushion cover \$12.99/ea. 100% cotton. Designer: Synnöve Mork. L40xW65cm. 003.265.03
 04 New RÖDARV cushion \$29.99. Fabric: 100% cotton. Filling: Down/feathers. Designer: Eva Lundgreen. L40xW65cm. L40xW65cm. 303.349.12
 05 URSULA throw \$39.99 100% cotton. W120xL180cm. 302.006.96
 06 New RENREPE cushion cover \$5.99/ea. 100% cotton. Designer: Paulin Machado. L50xW50cm. 303.265.06
 07 New KATTRUP rug, flatwoven \$299/ea. 100% wool. 5'7"x7'10" (W170xL240cm) 303.340.35

Flip this cushion for a new look – there's a different design on the back.

06

03 New KUDDVIVA cushion cover \$12⁹⁹/ea

04

05 URSULA throw \$39⁹⁹

06 New RENREPE cushion cover \$5⁹⁹/ea

This handwoven wool rug is naturally durable and stain-resistant, and you can turn it over to make it last longer.

07



A new, easier way to hang curtains – all that's needed is an Allen key and a few clicks.

New VIDGA single track rail \$13

New VIDGA single track rail \$13. Aluminum and plastic. Designer: David Wahl. RA. L55". (140cm). 702.991.53
 HUGAD curtain rod \$4.99. Powder-coated steel. L47-83". (120-210cm). 102.171.41

New KUNGSLILJA curtains with tie-backs, 1 pair \$69.99. 44% cotton, 56% ramie. W145xL250cm/per panel. 003.129.02



New KUNGSLILJA curtains with tie-backs, 1 pair \$69⁹⁹



PÄRLBLAD curtains, 1 pair \$39⁹⁹

PÄRLBLAD curtains, 1 pair \$39.99. 100% cotton. W145xL250cm/per panel. 803.128.99

01 New REMVALLEN cushion cover \$14⁹⁹

01 New REMVALLEN cushion cover \$14.99. 80% cotton, 20% polyester. L40xW65cm. 603.210.41
 02 DAGGVIDE cushion cover \$8.99. 100% cotton. L50xW50cm. 303.147.49
 03 New LÖVKOJA cushion cover \$6.99. 100% cotton. L50xW50cm. 203.125.19



01 New SJÖSLEV rug, flatwoven \$79.99.

97% jute, 3% wool. Designer: Paulin Machado.

4' 4" x 6' 5" (W133xL195cm) 602.852.60

02 New TILST rug, flatwoven \$39.99/ea.

100% jute. Designer: Paulin Machado.

2' 4" x 5' 5" (W70xL160cm) 202.852.62

03 New SATTRUP rug, flatwoven \$169.

79% jute, 21% sisal. Designer: Paulin Machado.

5' 11" x 7' 4" (W180xL224cm) 002.852.58

04 New TERNSLEV rug, flatwoven \$249.

100% jute. Designer: Paulin Machado. 8' 2" x 8' 2"

(W250xL250cm) 402.852.56

01 New SJÖSLEV rug, flatwoven

\$79⁹⁹

Handwoven in jute, which is grown organically and is 100% recyclable.

02 New TILST rug, flatwoven

\$39⁹⁹ /ea

03

Naturally hard-wearing and stain-resistant because it's made of sisal.

04

New ROSKILDE rug, flatwoven \$149. 100% polypropylene. Designer: Synnöve Mork. 6' 7" x 8' 2" (W200xL250cm) 603.221.06

The flat-woven surface is resilient and easy to clean. Perfect under a dining table – indoors or out.

New ROSKILDE rug, flatwoven

\$149

HULSIG rug, low pile \$17.99

HULSIG rug, low pile \$17.99. User surface: 100% polypropylene. Backing: latex. Designer: Synnöve Mork. 3' 11" x 5' 11" (W120xL180cm) 102.502.01

VALLÖBY rug, low pile \$69.99

VALLÖBY rug, low pile \$69.99. 100% polypropylene. 4' 4" x 6' 5" (W133xL195cm) 803.074.83

Made to withstand rain, sun and dirt, so you can use it outside, too.

MORUM rug, flatwoven \$44.99

MORUM rug, flatwoven \$44.99. Surface: 100% polypropylene. Backing: synthetic latex. 2' 7" x 6' 7" (W80xL200cm) 602.035.80

STOCKHOLM rug, low pile \$299. Surface: 100% pure new wool. Warp: 100% cotton. Designer: Maria Vinka. 5' 7" x 7' 10" (W170xL240cm) 702.290.37

STOCKHOLM rug, low pile \$299

Made of pure new wool, so it's naturally durable and soil-resistant, and it dampens sound, too.

ADUM rug, high pile \$59.99

ADUM rug, high pile \$59.99. 100% polypropylene. 04' 3" (130cm) 103.194.89

Stubbornness is a virtue

Tell a small child not to smile, and it's one of the surest ways to inspire a toothy grin. Tell an IKEA co-worker who studied weaving and textile technology that he's not capable of weaving a rug on an old Punja loom, and he'll never stop trying to completely re-engineer it so he, and many others, easily can.

▼ Dive deeper into our features by downloading the IKEA Catalogue app.



That's the short version of what happened when Pankaj Date, a business developer at IKEA India, was asked to accompany the team to tour an IKEA supplier's rug weaving centre. Curious about the unique type of hand-weaving done on the Punja loom, he asked the weavers if he could take a seat and try it.

"I remember sitting on that loom trying to weave, and I couldn't do it. It was odd. Within 10 minutes, I started sweating. I felt frustrated that I was unable to do even basic weaving despite having all the knowledge," Pankaj said. "I blamed the loom for my failure – the seating arrangement wasn't right, or I couldn't move, or the seat height was not OK and gave me back pain."

This experience, combined with a serious case of IKEA stubbornness, fueled a two-year quest by Pankaj to improve and modernize the loom. His work paralleled

IKEA's initiative to nurture India's 300-year-old craft of hand-weaving by creating consolidated weaving centres with fair wages, good working conditions and stable work. Pankaj quickly realized that the two missions were dependent on each other – better wages could only come from more efficient production, which a redesigned loom could make possible. Add to that the fact that new workers were rather uninspired to work on the existing loom because it was difficult to operate, especially for women, and Pankaj felt there was only one course of action.

"The Punja loom has to change," he recalls thinking. But it was easier said than done. There is no large-scale, professional industry for manufacturing handlooms, he explained. They're manually operated contraptions often pieced together as makeshift framing by local contractors in rural India. >>

Right | The edge binding of the rug is made by hand.



Machine manufacturers weren't interested in the project. So, to create a model himself, Pankaj traveled on bumpy, washed-out rural roads for hours visiting automobile repair shops for spare parts with the supplier's civil and electrical engineers, often having to overcome language issues with different Indian dialects. On one visit, the local auto mechanic near the factory was unable to finish a task on time because he had no power for days.

"At every moment, I was on the verge of breaking down and thinking this wasn't going to happen because of time constraints and resource scarcity," he said. "But my manager told me, 'Keep trying. I believe in you and your logic.'"

After many months, Pankaj, with support from fellow co-workers including manufacturing specialist Deep Saluja and quality developer Sabarinath P, created four small-scale models. One of these was fabricated and made into three prototype machines that would be tested by weavers for two months. Then his next hurdle: What if the weavers didn't want to work on it?

At first they didn't, he said. They hesitated to try this strange new "machine." But slowly the perception changed.

"At every moment, I was on the verge of breaking down and thinking this wasn't going to happen. But my manager told me, 'Keep trying. I believe in your logic.'"

Pankaj Date

Weavers were happy to work on it and said they felt less tired at the end of the day. With higher comfort came a feeling of pride and prestige. The redesigned loom also doubled production.

Today, nearly 600 of the new punja looms are being used in India and Bangladesh, enabling the weaving centres to hire more people, including a high percentage of women. By 2017, 3,500 looms will be in operation and the benefits will be felt by many more weavers in more communities. In fact, the impact could get even bigger – IKEA made the decision to not patent protect the loom so it would be available for others in the rug industry to use.

Pankaj feels a big sense of satisfaction that he played a role in preserving and developing the craft of hand-weaving, making a positive impact on people's livelihoods, and creating a sustainable solution for IKEA...

...and that he is finally able to weave on a punja loom. ■



Above | This is the Punja, which in Hindi means hand. A traditional tool to stomp down the weft. Sometimes still used, but now only to do small adjustments.



Above | The rugs have been burnt, washed, dried and stretched before the workers are able to roll them up.



Below | A woman weaver working on the new Punja loom.



Right | After the rugs are washed they're hung out to dry in the sun.

A selection of hand made IKEA rugs



RASKMÖLLE rug, flatwoven \$199. Surface: 100% pure new wool. Warp: 100% cotton. 5'7"×7'10" (W170×L240cm). 003.146.56



STOCKHOLM rug, flatwoven \$349. Surface: 100% pure new wool. Warp: 100% cotton. Designer: Kazuyo Nomura. 8'2"×11'6" (W250×L350cm). 902.394.22



ALVINE rug, flatwoven \$299. Surface: 100% pure new wool. Warp: 100% cotton. 5' 7"×7' 10" (W170×L240cm). 403.146.78

Love your view

Every wall is a blank canvas for making your home more personal. Some artwork, a few framed memories or a collage of favourite objects. It's a gallery just for you.

POFFARE wall clock \$19.99. Plastic and glass. Designer: Maria Baliova. W24xH27cm. 802.870.84

Can hang on a wall or over a door, or stand on a surface with handy storage space.

POFFARE
wall clock
\$19.99



TOLSBY
frame for 2 pictures
\$1.49

TOLSBY frame for 2 pictures \$1.49. Art card is sold separately. Plastic. Designer: Henrik Preutz. Picture W10xH15cm. White 301.510.35



New MANTEBO
picture, Taxi in New York
\$59.99

New MANTEBO picture \$59.99. Plastic and chrome-plated steel. W70xH50cm. Taxi in New York 503.191.66
New KOPPARFALL picture \$49.99. Aluminum and plastic. W32xH72cm. New York destinations 903.191.88

New NACKSTA
frame for 3 pictures
\$14.99



New NACKSTA frame for 3 pictures \$14.99. Art cards are sold separately. Foil finish and steel. W30cm. 103.191.73

GUNNABO frame \$19.99. Poster is sold separately. Foil finish and plastic. Designer: M Warnhammar/A Fredriksson. Picture W50xH70cm. Black 302.917.81

GUNNABO
frame
\$19.99



01 SKURAR
wall clock
\$15.99



03



04



02 New GRÖNBY
picture, set of 4.
\$59.99



A wall template is included to make it easy to hang the collage.

This board is magnetic and can hang horizontally, too.

05



01 SKURAR wall clock \$15.99. Powder-coated steel and plastic. Designer: Ehlén Johansson. Ø32cm. 903.104.18
02 New GRÖNBY picture, set of 4 \$59.99. Motif created by Lupen Grainne. Includes: 1 hanging template, 2 pictures 37x28cm, 1 picture 78x30cm and 1 picture 57x36cm. Canvas. 303.292.94
03 VIRSERUM frame \$12.99/ea. Poster is sold separately. Foil finish and glass. Picture W30xH40cm. 803.059.12
04 New SKURAR frame \$7.99/ea. Art card is sold separately. Powder-coated steel and plastic. Designer: Ehlén Johansson. Picture W13xH18cm. 503.106.27
05 New SKURAR noticeboard \$16.99. Powder-coated steel and galvanized steel. Designer: Ehlén Johansson. L24xW38cm. 103.106.29

Every moment glows

A single tiny flame has a special way of slowing everything down. To add a feeling of warmth and make all the everyday moments shine brighter.

LUGGA
scented candle
in glass
\$3⁹⁹



LUGGA scented candle in glass \$3.99. Glass and scented paraffin/vegetable wax. H7.5cm. 702.592.13

FIRANDE series. Glass. Designer: Martin Bergström. **Bowl \$24.99.** Ø35cm. 003.057.70 **Vase \$24.99.** H40cm. 902.585.47



FIRANDE
vase
\$24⁹⁹

Made by hand, so no two
are exactly the same. ↗

SLÄENDE
gift wrap roll, 3 pack.
\$6⁹⁹



SLÄENDE gift wrap roll \$6.99/3 pack. Paper. L3×W0.7m. 403.132.59 May not be available in all locations. Please check IKEA.ca for store availability.

VÄSNAS
tealight holder
79¢/ea



VÄSNAS tealight holder 79¢/ea. Glass. Designer: Ehlén Johansson. Ø6, H6cm. 602.590.96

SINNLIG
scented candle
in glass
\$1⁶⁹



SINNLIG scented candle in glass \$1.69. Glass and scented paraffin/vegetable wax. H7.5cm. 402.363.55

SKURAR
candle holder
\$1⁹⁹



SKURAR candle holder \$1.99. Powder-coated steel. Designer: Ehlén Johansson. H11cm. 602.360.43

STOCKHOLM candlestick for 3 candles
\$22.99. Stainless steel. Designer: Monika Mulder. H11cm. 103.033.94

STOCKHOLM
candlestick
for 3 candles
\$22⁹⁹



HÅRFIN
candlestick/
candleholder, set of 3
\$29⁹⁹



HÅRFIN candlestick/candleholder, set of 3 \$29.99. Includes: 3 candlesticks/candleholders (height 22, 28 and 33cm). Powder-coated steel. Designer: Katarina Andersson. 803.111.59

01 GLASIG
candle holder,
3 pack.
\$2⁹⁹



02



03

01–03 GLASIG series. Glass. Designer: J Jelinek/N Karlsson.
01 Candle holder \$2.99/3 pack. May be combined with other products from the GLASIG series. H3.5cm. 202.591.40
02 Candle dish \$1.99. May be combined with other products from the GLASIG series. L10×W10× H1.5cm. 602.591.43
03 Lantern \$9.99. The clear glass reflects and enhances the warm glow of the candle flame. For block candle max. diameter 8.5cm. Ø19, H22cm. 102.591.45



The brass-coloured metal creates a warm glow when a tealight inside is lit.

New **STILLHET** tealight holder
\$7.99/ea

New **STILLHET** tealight holder \$7.99/ea. Stainless steel. Designer: Monika Mulder. H7cm. 503.112.88



BLOMSTER candlestick, set of 3 \$19.99. Includes: 3 candlesticks (H24, 28, and 32cm). Glass and aluminum. Designer: P Amsell/B Berlin. 501.325.69

BLOMSTER candlestick, set of 3
\$19.99

Can you have too much coziness?



VÄSNAS tealight holder
79¢/ea

With the VÄSNAS tealight holder, more is all the merrier. And don't worry about them taking up space. Once you've blown out the candles, the holders can be stacked for easy and space-efficient storage.

VÄSNAS tealight holder 79¢/ea. Glass. Designer: Ehlén Johansson. Ø6, H6cm. 602.590.96
Shop online at IKEA.ca



STOCKHOLM bowl \$16.99. Was \$24.99. Stainless steel. Designer: Monika Mulder. H10cm. 603.113.39

NEW LOWER PRICE **STOCKHOLM** bowl Was \$24.99-
\$16.99



01 VÄRVIND vase, H40cm
\$26.99

01-02 VÄRVIND series. Glass. Designer: Monika Mulder.
01 Vase \$26.99. H40cm. 403.112.84
02 Vase \$18.99. H30cm. 603.112.83



VASEN vase
\$1.99

VASEN vase \$1.99. Glass. Designer: Åsa Gray. H20cm. 000.171.33

Everything has its space

Stand-alone units and modular cabinets make it easy to add the storage space you need – and make the most of the space you have, too.

Rubber underneath every shelf dampens the sound, giving this lightweight shelving unit a solid feel.

New DRAGET shelving unit
\$39⁹⁹

New DRAGET shelving unit
 \$39.99. Powder-coated steel. RA. W60×D30×H140cm. 203.286.81

BILLY bookcase
\$237

BILLY bookcase \$237. Stained ash veneer. RA. W240×D28×H106cm. Brown 291.564.06

BESTÅ storage combination w/glass doors \$460. Foil, painted fibreboard, and particleboard. RA. W120×D40×H192cm. White/Valviken grey-turquoise clear glass 091.386.49 Lighting sold separately.

BESTÅ storage combination with glass doors
\$460

VALJE wall cabinet
\$196

VALJE wall cabinet \$196. Foil, painted fibreboard, and particleboard. 991.721.63
LEDBERG LED spotlight, set of 3
 \$14.99. Plastic. White 802.988.22

Assembly service. We can help you to assemble your new furniture. Prices from \$79. See page 309.

Michael
 Sales responsible, Sweden

With modular storage units, you can create your own unique combinations that best fit in the space you have – even if it's an odd shape or size. And, when you move or change home in the future, you can take the modules with you and simply rearrange them or add to them to fit your new place.

01 **New LIXHULT cabinet, W25×D25×H25cm.**
\$20/ea

02 **New LIXHULT cabinet, W25×D25×H25cm.**
\$20/ea

01 **New LIXHULT series.** Powder-coated steel. Designer: Jon Karlsson. RA.
01 Cabinet \$30/ea. W35×D35×H35cm. Orange 903.286.68 Blue 103.286.67
02 Cabinet \$20/ea. W25×D25×H25cm. White 503.286.65 Yellow 303.286.66
03 Cabinet \$40/ea. W35×D35×H60cm. Green 303.286.71 Red 503.286.70
04 Cabinet \$40. W60×D35×H35cm. Grey 703.286.69

02 **Colourful, modular storage you build your way – stacked or wall-mounted, alone or together, in many sizes.**

03 **03** **04**

RA=REQUIRES ASSEMBLY



HEMNES cabinet with panel/glass door \$349. Was \$395.
Stained, clear lacquered solid pine and tempered glass.
Designer: Carina Bengs. RA. W90xD37xH197cm. 503.296.22

NEW LOWER PRICE

HEMNES cabinet with panel/glass-door
Was \$395

\$349



VITTSJÖ shelving unit
\$99

VITTSJÖ shelving unit \$99. Powder-coated steel, tempered glass and foil finish. Designer: Johan Kroon. RA. W100xD36xH175cm. 202.133.12

BRUSALI high cabinet with doors \$149. Foil finish and plastic. RA. W80xD48xH190cm. 403.022.89



BRUSALI high cabinet with doors
\$149



Sliding glass doors keep dust out and save space.

MALSJÖ glass-door cabinet
\$499

MALSJÖ glass-door cabinet \$499. Stained, clear lacquered ash veneer and tempered glass. Designer: Carina Bengs. RA. W103xD47xH141cm. 603.034.81



Get your life in order

KALLAX shelving unit
\$99⁹⁹

KALLAX takes great care of your treasured favourites. Fastened to the wall it makes sure your collection is neatly stored, in your preferred order and always within reach. Or safely out of reach, if that's what your life calls for.

KALLAX shelving unit \$99.99. Painted finish. Designer: Tord Björklund. RA. W77xD39xH147cm. 802.758.87
Shop online at IKEA.ca

RA=REQUIRES ASSEMBLY

Not just the TV

TVs go hand-in-hand with lots of other things, like remotes, sound systems and gaming equipment. Get the storage you need while making the most of all that wall space around the screen.



BRUSALI TV bench \$79. Foil finish and plastic. RA. W120xD36xH62cm. 103.022.95



FJÄLLA
box with lid, yellow

\$9.99



FJÄLLA box with lid \$9.99.

Paper and steel. RA. W27xD36xH20cm. Yellow 403.253.18

Box with lid \$6.99.

RA. W22xD27xH16cm. Off-white 502.920.01

01 HEMNES
bookcase

\$180/ea



01-03 HEMNES series. Stained, clear lacquered solid pine. Designer: Carina Bengs. RA. **01 Bookcase \$180/ea.** W90xD37x H197cm. 402.821.30
02 Wall/bridging shelf \$120. W149xD37xH34cm. 802.972.19 **03 TV Bench \$249.** W149xD47xH57cm. 702.970.45 Lighting sold separately.

Picking with Delivery service. We collect all your purchased items and deliver them to you. Prices from \$99. See page 309.



TOMNÄS TV storage unit \$299. Foil, painted fibreboard, and particleboard. RA. W183xD47.5xH162cm. Max. screen size flat screen TV 55". 003.065.81
KVARNVIK box with lid \$19.99/ea. Paper and steel. RA. L32xW35xH30cm. Grey 302.566.69

RA=REQUIRES ASSEMBLY

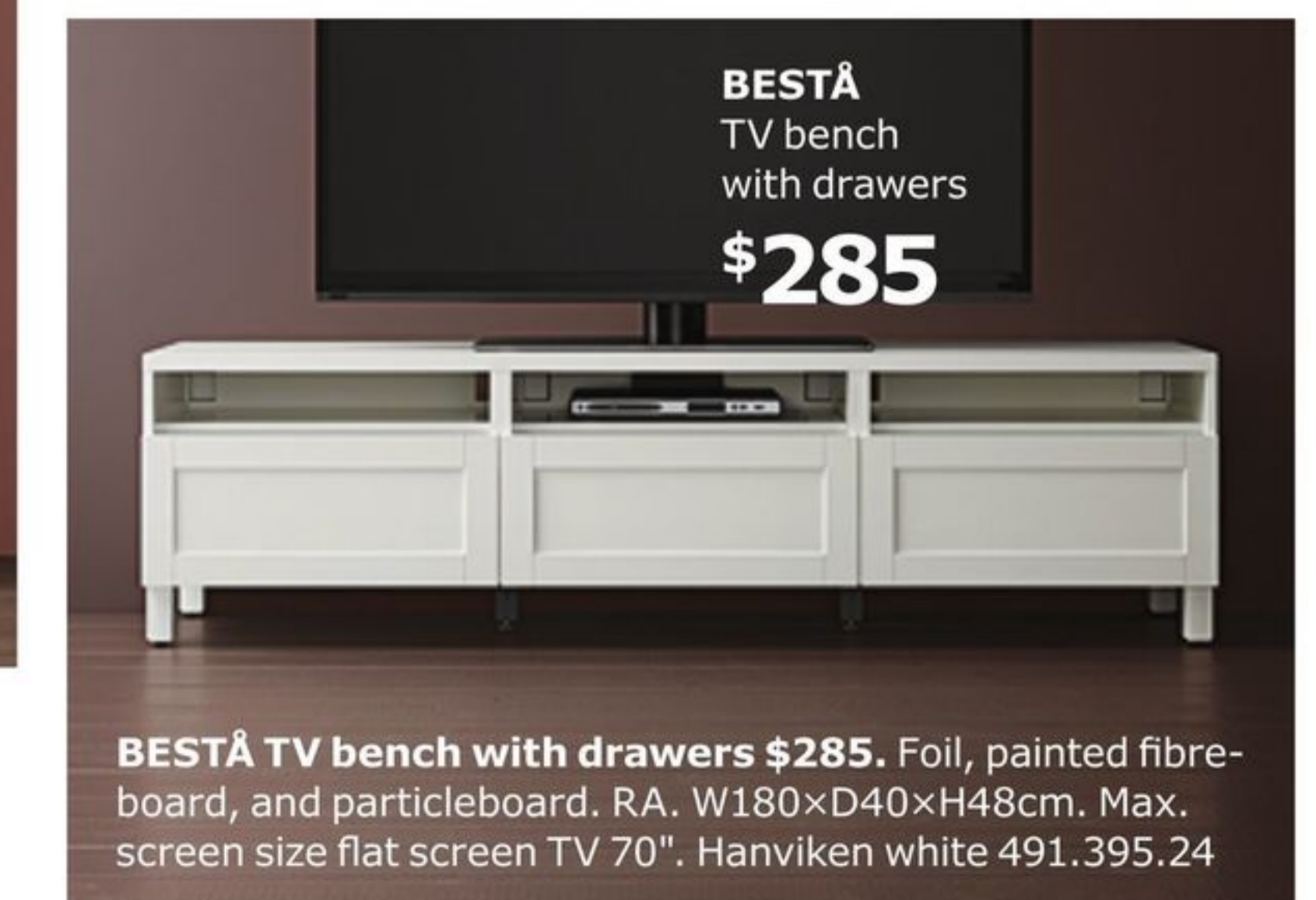



LISABO
TV bench
\$149

LISABO TV bench \$149. Clear lacquered ash veneer and solid birch. Designer: K Hagberg/M Hagberg. RA. W114xD40xH45cm.103.018.99



KUGGIS
box with lid
\$26⁹⁹

KUGGIS box with lid \$26.99. Recycled PET plastic. W37xD54xH21cm. 102.802.03



VITTSJÖ
TV bench
\$79

VITTSJÖ TV bench \$79. Powder-coated steel, tempered glass and foil finish. Designer: Johan Kroon. RA. W100xD36xH53cm. Max. screen size flat screen TV 40". 703.034.28



BYÅS
TV bench
\$149

BYÅS TV bench \$149. Painted finish. Designer: Marcus Arvonen. RA. W160xD42xH45cm. RA. 802.277.97



BESTÅ
TV bench
with drawers
\$275

BESTÅ TV bench with drawers \$275. Foil, painted fibreboard, and particleboard. RA. W120xD40xH74cm. Max. screen size flat screen TV 50". Lappviken black-brown 190.842.88

MOSTORP series. High-gloss foil finish. RA. **TV bench \$299.** W159xD46xH60cm. 002.952.57 **Wall shelf \$149.** Different wall materials require different types of fasteners. Use fasteners suitable for the walls in your home. W160xD27xH27cm. 102.957.04



MOSTORP
TV bench
\$299

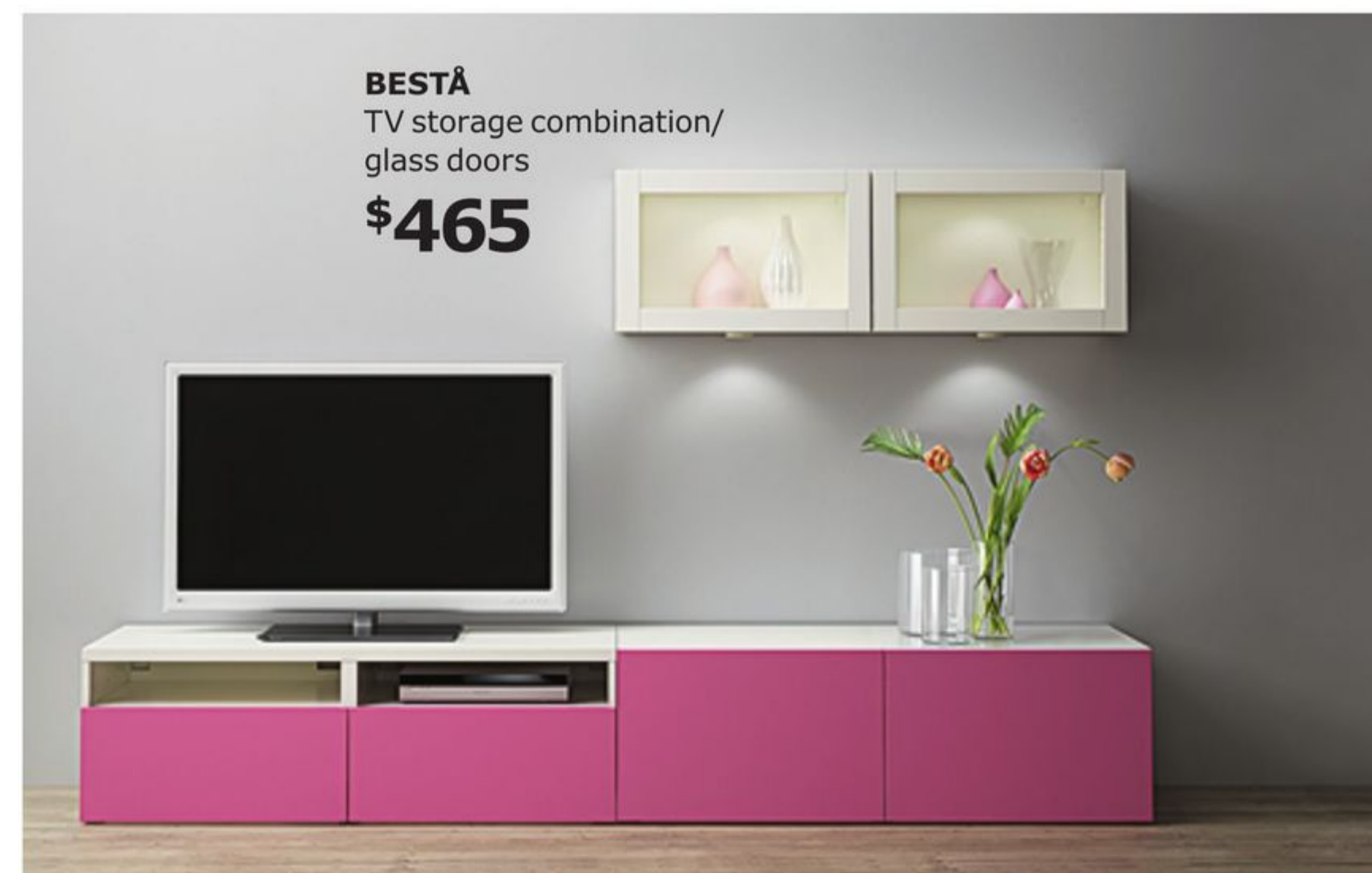

BESTÅ
TV storage combination/
glass doors
\$465

BESTÅ TV storage combination/glass doors \$465. Foil, painted fibreboard, and particleboard. Max. screen size flat screen TV 50". Lappviken pink/Sindvik white clear glass 790.711.17 Lighting sold separately.

RA=REQUIRES ASSEMBLY



LACK
TV bench
\$19⁹⁹

LACK TV bench \$19.99. Clear lacquered, printed finish. RA. W90xD26xH45cm. 902.432.97



BESTÅ
box
\$10

BESTÅ box \$10. 100% polyester. W25xD31x H15.0cm.503.098.41



Designed around your TV – with space-saving wall cabinets, hidden cables and remote control-friendly glass doors.

BESTÅ
TV storage combination/
glass doors
\$815

BESTÅ TV storage combination/glass doors \$815. Foil, painted fibreboard, and particleboard. RA. W240xD40xH230cm. Max. screen size flat screen TV 70". Grey stained walnut effect/Valviken dark brown clear glass 291.382.76 Lighting sold separately.

Picking with Delivery service. We collect all your purchased items and deliver them to you. Prices from \$99. See page 309.

Calm looks good on you

Pull-out pants hangers, see-through drawers, LED lighting, baskets and shelves all work together to take the chaos out of getting ready every day. KOMPLEMENT interior organizers make your wardrobe fit your clothes and your life.

KOMPLEMENT drawer with glass front \$50/ea. Foil finish and tempered glass. Designer: Ehlén Johansson. RA. Frame W100xD58cm. 402.467.12



URSHULT LED cabinet lighting \$25

URSHULT LED cabinet light \$25. Nickel-plated steel. Designer: Mikael Warnhammar. L29cm. 602.604.05 Complete with ANSLUTA transformer and power supply, sold separately.

KOMPLEMENT pull-out clothes rail \$20. Powder-coated steel. Designer: Ehlén Johansson. Frame W100xD35cm. 202.569.00



Easy to see and reach - simply pull out the rail to access clothes in the back.

KOMPLEMENT pull-out clothes rail \$20

KOMPLEMENT valet hanger \$5. Was \$6.99. Powder-coated steel. Designer: Ehlén Johansson. RA. W16.5xD8.5xH5cm. 602.571.82



NEW LOWER PRICE

KOMPLEMENT valet hanger \$5



KOMPLEMENT pull-out multi-use hanger \$15



STÖTTA LED lighting strip \$14.99

STÖTTA LED light strip \$14.99. Battery-operated. Plastic. Designer: David Wahl. L35cm. 202.771.39 AA batteries sold separately.

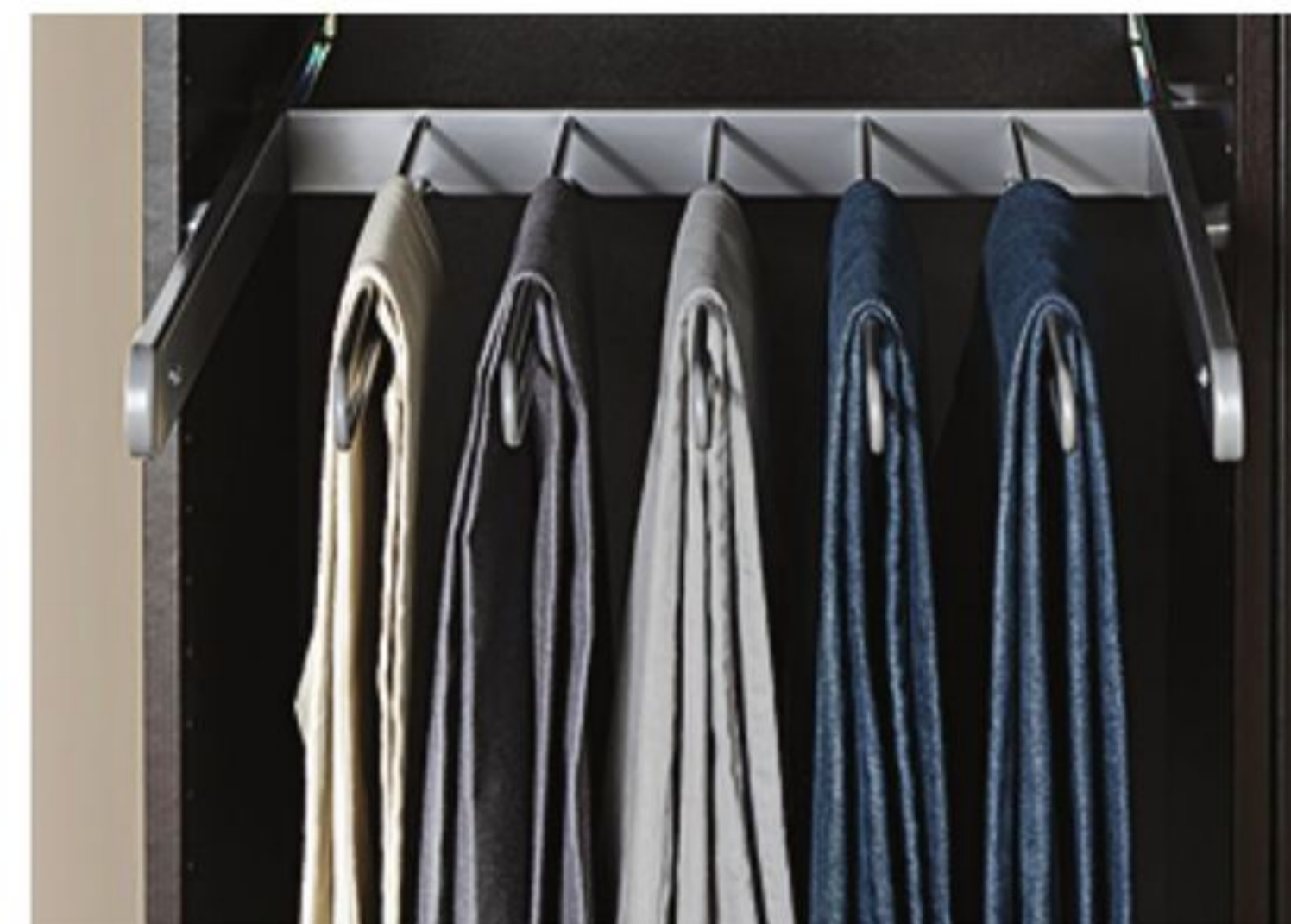

KOMPLEMENT pull-out pants hanger \$30

KOMPLEMENT pull-out pants hanger \$30. Powder-coated steel. Designer: Ehlén Johansson. Frame W50xD58cm. RA. 102.573.68

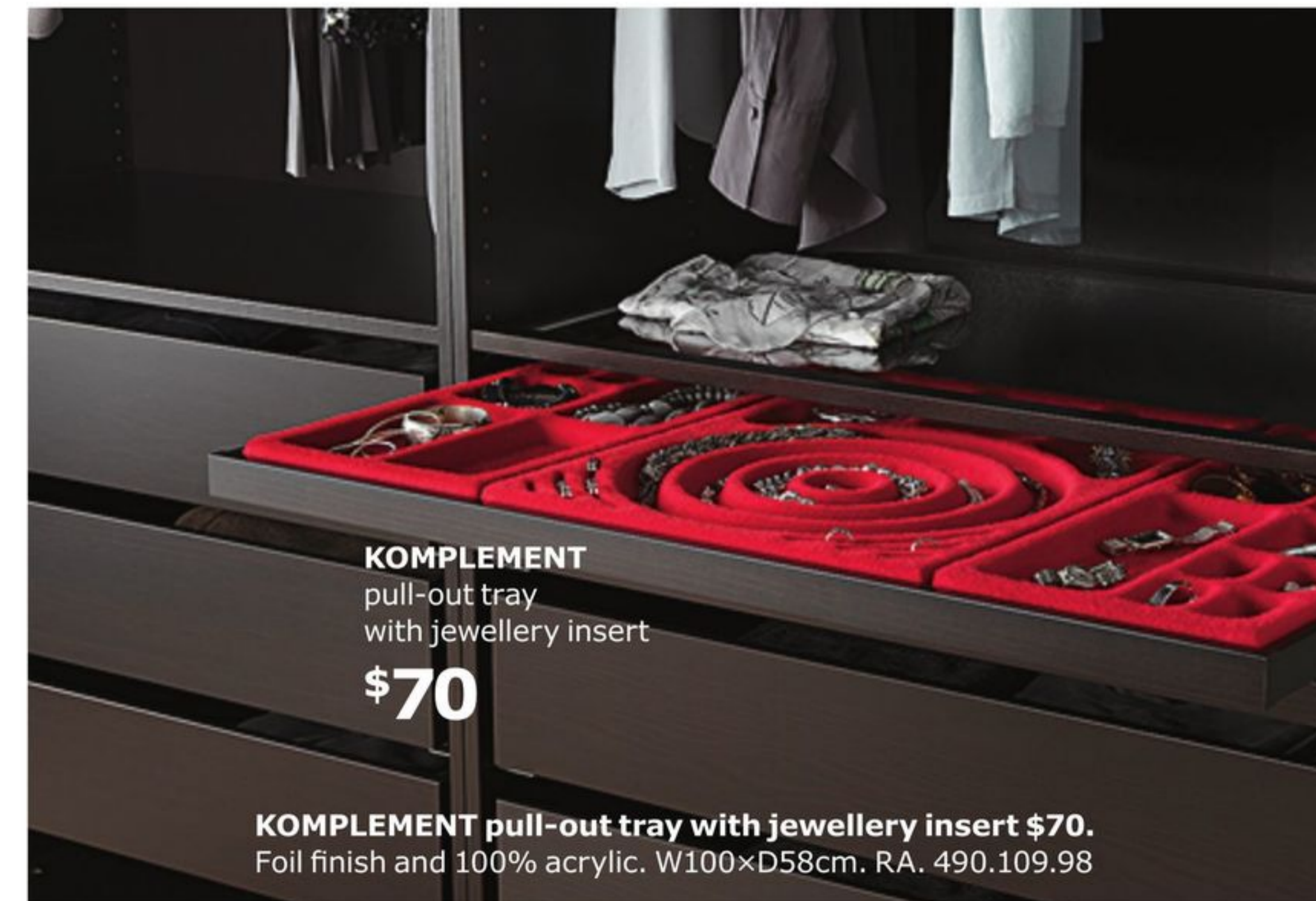

KOMPLEMENT pull-out tray with jewellery insert \$70

KOMPLEMENT pull-out tray with jewellery insert \$70. Foil finish and 100% acrylic. W100xD58cm. RA. 490.109.98



KOMPLEMENT metal basket \$30/ea

KOMPLEMENT metal basket \$30/ea. Powder-coated steel. Designer: Ehlén Johansson. Frame W50xD58cm. Pull-out rails included. 890.109.96

KOMPLEMENT pull-out multi-use hanger \$15. Powder-coated steel. D58cm. 202.624.87

RA=REQUIRES ASSEMBLY

KOMPLEMENT series.
 Designer: Ehlén Johansson.
Glass shelf \$35. Foil finish and tempered glass.
 100×58cm. 402.576.49
Pull-out tray with divider \$50.
 Foil finish and plastic. 100×58cm. 790.110.67
 KOMPLEMENT felt drawer mat sold separately.

KOMPLEMENT
 glass shelf
\$35



New PAX/FARDAL
 wardrobe

Doors and frames
\$390

Interior Organizers
\$150

Total wardrobe price
\$540

New PAX wardrobe \$540.
 Foil finish and high-gloss foil finish.
 RA. W100×D60×H236.4cm.
 Black-brown/FARDAL high-gloss/
 light green 491.589.75
KOMPLEMENT interior organizers
included in this combination:
 One shelf 100×58cm,
 one clothes rail 100cm,
 one divider for frames 50×58cm,
 four 2 pack pull-out rail for basket
 and four mesh baskets 50×58cm.
 Lighting and SKUBB boxes are sold
 separately.



PAX/NEXUS/VIKEDAL
 wardrobe

Doors and frames
\$295

Interior Organizers
\$90

Total wardrobe price
\$385

NEW LOWER PRICE
PAX wardrobe \$385.
 Was \$395.
 Foil, stained clear lacquered
 ash veneer/mirror glass. RA.
 W75×D60×H236.4cm.
 Black-brown/NEXUS black-brown/
 VIKEDAL mirror 991.613.10
KOMPLEMENT interior organizers
included in this combination:
 Three shelves 75×58cm,
 one clothes rail 75cm
 and one pull-out trouser hanger
 75×58cm.
 Lighting and SKUBB box are sold
 separately.



PAX/HASVIK
 wardrobe

Doors and frames
\$500

Interior Organizers
\$80

Total wardrobe price
\$580

NEW LOWER PRICE
PAX wardrobe with sliding doors \$580.
 Was \$600.
 Foil and painted finish. RA.
 W200×D66×H236.4cm.
 White/HASVIK white 391.279.08
KOMPLEMENT interior organizers
included in this combination:
 Four shelves 100×58cm
 and two clothes rails 100cm.
 Lighting and SKUBB boxes are sold
 separately.

RA=REQUIRES ASSEMBLY



Space for higher shoes on the bottom and lower ones on top. All are easy to reach since the entire unit pulls out.

KOMPLEMENT
pull-out shoe shelf
\$30

KOMPLEMENT pull-out shoe shelf \$30. Powder-coated steel. Designer: Ehlén Johansson. RA. W75xD58xH16.5cm. 302.574.71



PAX/BERGSBO
wardrobe

Doors and frames

\$320

Interior Organizers

\$70

Total wardrobe price

\$390

NEW LOWER PRICE **PAX wardrobe \$390.** Was \$400. Foil finish. RA. 100xD60xH236.4cm. White/BERGSBO white 391.277.10 **KOMPLEMENT interior organizers included in this combination:** Two shelves 100x58cm, one clothes rail 100cm, one 2 pack pull-out rail for basket and one mesh basket 100x58cm. Lighting and SKUBB boxes are sold separately.



PAX/UNDREDAL
wardrobe

Doors and frames

\$620

Interior Organizers

\$280

Total wardrobe price

\$900

NEW LOWER PRICE **PAX wardrobe \$900.** Was \$922. Foil and painted finish. RA. W150xD60xH236.4cm. Black-brown/UNDREDAL black 590.944.12 **KOMPLEMENT interior organizers included in this combination:** Two shelves 100x58cm, two shelves 50x58cm, one clothes rail 100cm, one clothes rail 50cm, three drawers 100x58cm, one 2 pack pull-out rail for basket, one metal basket 100x58cm, one pull-out tray 50x58cm, one pull-out trouser hanger 50x58cm and one valet hanger. Lighting and SKUBB boxes are sold separately.



PAX/BERGSFJORD
wardrobe

Doors and frames

\$580

Interior Organizers

\$230

Total wardrobe price

\$810

NEW LOWER PRICE **PAX wardrobe with sliding doors \$810.** Was \$830. Foil and painted finish. RA. W200xD66xH236.4cm. White/BERGSFJORD white 790.257.19 **KOMPLEMENT interior organizers included in this combination:** Six shelves 100x58cm, two clothes rails 100cm, four 2 pack pull-out rail for basket and four mesh baskets 100x58cm. Lighting and SKUBB boxes are sold separately.

RA=REQUIRES ASSEMBLY

Assembly service. We can help you to assemble your new furniture. Prices from \$79. See page 309.



New **ELVARLI**
storage combination
\$689

New **ELVARLI** storage
combination **\$689**.

Easily customized to suit your needs.
Lacquered aluminum.
RA. W165xD55xH216cm.
091.575.29

BRIMNES wardrobe with 3 doors **\$199**.
Foil finish and mirrored glass. Designer: K
Hagberg/M Hagberg. RA. W117xD50xH190cm.
White 702.458.53



BRIMNES
wardrobe with
3 doors
\$199



TYSSEDAL
wardrobe
\$449

TYSSEDAL wardrobe **\$449**. Painted finish and
mirror glass. Designer: Ebba Strandmark. RA.
W88xD58xH208cm. White 002.981.28

HEMNES
wardrobe with
2 sliding doors
\$369

HEMNES wardrobe with 2 sliding
doors **\$369**. Stained, clear
lacquered solid pine.
Designer: Carina Bengs. RA.
W120xD59xH197cm.
Yellow 103.213.26



BREIM
wardrobe
\$399

BREIM wardrobe **\$39.99**. 100% polyester and
powder-coated steel. Designer: K Hagberg/M Hagberg.
RA. W80xD55xH180cm. Blue 702.889.51



RIGGA
clothes rack
\$1899

RIGGA clothes rack **\$18.99**.
Powder-coated steel and plastic. RA.
W111xD51xH126-175cm. Silver
502.316.30
SKUBB series. 100% polyester and
polypropylene plastic.
Storage with 6 compartments
\$9.99. W35xD45xH125cm.
Light blue 603.239.69
Shoe box \$12.99 /4 pack.
W22xD34xH16cm.
Light blue 203.239.66



HURDAL
linen cabinet
\$399

HURDAL linen cabinet **\$399**. Stained, clear
lacquered solid pine. Designer: Francis
Cayouette. RA. W109xD50xH137cm.
Green 102.688.52

ANEBODA
wardrobe
\$99



ANEBODA wardrobe **\$99**. Foil finish and
plastic. Designer: Tord Björklund.
RA. W81xD50xH180cm. White 901.217.62

Easy to place anywhere,
even the bathroom. And
you can hang tomorrow's
outfit in back.



IKORNES
standing mirror
\$139

IKORNES standing mirror **\$139**.
Ash veneer and mirror glass. Designer: Ola
Wihlborg. RA. W52xH167cm. 302.983.96

RA=REQUIRES ASSEMBLY



Left | JOKKMOKK is a full dining set of four chairs and a table that you can bring home in a single box.

JOKKMOKK table and 4 chairs
\$169. Stained, clear lacquered solid pine. Designer: Carina Bengs. RA.
 Table L118xW74xH74cm.
 Chair W41xD47xH90cm. 502.111.04



Above | A shining example of great packaging. GLIMMA tea candles were previously sold loose in a bag. The new “brick philosophy” packaging saves time, money and transport – and they’re easier for you to carry, and to store at home.

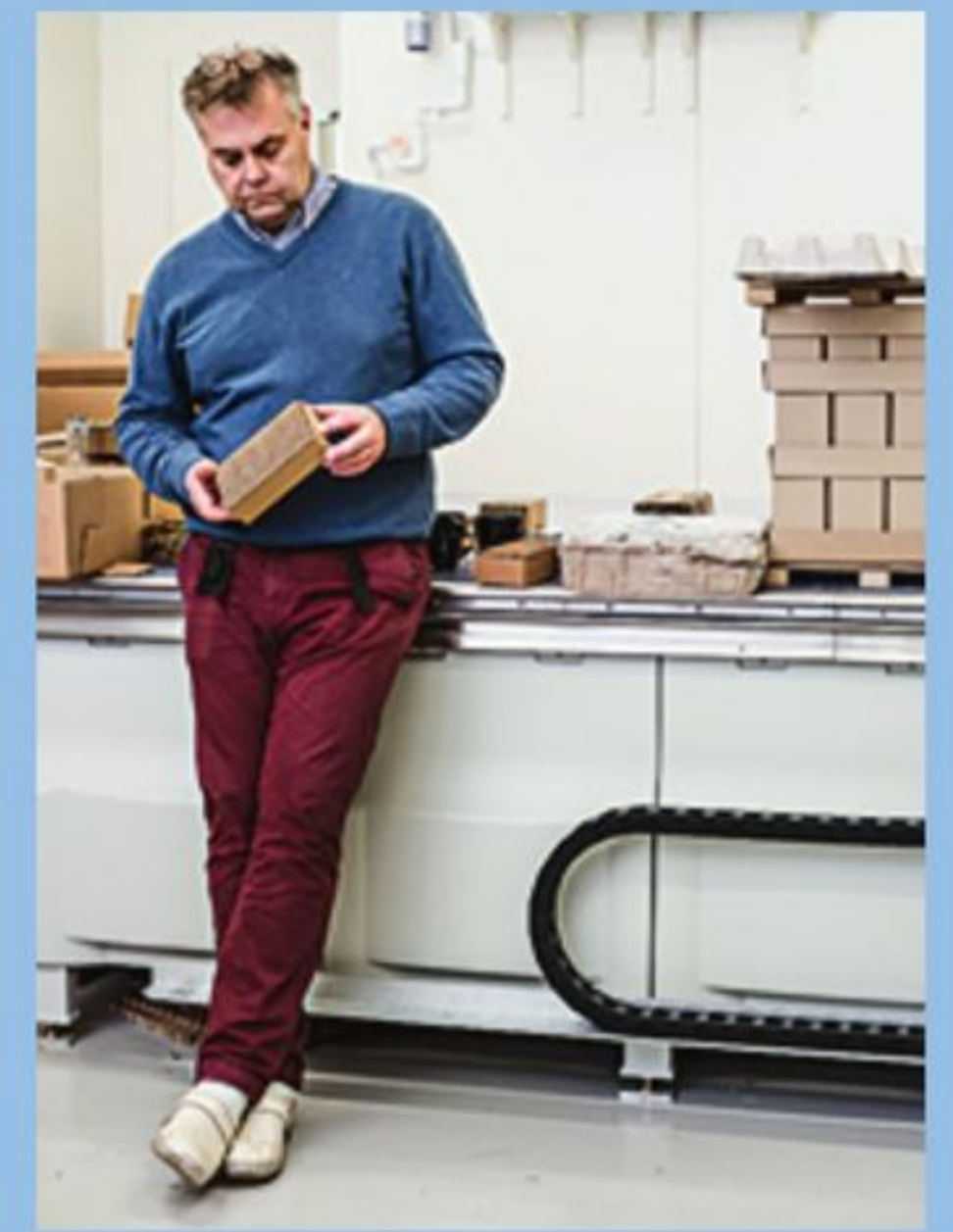
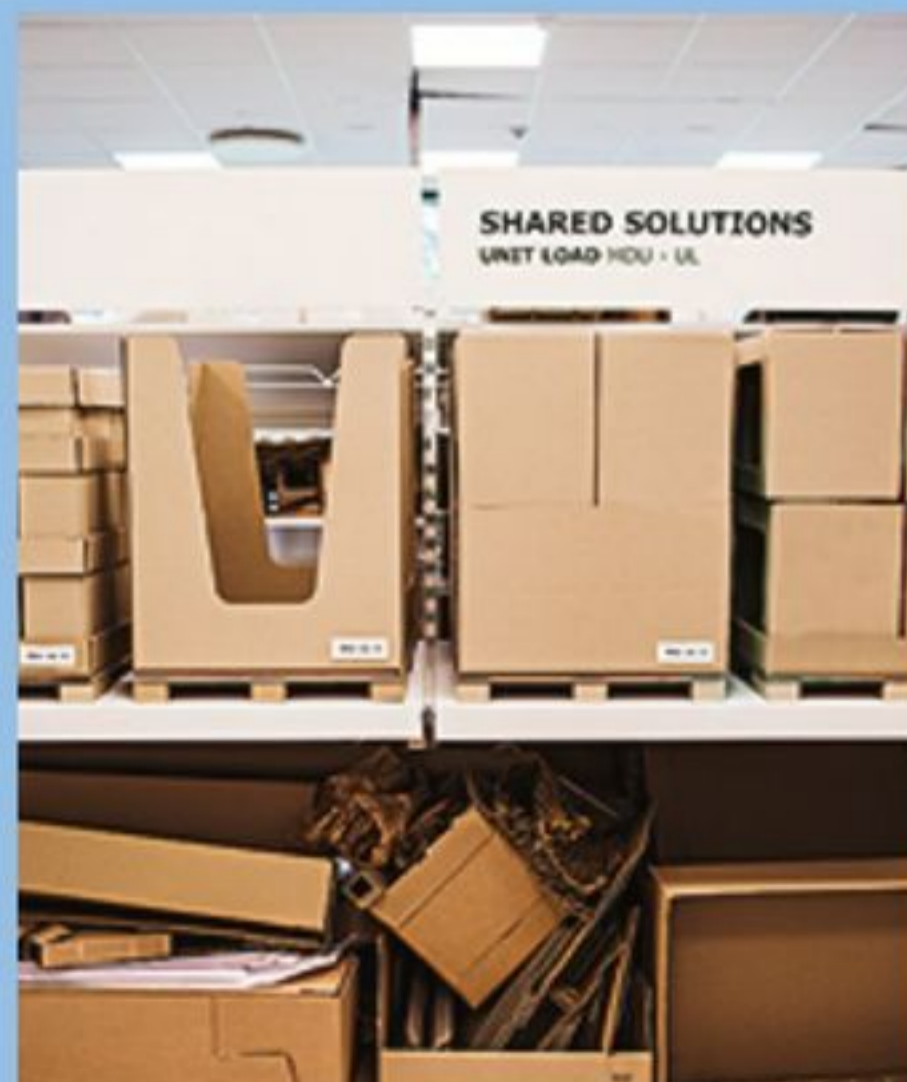

Above | Packaging is as important to us as the products that go inside. Allan Dicknéř, Deputy Packaging Development Manager, is in charge of maximizing usage and minimizing waste, every step of the way.

Thinking inside the box

Since the first flats packs came out of IKEA in the late 1950s, our packaging methods have been constantly challenged, reconsidered and developed to secure the lowest price possible, and make customer handling as smooth and easy as possible. The magic is in the details.

Our packaging philosophy relies on – or is wrapped into – a few principles: focus on the customer; packaging as part of the product; optimize cost throughout the value chain; the health and safety of our co-workers and customers; positioning the IKEA brand; and having a positive impact on people and the planet.

But how does it happen? You would be forgiven for thinking that we simply squeeze products into the smallest and flattest package possible. Not quite. The best packaging solutions are integrated into the product development process, resulting in flatter packs and even more affordable prices. Maximal usage and minimal waste is always what we’re striving for – in the actual packaging, but also in the loading of each pallet, each container and each shipment. It’s all one gigantic puzzle that needs to fit together. What we at IKEA dislike

more than anything else is shipping air.

Over the years we’ve come up with some revolutionary solutions, but there’s also been setbacks and failures. “Only the one who sleeps makes no mistakes,” says the founder of IKEA, Ingvar Kamrad. GLIMMA is a shining example of great packaging. These small and popular tea-lights were previously sold as 100 loose candles packed in a plastic bag.

Since then, we have improved the packaging step by step, saving space on our pallets and hence becoming more sustainable, and at the same time protecting the candles to ensure they reach our stores in good shape. The new and improved packaging saves 30-45 minutes per day in store handling, we can fit 108 more packages on each pallet and – listen to this – because of the large volumes we move of this product, approximately 400 fewer trucks will hit the roads with GLIMMA.

JOKKMOKK is another example of good packaging – but maybe a little too good. It seems that some people had a hard time grasping the fact that we squeezed one table and four chairs into the same flat pack. This great packaging solution became

a communication challenge in our stores.

But with EKTORP, we got it right. EKTORP was the first sofa that came knocked-down and flat-packed, which has been a huge improvement for customers because it means they can bring it home by themselves. And as a result, the majority of sofas and armchairs today are flat packaged – and this will only increase.

And that’s not all. We have stopped using expanded polystyrene in our flat packaging and replaced it with paper-based materials. We also recycle the stretch film used around our pallets, using it as a raw material for some of our products.

We constantly work to minimize the use of packaging materials and maximize the efficiency of our transportation – so we ship as little empty air as possible. The reason for all of this? We want to have a positive impact on people and the planet, which includes taking a lead in turning packaging waste into resources, and maximizing the use of renewable and recycled packaging materials. That’s at the heart of every IKEA packaging solution. ■

Drawers for everything

From art supplies in the dining room to hats in the hallway, sturdy chests of drawers bring handy, hidden storage wherever you need it.



KNAPPER standing mirror \$49.99. Mirror glass and powder-coated steel. Designer: N Cortolezzis/D Wahl. RA. W48xH160cm. 002.173.87

KNAPPER
standing mirror
\$49⁹⁹

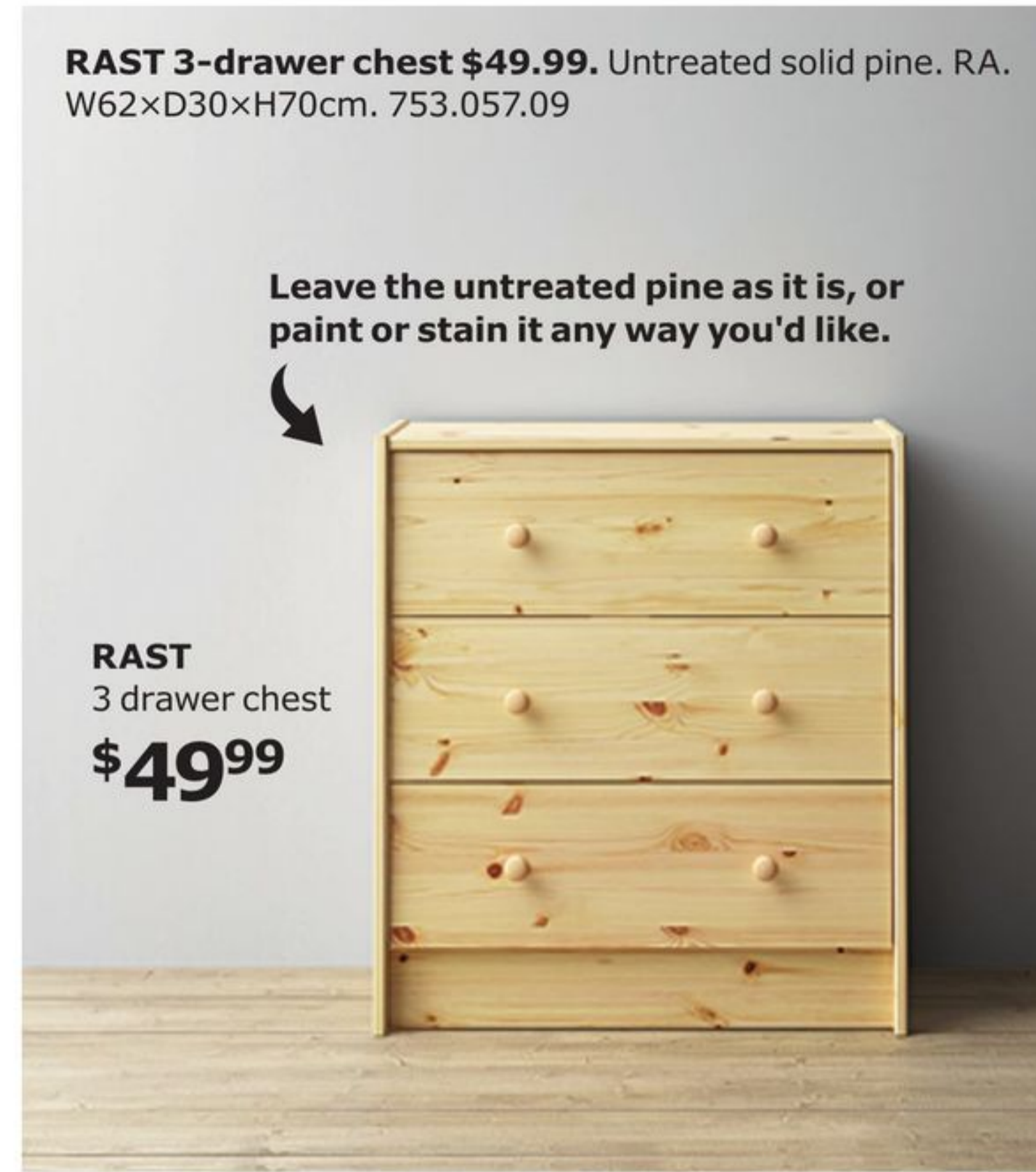

RAST 3-drawer chest \$49.99. Untreated solid pine. RA. W62xD30xH70cm. 753.057.09

RAST
3 drawer chest
\$49⁹⁹



HEMNES
8 drawer dresser
\$299

HEMNES 8 drawer dresser \$299. Stained, clear lacquered solid pine. Designer: K Hagberg/M Hagberg. RA. W160xD50xH95cm. 103.229.72



HEMNES
dressing table with mirror
\$249

HEMNES dressing table with mirror \$249. Painted finish, tempered glass and mirror glass. Designer: Carina Bengs. W100xD50xH159cm. RA. 101.212.28

RA=REQUIRES ASSEMBLY

KARMSUND standing mirror \$59.99. Powder-coated steel and mirror glass. Designer: A Efverlund/C Ke. RA. W40xH167cm. 402.949.82



KARMSUND
standing mirror
\$59⁹⁹

Secure It! Prevent tip-over accidents in the home. Furniture with included restraints must be secured to the wall. IKEA.ca/SaferHomesTogether



NORDLI 8-drawer dresser \$369. Modular system can be combined in many ways. Particleboard, Acrylic paint Designer: Ola Wihlborg. W120xD43xH97cm. 691.621.94



LOTE
3 drawer chest
\$34⁹⁹

LOTE 3 drawer chest \$34.99. Powder-coated steel and plastic. Designer: David Wahl. RA. W55xD36xH62cm. 502.937.22

On-time departures

A little organization goes a long way toward making hectic comings and goings go a lot smoother – when coats, bags, keys and shoes are all right where you expect them to be.



New MÅLARNA blackboard planner \$49.99. Painted finish. W90×H60cm. 603.111.55

HEMNES bench with shoe storage \$69.99. Painted solid birch and powder-coated steel. Designer: Carina Bengs. RA. W85×D32×H65cm. 002.438.00



HEMNES bench with shoe storage \$69.99



ISFJORDEN standing mirror \$129

ISFJORDEN standing mirror \$129. Mirror glass and stained, clear lacquered solid pine. Designer: Kai Legaard. RA. W47×H182cm. Black-brown 302.174.99



NEW LOWER PRICE
HEMNES
Shoe cabinet with two compartments
Was \$169
\$149

HEMNES series. Stained, clear lacquered solid pine. **Shoe cabinet with 2 compartments \$149.** Was \$169. Designer: K Hagberg/M Hagberg. RA. W89×D30×H127cm. 402.169.08
Mirror \$49.99. W60×H90cm. Black brown 001.228.22

RA=REQUIRES ASSEMBLY

Have you found the perfect fit?



NEW LOWER PRICE

HEMNES

shoe cabinet with two compartments
Was \$169

\$149

The HEMNES shoe cabinet may not take your collection out of mind, but definitely out of sight. For safety reasons it must be connected to the wall, and like all home improvements it comes with a bonus: Perhaps you can fit a new pair into all that space you've just freed up?

HEMNES shoe cabinet with 2 compartments \$149. Was \$169. Painted finish. Designer: K Hagberg/M Hagberg. RA. W89×D30×H127cm. 201.695.59 **Shop online at IKEA.ca**

Don't sweat the small stuff...

...just organize it. Boxes and baskets in all shapes and sizes make it easy to sort everything from crafts to paperclips – for less clutter and less time spent looking for things, too.



Fold the top down for a low, open basket that displays what's inside.

New FLÄDIS
basket, Ø25, H32cm
\$12⁹⁹

New FLÄDIS series. Seagrass.
Basket **\$12.99**. Ø25, H32cm. 603.221.73
Basket **\$19.99**. Ø37, H41cm. Seagrass/black 003.221.71

PALLRA
mini chest with 3 drawers
\$19⁹⁹

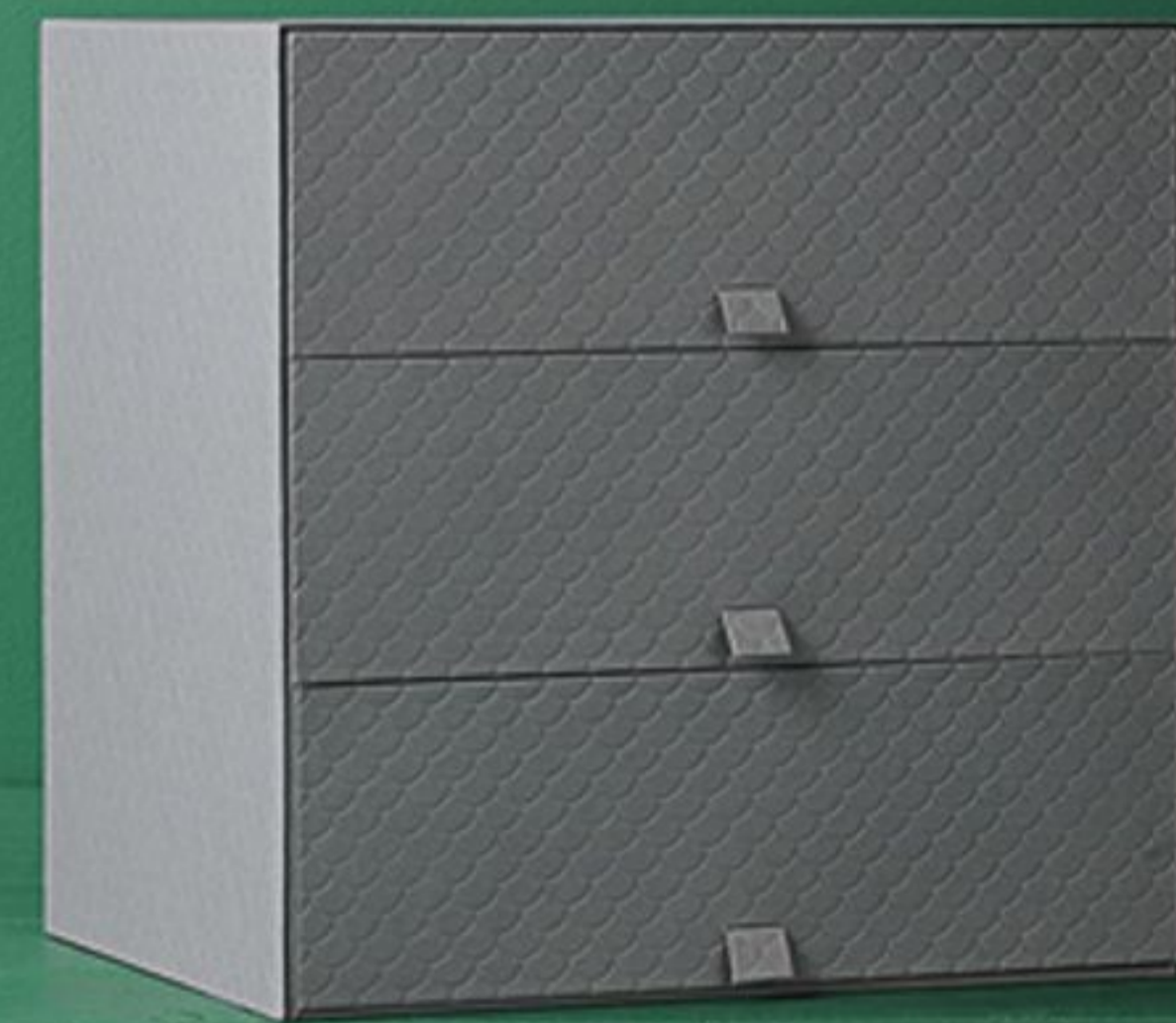

PALLRA mini chest with 3 drawers **\$19.99**.
Paper. RA. W31×D26×H31cm. 502.724.80

RA=REQUIRES ASSEMBLY



PALLRA
box with lid, set of 4
light blue
\$14⁹⁹

PALLRA series. Paper.
Box with lid, set of 4 **\$14.99**.
Includes: 2 small boxes (10×10×10cm), 1 medium box (21×10×10cm) and 1 large box (22×22×12cm). Light blue 202.724.91
Box with lid **\$9.99**. Ø22, H15cm. Light pink 102.724.82



New SKUBBARE
basket
\$9⁹⁹

New SKUBBARE basket **\$9.99**. 100% polyester. W36×D25×H38cm.
003.263.05



TJENA
box with lid, light blue
\$4⁹⁹

TJENA series. Paper. RA.
Box with lid **\$2.99**. W13×D26×H10cm. White 502.636.21
Box with compartments **\$3.99**. W27×D35×H10cm. Black 602.636.06
Box with lid **\$4.99**. W27×D35×H20cm. Light blue 703.237.80

FJÄLLA
box with lid
W22×D27×H16cm
\$6⁹⁹



FJÄLLA series. Paper and steel.
Box with lid **\$6.99**. W22×D27×H16cm. Off-white 502.920.01
Box with lid **\$16.99**. W40×D56 (including handle), H28cm. Off-white 202.699.50
Box with lid **\$9.99**. W27×D36×H20cm. Yellow 403.253.18



DRÖNA
box
\$6⁹⁹/ea

DRÖNA box **\$6.99/ea**. 100% polyester and paper board.
RA. W33×D38×H33cm. 003.239.72



New ELVARLI clothes storage combination \$167. Lacquered aluminum. RA. W46×D36×H222–350cm. 291.576.08

A modular storage system you can fit anywhere. No walls needed – it attaches to the ceiling.

New ELVARLI clothes storage combination \$167

STÄLL shoe cabinet with 4 compartments \$149. Painted finish. Designer: Sarah Fager. RA. W96×D17×H90cm. 701.781.70
LANGESUND mirror \$39.99. Mirror glass and aluminum. Designer: Ola Wihlborg. Ø50cm. White 402.886.79

STÄLL shoe cabinet with 4 compartments \$149



TJUSIG series. Painted solid hardwood and stainless steel. Designer: Henrik Preutz. RA. **Hat rack \$34.99.** W79×D32×H25cm. White 401.526.33
Shoe rack \$29.99. If you need more storage space for your shoes, simply stack one shoe rack on top of another. Holds a min. of 6 pairs of shoes. W79×D32×H37cm. White 301.526.38



TJUSIG hat rack \$34.99

KROKIG wall storage with hooks \$4.99



KROKIG series. Wall storage with hooks \$4.99. Polypropylene plastic. Designer: Henrik Preutz. W36×D20×H29cm. 202.235.18
Wall hook \$3.99/3 pack. ABS plastic. Designer: A Huldén/S Dahlman. 401.933.32



BISSA shoe cabinet with 2 compartments \$29.99

BISSA shoe cabinet with 2 compartments \$29.99. Foil finish. Designer: Sarah Fager. RA. W49×D28×H93cm. 502.427.37

ALGOT wall upright/mesh baskets \$95. Powder-coated steel. RA. W65×D40×H196cm. 691.841.67

ALGOT wall upright/mesh baskets \$95



ENUDDEN hat and coat stand \$44.99

ENUDDEN hat and coat stand \$44.99. Powder-coated steel. Designer: Inma Bermudez. RA. Ø45, H170cm. 202.469.06

RA=REQUIRES ASSEMBLY



New SALTRÖD mirror with shelf and hooks \$64.99

New SALTRÖD mirror with shelf and hooks \$64.99. Painted finish and mirror glass. Designer: Ebba Strandmark. RA. W50×H68cm. 802.970.02

Securely hangs on a door, for a quick check before heading out.

GARNES over-the-door mirror with hooks/shelf \$24.99

GARNES over-the-door mirror with hooks & shelf \$24.99. Powder-coated steel and mirror glass. Designer: Ola Wihlborg. RA. W38×H83cm. 402.851.38



Refurnish for a refresh

Swap out your bathroom furniture to turn a chaotic routine into a calm one. Our cabinets, lighting, mirrors and sinks add functionality and good organization while saving space, so you can turn any bathroom into a retreat.



LILLÅNGEN sink cabinet with 1 door \$119. Particleboard, foil, ceramic. RA. W40×D41×H92cm. White 491.553.83
Faucet sold separately.

ENSEN bathroom faucet \$119. Chrome-plated brass. Designer: Niels Gammelgaard. H12cm. 202.813.82

LILLÅNGEN
sink cabinet
with 1 door
\$119
(faucet sold separately)



New GODMORGON/ODENSVIK
sink cabinet with 2 drawers

\$349
(faucet sold separately)

SÖDERSVIK LED wall lamp \$89.99/ea. Built-in LED light source. Polycarbonate plastic and aluminum. Designer: Lycke von Schantz. L70×W12cm. 702.480.74

GODMORGON mirror \$29.99. Mirror glass W60×H96cm. 301.491.32

DALSKÄR bathroom faucet \$89.99. Chrome-plated brass. Designer: Magnus Elebäck. RA. H18cm. 202.812.97

New GODMORGON/ODENSVIK sink cabinet with 2 drawers \$349. Particleboard, melamine foil, ceramic, coloured glaze. RA. W63×D49×H64cm. Light grey 391.554.54
Faucet sold separately.

New GODMORGON wall cabinet with 1 door \$119/ea. Foil finish and tempered glass. RA. W40×D32×H58cm. Light grey 903.304.35

RA=REQUIRES ASSEMBLY

SILVERÅN mirror cabinet \$99. Stained, clear lacquered solid pine and mirror glass. Designer: T Christensen/K Legaard. RA. W60×D14×H68cm. Light brown 302.707.69

RUNSKÄR bathroom faucet \$69.99. Chrome-plated brass. H10cm. 802.621.25

SILVERÅN/HAMNVIKEN sink cabinet with 2 doors \$229. Stained, clear lacquered solid pine and ceramic. Designer: T Christensen/K Legaard. RA. W63×D45×H90.5cm. Light brown 690.203.88
Faucet sold separately.



SILVERÅN/HAMNVIKEN
sink cabinet with 2 doors
\$229
(faucet sold separately)

VITEMÖLLA wall lamp \$29.99/ea. Stoneware and glass. Designer: P Amsell/B Berlin. Shade Ø13cm. RA. H20cm. 202.387.46

HEMNES mirror cabinet with 1 door \$149. Painted finish and mirror glass. Designer: T Christensen/K Legaard. RA. W63×D16×H98cm. White 702.176.71

RUNSKÄR bathroom faucet \$69.99. Chrome-plated brass. H10cm. 802.621.25

HEMNES/RÄTTVIKEN sink cabinet with 2 drawers \$299 Painted finish and ceramics. Designer: T Christensen/K Legaard. RA. W63×D49×H89cm. White 599.060.72
Faucet sold separately.

All in easy reach –
whether you hide
things away or put
them on display.

HEMNES/RÄTTVIKEN
sink cabinet with 2 drawers

\$299
(faucet sold separately)



DALSKÄR bathroom faucet \$89.99. Chrome-plated brass. Designer: Magnus Elebäck. RA. H18cm. 202.812.97

GODMORGON/ALDERN/TÖRNVIKEN sink cabinet with countertop 45cm vessel sink \$449. Can be mounted on wall. Particleboard, Foil, ABS plastic, Foil. RA. W82×D49×H74cm. Faucet and legs sold separately.

GODMORGON leg, round \$10/ea. Stainless steel. Designer: Francis Cayouette. H22–25cm. 101.777.67

GODMORGON/ALDERN/TÖRNVIKEN
sink cabinet with
countertop 45cm vessel sink

\$449
(faucet and legs sold separately)



FULLEN/TÄLLEVIKEN
sink cabinet
\$79.99
(faucet sold separately)

OLSKÄR bathroom faucet \$29.99. Chrome-plated brass. RA. H12cm. 802.190.33

FULLEN/TÄLLEVIKEN sink cabinet \$79.99. Foil finish and ceramic. RA. W61×D41×H87cm. White 698.914.47
Faucet sold separately.



**NEW
LOWER
PRICE**

BOLMEN
step stool
Was \$9.99
\$7.99



BOLMEN step stool \$7.99. Was \$9.99. Polypropylene plastic. Designer: K Hagberg/M Hagberg. W44xD35xSeat H25cm. Blue 902.913.30

GUNNERN
lockable cabinet
\$39.99



GUNNERN lockable cabinet \$39.99. Powder-coated steel and mirror glass. Designer: T Christensen/K Legaard. W32xD10.4xH32cm. White 802.620.88

RÖNNSKÄR
shelving unit
\$49.99



RÖNNSKÄR shelving unit \$49.99. Tempered glass and powder-coated steel. Designer: Jon Karlsson. RA. W42xD40xH103cm. Black 100.937.63

RÅGRUND
chair with towel rack

\$59.99/ea



RÅGRUND chair with towel rack \$59.99/ea. Clear lacquered bamboo. Designer: David Wahl. RA. W39xD44xH140cm. 902.530.74

MOLGER shelving unit \$69.99. Clear lacquered solid birch. Designer: Richard Clack. RA. W37xD37xH140cm. Birch 201.545.91



MOLGER shelving unit \$69.99

GRUNDTAL
cart
\$49.99



GRUNDTAL cart \$49.99. Stainless steel and plastic. Designer: K Hagberg/M Hagberg. RA. W48xD24xH77cm. Stainless steel 601.714.33

RA=REQUIRES ASSEMBLY

You can store extra towels and bathroom supplies inside.



SILVERÅN
storage bench
\$59.99



SILVERÅN storage bench \$59.99. Foil finish. Designer: T Christensen/K Legaard. RA. W54.4xD35xH46.6cm. White 402.745.21

MOLGER
step stool
\$34.99



MOLGER step stool \$34.99. Clear lacquered solid birch. Designer: Eva Lilja Löwenhielm. RA. W41xD44xH34cm. Birch 902.414.63

No drilling and no electrician needed with this battery-powered LED lamp. You can fix it to the wall with suction cups or double-sided tape and direct the light at the best angle.



BLÅVIK LED wall lamp with mirror \$19.99. ABS plastic, polycarbonate plastic and steel. Designer: Ola Wihlborg. Ø20cm. Requires 3 AA batteries, sold separately. White 003.123.08

BRICKAN wall shelf \$49.99. Powder coated/galvanized steel and plastic. Designer: Marcus Arvonen. W33xD20xH33cm. White 502.994.08

BRICKAN
wall shelf
\$49.99



New DOFTKLINT shower curtain \$9.99. 100% polyester. Designer: S Edholm/L Ullenius. W180xL180cm. Multicolour 103.221.75

New DOFTKLINT shower curtain \$9.99



BADAREN bathroom mat \$6.99

BADAREN bathroom mat \$6.99. 100% polyester. Ø55cm. Green 703.069.45



01 FRÄJEN bath towel \$6.99/ea. 100% cotton. W70xL140cm. Green 402.954.01
02 HÄREN bath towel \$3.99/ea. 100% cotton. W70xL140cm. Turquoise 101.635.48
 Both bath towels are available in several colours.

02 HÄREN bath towel \$3.99/ea



No drilling needed – just press the suction cups.

STUGVIK hook with suction cup, 2 pack \$7.99

STUGVIK series. Plastic and synthetic rubber.
Basket with suction cup \$9.99. W28xD17xH19cm. 502.493.81
Hook with suction cup \$7.99/2 pack. 802.404.40



KALKGRUND towel rail \$19.99

KALKGRUND towel rail \$19.99. Chrome-plated zinc. Designer: Henrik Preutz. L65cm. 902.914.72
SALVIKEN bath towel \$9.99. 100% cotton. Designer: Paulin Machado. W70xL140cm. White 503.132.25

EKOLN soap dispenser \$8.99



EKOLN series. Stoneware. Designer: Anna Efverlund.
Soap dispenser \$8.99. H18cm. 602.915.10
Toothbrush holder \$5.99. H11cm. 102.930.45



NEW LOWER PRICE
BALUNGEN mirror \$14.99
 Was \$19.99

BALUNGEN mirror \$14.99. Was \$19.99. Stainless steel and glass. Designer: Ebba Strandmark. RA. H36cm. 502.930.34



NORDRANA basket, set of 2 \$12.99

NORDRANA basket, set of 2 \$12.99. Sizes (LxW): 1 pc 27x27 cm and 1 pc 21x22 cm. 100% polypropylene. Designer: J Jelinek/H Dalrot. Grey102.882.99



The jacquard weave gives the towel a reverse pattern on the back.

BLÄDJAN bath towel \$14.99

BLÄDJAN bath towel \$14.99. 100% cotton. W70xL140cm. Multicolour 103.130.53

A refreshing start

Being ready for the day ahead starts with a good night's sleep in a bed that's completely comfortable for you. That just-right firmness in the mattress and pillow, and just-right warmth of the duvet. Choose yours to wake up just right.



Tammy
Sales Responsible, Sweden

You probably know already that we have mattresses. You might not know that we design them with the IKEA idea of 'complete comfort' in mind. So that your mattress combines perfectly with the pillows, duvet, protector, pad and even the bed base to bring you a really good night's sleep.

DOFRANKA full (double)/queen duvet cover and 2 pillowcases \$59.99. 50% lyocell, 50% cotton. Designer: Susanna Hoikkala. 003.089.00

BLEKVIDE full (double)/queen duvet, cool \$139. Filling: 90% duck down and 10% duck feathers. 802.714.22

KNAVEL queen pillow, firm \$89.99. Fabric: 100% cotton. Pocket filling: 90% duck down, 10% duck feathers. Core filling: 75% duck down, 25% duck feathers. 202.694.84

HJELLESTAD queen pocket spring mattress with memory foam pillow top \$799.

Was \$899. An integrated pillowtop with memory foam that moulds to your body followed by double layers of pocket springs that give exact support. Just a dream? No, it's HJELLESTAD pocket spring mattress. Designer: Synnöve Mork. 39cm thick. 803.072.99



**NEW
LOWER
PRICE**

HJELLESTAD
queen pocket spring mattress with
memory foam pillowtop
Was \$899

\$799





01 ÄRENPRIS
queen pillow, firm
\$14⁹⁹

**NEW
LOWER
PRICE**

04 RÖDTOPPA
full (double)/queen
duvet, cool
Was \$59.99
\$49⁹⁹

01 ÄRENPRIS queen pillow, firm \$14.99. Filling: polyester fibres. 902.696.78 **02 ÄRENPRIS queen pillow, soft \$13.99** Filling: polyester fibres. 302.696.81 **03 RÖDTOPPA full (double)/queen duvet, warm \$79.99.** Filling: 50% lyocell and 50% polyester. 902.715.44 **04 RÖDTOPPA full (double)/queen duvet, cool \$49.99.** Was \$59.99. Filling: 50% lyocell and 50% polyester. 602.715.07



HAUGESUND queen pocket spring mattress \$299. The individually wrapped pocket springs move independently and follow your body exactly. Comes roll-packed, easy to take home. Available in firm or medium firm comfort. 25cm thick. 703.073.08

HAUGESUND
queen pocket
spring mattress
\$299

HAMPDÅN queen pillow, soft \$5.99/ea. Filling: polyester fibres. 802.697.54 **TILKÖRT full (double)/queen duvet, cool \$19.99/ea.** Filling: polyester fibres. 402.718.67



HAMPDÅN
queen pillow, soft
\$5⁹⁹/ea



HÖNSBÄR
full (double)/queen duvet,
warm
\$69⁹⁹

HÖNSBÄR full (double)/queen duvet, warm \$69.99. Filling: 80% duck feathers and 20% duck down. 302.716.98



Each pocket spring works independently to support your body's contours.

HESSTUN
queen pocket spring mattress
with memory foam pillow top
\$549

HESSTUN queen pocket spring mattress with memory foam pillow top \$549. Double layers of individually wrapped pocket springs that follow your body exactly, topped with a generous layer of memory foam. HESSTUN pocket spring mattress is a perfect combination of support and comfort. Designer: Synnöve Mork. 32cm thick. 403.073.00



MEISTERVIK
twin foam mattress
\$149

MEISTERVIK twin foam mattress \$149. Comes roll-packed, easy to take home. 12cm thick. 403.304.71



01 TANANGER
queen memory foam
mattress topper
\$129

01 TANANGER queen memory foam mattress topper \$129. Filled with memory foam that moulds to your body, enables you to relax more fully, and gives a firmer sleep surface. Designer: Synnöve Mork. 6cm thick. 002.982.46 **02 TROMSDALEN queen mattress topper \$349.** Natural materials like natural latex and cotton wick away moisture and let you enjoy a fresh, natural sleeping surface. 7cm thick. 803.312.99



Build your idea of completely comfortable sleep—choose how firm you would like your mattress, then select a firm or soft pillow, and a warm or cool duvet.

01

02

03 **HYLLE**
queen pillow, firm
\$19⁹⁹/ea

04 **GLANSVIDE**
full(double)/queen
duvet, warm
\$99/ea

05 **HOLMSBU**
queen pocket spring mattress
\$999

01 UNDREDAL nightstand \$169. Fibreboard, acrylic paint. RA. W67×D49×H74cm. Black 302.984.76 **02 UNDREDAL queen bed frame \$449.** Painted finish. RA. Slatted bed base, mattress and bedlinens sold separately. Black 990.601.13 **03 HYLLE queen pillow, firm \$19.99/ea.** Filling: polyester fibres. 602.827.37 **04 GLANSVIDE full (double)/queen duvet, warm \$99/ea.** Filling: 100% polyester microfibre 002.714.83 **05 HOLMSBU queen pocket spring mattress \$999.** Experience weightless comfort on a surface of cooling memory foam together with a layer of mini pocket springs on top of individually wrapped pocket springs that support and cradle your body. Designer: Synnöve Mork. 45cm thick. 403.072.96

RA=REQUIRES ASSEMBLY



HAUGSVÄR queen pocket spring mattress \$499. The individually wrapped pocket springs in HAUGSVÄR work independently and closely follow your body. A generous layer of memory foam nearest your body provides enhanced comfort. Comes roll-packed, easy to take home. Designer: Synnöve Mork. 28cm thick. 703.073.13

HAUGSVÄR
queen pocket spring
mattress
\$499



HASVÅG queen spring mattress \$269. HASVÅG spring mattress has Bonnell springs and a layer of soft filling to give support and comfort, so that you can get a good night's sleep. Designer: Synnöve Mork. 21cm thick. 603.072.81

HASVÅG
queen spring
mattress
\$269

RÖLLEKA memory foam pillow \$16.99. Filling: memory foam. L33×W50cm. 102.698.37
GRUSBLAD full (double)/queen duvet, warm \$39.99. Filling: polyester fibres. 702.717.62

RÖLLEKA
memory foam pillow
\$16⁹⁹



TUSSÖY queen mattress topper \$199. Filled with memory foam that moulds to your body, enables you to relax more fully, and gives a firmer sleep surface. Designer: Synnöve Mork. 8cm thick. 402.981.45

TUSSÖY
queen mattress topper
\$199



Delivery service. We can bring your purchases to your home or business. Prices from \$79. See page 309.

Snuggle-worthy in every way

Natural ingredients for a good night's sleep: fabrics that are made in a more sustainable way, feel good against your skin, and are designed in colours and patterns that give a fresh feeling to your bedroom.

Linen is breathable and absorbs moisture for a just-right temperature all night.

LINBLOMMA
full (double)/queen duvet cover and 2 pillowcases
\$99⁹⁹

LINBLOMMA full (double)/queen duvet cover and 2 pillowcases \$99.99. 100% linen. Natural 601.900.97

HÄXÖRT
full (double)/queen duvet cover and 2 pillowcases
\$69⁹⁹

HÄXÖRT full (double)/queen duvet cover and 2 pillowcases \$69.99. 100% cotton percale. 250 thread count. White 703.139.22

Made from 100% cotton that is grown using methods that are better for the environment and farmers.

New ÄNGSLILJA
full (double)/queen duvet cover and 2 pillowcases
\$49⁹⁹

New ÄNGSLILJA full (double)/queen duvet cover and 2 pillowcases \$49.99. 100% cotton. Light blue 003.186.16

STENÖRT
full (double)/queen duvet cover and 2 pillowcases
\$69⁹⁹

STENÖRT full (double)/queen duvet cover and pillowcases \$69.99. 100% cotton percale. 250 thread count. Multicolour 603.139.51

NYPONROS
full (double)/queen duvet cover and 2 pillowcases
\$49⁹⁹

NYPONROS full (double)/queen duvet cover and 2 pillowcases \$49.99. 100% yarn dyed cotton. 152 thread count. White/blue 001.891.53

ALVINE STRÅ
full (double)/queen duvet cover and 2 pillowcases
\$59⁹⁹

ALVINE STRÅ full (double)/queen duvet cover and 2 pillowcases \$59.99. 100% cotton. 190 thread count. Designer: Kristina Pihl. White 300.464.74

HÖSTÖGA
full (double)/queen duvet cover and 2 pillowcases
\$24⁹⁹

HÖSTÖGA full (double)/queen duvet cover and 2 pillowcases \$24.99. 100% cotton. Striped grey 603.141.11

LJUSÖGA full (double)/queen duvet cover and 2 pillowcases \$34.99. 100% cotton. 144 thread count. Multicolour 903.143.60

LJUSÖGA
full (double)/queen duvet cover and 2 pillowcases
\$34⁹⁹

BACKVIAL
queen/king bedspread
\$39⁹⁹

BACKVIAL queen/king bedspread \$39.99. 100% cotton. Designer: Kazuyo Nomura. Fits queen or king bed. W250xL250cm. Black/white 002.830.23



RÖDVED
full (double)/queen duvet
cover and 2 pillowcases
\$16⁹⁹

RÖDVED full (double)/queen duvet cover and 2 pillowcases \$16.99.
52% polyester, 48% cotton. Designer: Linda Svensson Edevint. White/green 703.043.19

New DOFTKLINT
full(double)/queen duvet
cover and 2 pillowcases

\$39⁹⁹



New DOFTKLINT full (double)/queen duvet cover and 2 pillowcases \$39.99. 100% cotton. 144 thread count. Designer: S Edholm/L Ullenius. White/multicolour 203.244.33

FLÖNG full(double)/queen duvet cover and 2 pillowcases \$34.99.
100% cotton. Designer: Nina Jobs. Blue/white 803.090.38

FLÖNG
full (double)/queen
duvet cover and
2 pillowcases
\$34⁹⁹



MOSSFLOX full (double)/queen duvet cover and 2 pillowcases \$29.99. 100% cotton. 144 thread count. Designer: Nina Jobs. Multicolour 803.089.63



MOSSFLOX
full (double)/queen duvet
cover and 2 pillowcases
\$29⁹⁹

TRÄDASTER
twin duvet cover
and pillowcase
\$9⁹⁹



TRÄDASTER twin duvet cover and pillowcase \$9.99.
2% polyester, 48% cotton. Designer: Paulin Machado. Orange 103.292.66 **Full/double duvet cover and 2 pillowcases \$13.99.** Orange 603.292.64

PRAKTTRY full (double)/queen duvet cover and 2 pillowcases \$59.99. 55% lyocell and 45% cotton satin. 207 thread count. Grey/white/beige 203.090.03



PRAKTTRY
full (double)/queen
duvet cover and
2 pillowcases
\$59⁹⁹

**BOLLTISTEL full (double)/queen
duvet cover and 2 pillowcases
\$59.99.** 55% lyocell and
45% cotton satin.
207 thread count.
Designer: Andreja Špegel
Grey/yellow 702.865.32



BOLLTISTEL
full (double)/queen
duvet cover and
2 pillowcases
\$59⁹⁹

VÄRÄRT full (double)/queen duvet cover and 2 pillowcases \$69.99.
100% cotton percale. 250 thread count. Beige 602.877.11

VÄRÄRT
full (double)/queen duvet
cover and 2 pillowcases
\$69⁹⁹



New ÄNGSTÖREL queen/king bedspread \$29.99. 100% cotton. Fits queen or king bed. W250xL250cm. Blue check 103.280.97

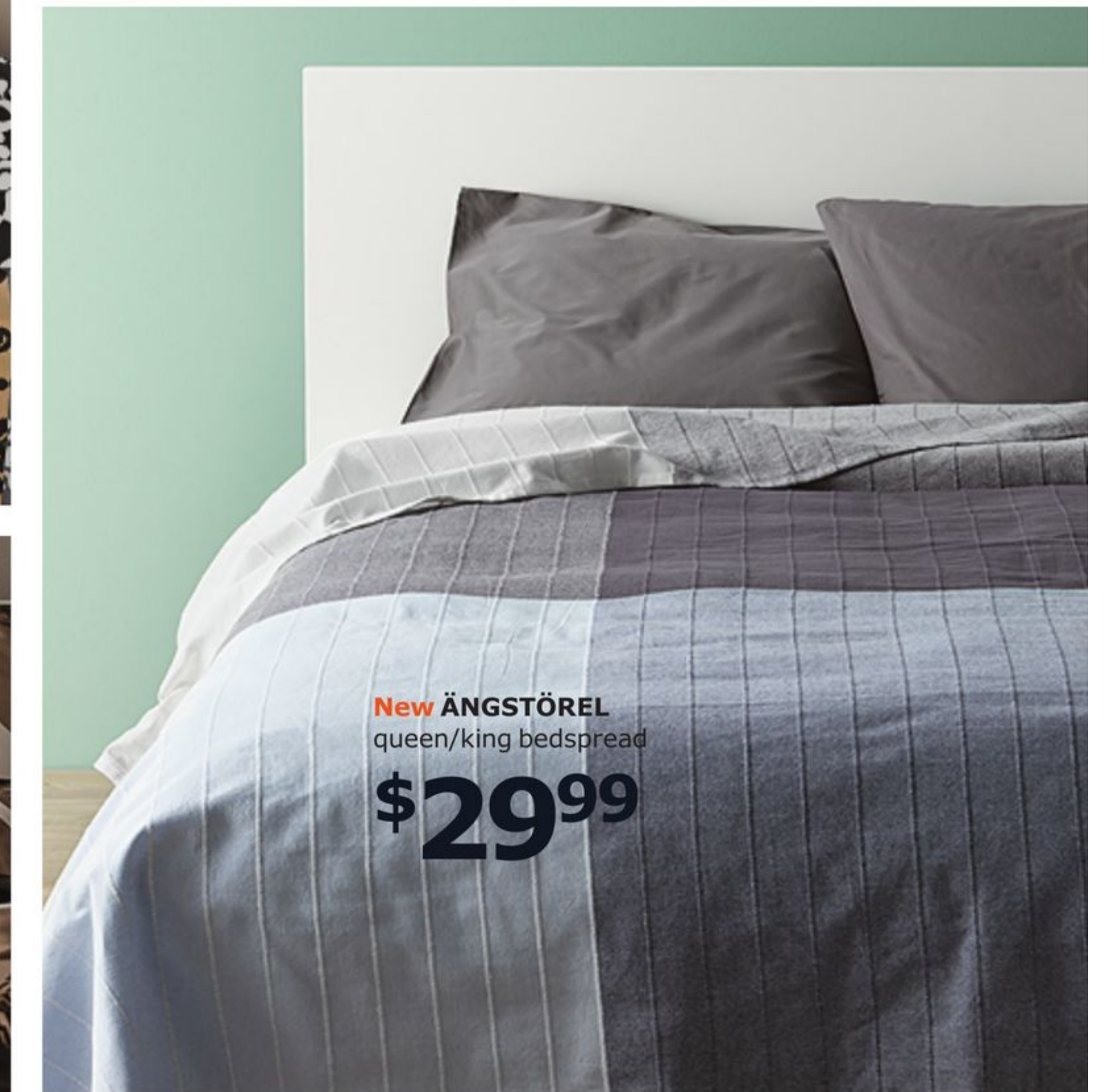

New ÄNGSTÖREL
queen/king bedspread
\$29⁹⁹

ROSTVIN
full (double)/queen duvet
cover and 2 pillowcases
\$24⁹⁹



ROSTVIN full (double)/queen duvet cover and 2 pillowcases \$24.99.
100% cotton. White/grey 703.090.67

The heart of the bedroom

Your bed is the focal point of your bedroom, and good sleep – night after night. Choose the one that fits your space and your idea of a retreat. It's all part of feeling refreshed.



BRUSALI
nightstand
\$69.99

BRUSALI nightstand \$69.99.
Foil finish. Designer: T Christensen/K Legaard. RA. W44×D36×H62cm. Brown 502.501.57

BRUSALI queen bed frame with 4 storage drawers \$349. Foil finish. RA. Brown 990.075.83 Also available in white.



BRUSALI
queen bed frame with
4 storage drawers
\$349



TYSSEDAL series. White. Galvanized steel. RA.
Queen bed frame \$399. Slatted bed base sold separately. 090.577.99
Nightstand \$89.99/ea. Was \$119. W51×D40×H59cm. 702.999.59

TYSSEDAL
queen bed frame
\$399



New KOPARDAL
queen bed frame
\$199

New KOPARDAL queen bed frame \$199. Powder-coated steel. Slatted bed base sold separately. Grey 691.576.68

New FYRESDAL twin daybed \$269.
Powder coated steel. Black 403.188.84



With two mattresses, it's a sofa, single bed and double bed in one.

New FYRESDAL
twin daybed
\$269

HEMNES
twin daybed with 3 drawers
\$399



HEMNES twin daybed with 3 drawers \$399. Painted finish and polyurethane foam. RA. White 300.803.16 Also available in black.

HEMNES series. Stained, clear lacquered solid pine. RA.
Queen Bed frame \$279. Slatted bed base sold separately. Black-brown 199.315.92 **Nightstand \$69.99.** Designer: Nike Karlsson. W46×D35×H70cm. Yellow 703.200.17 Also available in white stain.

HEMNES
queen bed frame
\$279



FJELLSE
full/double bed frame
\$99



FJELLSE full/double bed frame \$99. Untreated solid pine. Designer: Jon Karlsson. RA.190.098.21



TRYSIL queen bed frame \$199. Foil finish and powder-coated steel. RA. Brown 490.078.11

MALM series. RA.
Queen high bed frame with 4 storage drawers \$399. Brown stained ash veneer. 091.312.85 **2-drawer chest \$69.99.** Painted finish. W40xD48xH55cm. Light green 503.113.11



Delivery service. We can bring your purchases to your home or business. Prices from \$79. See page 309.

Sometimes the simple things are simply the best



The ASKVOLL bed frame knows when not to complicate things. A solid design that fits easily into your home without making a big noise about it. Isn't that just what you want for a good night's sleep?

ASKVOLL queen bed frame \$189. Was \$199. Foil finish. RA. White 990.304.80
Shop online at [IKEA.ca](https://www.ikea.com)

For all bed frames on these pages: Slatted bed base and midbeam included, unless otherwise specified. Mattress and bedlinens sold separately.

A caring start for baby... and you

A room filled with love, a safe and cozy place for restful sleep, good organization for all the little things and smart solutions that make nurturing your growing baby easier—all meeting the strictest child safety standards in the world.

CHARMTROLL crib duvet cover/pillowcase \$14.99. 50% cotton, 50% lyocell. Designer: Silke Leffler. Duvet cover W110xL125cm. Pillowcase W35xL55cm. 902.899.97



CHARMTROLL
crib duvet cover/
pillowcase
\$14.99



You can remove one side when your child is big enough to climb out.

SNIGLAR
crib
\$99

New HIMMELSK
mobile
\$9.99

SNIGLAR series. Untreated solid beech. RA. **Crib \$99.** Mattress and bedlinens are sold separately. W74xL137xH84cm. Mattress size 70x132cm. 502.485.41 **Changing table \$44.99.** L72xW53xH87cm. 501.975.89 **New HIMMELSK mobile \$9.99.** 100% polyester. Designer: Susana Rodriguez Fernandez. 803.208.56

SUNDBIK series. Stained, clear lacquered solid pine. Designer: Jon Karlsson. RA. **Crib \$169.** Mattress and bedlinens are sold separately. W76xL138xH88cm. Mattress size 70x132cm. 302.485.75 **Wardrobe \$249.** W80xD50xH171cm. 102.696.96

RA=REQUIRES ASSEMBLY



Adapts to baby's growth – you can lower the mattress and remove one side of the crib as he or she gets older.

SUNDBIK
crib
\$169

TROGEN
wardrobe
\$269

TROGEN wardrobe \$269. Stained, clear lacquered solid pine. Designer: J Asshoff/H Brogård. RA. W89xD50xH187cm. 602.802.67

STUVA series. Foil and painted finish. Designer: Ebba Strandmark. RA. **Crib with drawers \$299.** Mattress and bedlinens are sold separately. W74xL139xH92cm. Mattress size 70x132cm. 799.270.02 **Changing table with 3 drawers \$234.** W90xD79xH102cm. 791.240.26

STUVA
crib with drawers
\$299

Easily converts to a desk or play surface after the diaper stage.



New STJÄRNBILD
duvet cover/pillowcase for crib
\$8.99



New STJÄRNBILD crib duvet cover/pillowcase \$8.99. 52% polyester, 48% cotton. Designer: Susana Rodriguez Fernandez. Duvet cover W110xL125cm. Pillowcase W35xL55cm. 603.196.65 **HIMMELSK rattle \$2.99.** 80% cotton, 20% polyester. Designer: Susana Rodriguez Fernandez. L16cm. 403.268.98

STICKAT
basket, set of 2.
\$9⁹⁹



STICKAT basket, set of 2 \$9.99. Sizes: 1 pc 20cm and 1 pc 13cm. 100 % polypropylene. Designer: Annie Huldén. 902.978.41



New DRÖMSYN
wall lamp
\$12⁹⁹

New DRÖMSYN wall lamp \$12.99. 100% polypropylene. Designer: Sarah Fager. L31xØ8xH21cm. 303.303.58. **SUNDBIK ext bed frame with slatted bed base \$199.** Mattress and bedlinens are sold separately. Stained, clear lacquered solid pine. RA. W108xL127-197xH80cm. Mattress size 97x196cm. Black-brown 590.422.15



New SLÄKTING
box
\$12⁹⁹

New SLÄKTING box \$12.99. 100% polyester. Designer: A Huldén/E Strandmark. W38xD42xH33cm. 103.279.36

TROFAST storage combination \$99. Foil finish and plastic. RA. W99xD44xH94cm. 591.289.35



TROFAST
storage combination
\$99



KURA
twin bed with tent
\$249

You can flip it to convert it to a loft bed with space to play underneath.

KURA series. Designer: T Christensen/K Legaard. RA. **Reversible twin bed \$229.** Mattress and bedlinens are sold separately. Clear lacquered solid pine and foil finish. W105xL199xH116cm. 802.538.14 **Bed tent \$20.** 100% polyester. W97xL189xH68cm. 602.966.02

RA=REQUIRES ASSEMBLY

At IKEA, safety is our top priority, which is why we are reminding customers to always follow assembly instructions and safety warnings carefully and to install any safety devices provided with our products.



HENSVIK
wardrobe
\$139

HENSVIK wardrobe \$139. Foil and painted finish. Designer: Carina Bengs. RA. W75xD48xH174cm. 901.113.91



FJÄDERMOLN
cushion
\$9⁹⁹

FJÄDERMOLN cushion \$9.99. 100% polyester. Designer: Malin Gyllensvaan. W34xL59cm. 602.644.32



MINNEN
ext bed frame with
slatted bed base
\$149

MINNEN ext bed frame with slatted bed base \$149. Mattress and bedlinens are sold separately. Powder coated steel. RA. W102xL125-195xH92cm. Mattress size 97x196cm. White 591.246.21 **SNÖIG wall lamp \$29.99.** Built-in LED light source. Powder coated steel. White 403.218.72

The centred ladder makes climbing in and out easier, and creates a guard rail for the one sleeping below.

TUFFING
twin bunk bed frame
\$169

TUFFING twin bunk bed frame \$169. Bed base included. Mattress and bedlinens are sold separately. Steel and polyester. RA. W103xL197xH130.5cm. 702.992.85
STICKAT bed pocket \$5.99. 100% polyester. Designer: Annie Huldén. W39xH30cm. 703.004.82

FLICKÖGA twin duvet cover and pillowcase \$39.99. 50% lyocell, 50% cotton. Designer: S Edholm/L Ullenius. 602.989.17

FLICKÖGA
twin duvet cover and pillowcase
\$39.99



DANSA
disco ball with LED light
\$39.99



DANSA disco ball with LED light \$39.99. Recommended for ages from 8 years. Powder-coated steel. Designer: Henrik Preutz. Ø21, H28.7cm. 402.409.27

FLAXA twin bed frame w/storage+slatted bedbase \$169. Mattress and bedlinens are sold separately. Fibreboard, acrylic paint. RA. 390.319.15
TALANGFULL twin duvet cover and pillowcase \$19.99. 100% cotton. Designer: Malin Unnborn. 002.725.62

FLAXA
twin bed frame w storage+ slatted bedbase
\$169



SVÄRTA twin loft bed frame with desk top \$349. Mattress and bedlinens are sold separately. Steel, Pigmented epoxy/polyester powder coating RA. W103xL198xH186cm. 291.542.09
JULES junior chair \$39.99. Steel/moulded plywood. RA. Seat W35xD32xH38-50cm. White/silver 198.850.43

You can put the ladder on the left or right, and create a workspace underneath with SVÄRTA desk top.

SVÄRTA
twin loft bed frame with desk top
\$349



New HEJSAN
box file, set of 3.
\$9.99



New HEJSAN box, set of 3 \$9.99. Includes: 2 boxes (L32xW23xH6.5cm) and 1 box (L21xW15xH5cm). Paper. Designer: S Edholm/L Ullenius. 903.243.16

Can be placed vertically, too, but horizontally is a perfect height for kids to reach everything and have a long surface on top.

KALLAX
shelving unit with doors
\$119.99

KALLAX shelving unit with doors \$119.99. Foil, painted fibreboard, and particleboard. RA. W77xD39xH147cm. 291.554.97

RA=REQUIRES ASSEMBLY



STUVA
wardrobe
\$179

STUVA series. Foil and painted finish. RA.
Wardrobe \$179. W60xD50xH192cm. 991.335.53
Bench \$49. W90xD50xH50cm. 301.286.29



At IKEA, product safety is our top priority, which is why we are reminding customers to always follow assembly instructions and safety warnings carefully and to install any safety devices provided with our products.

01 **New FLISAT**
doll's house/wall shelf
\$39⁹⁹



03 **New FLISAT**
book display
\$24⁹⁹



The top consists of two lids that fit TROFAST storage boxes to keep toys in reach and make cleaning up a snap.



06 **New FLISAT**
children's stool
\$19⁹⁹/ea



01–06 **New FLISAT series**. Solid pine. RA. **01 Doll house/wall shelf \$39.99**. Recommended for children 3 years and older. W58xD22xH59cm. 502.907.85 **02 Knob rack with 4 knobs \$6.99/ea**. W47xH4.5cm. 702.735.96 **03 Book display \$24.99**. W49xD28xH41cm. 002.907.83 **04 Toy storage with casters \$39.99**. Warning, this toy has no brake. Recommended for ages from 3 years. L44xW39xH31cm. 102.984.20 Shown here with **TROFAST storage box \$6/ea**. 956.851.00 **05 Children's table \$74.99**. L83xW58xH48cm. 502.984.18 Shown here with **TROFAST storage box \$4/ea**. Green 600.940.72 Yellow 503.080.02 **06 Children's stool \$19.99/ea**. W24xD24xH31cm. 402.735.93 **07 STICKAT stool cover \$6.99/ea**. 100 % cotton. Ø28cm. Pink 702.978.37 Green 402.962.74

At IKEA, product safety is our top priority, which is why we are reminding customers to always follow assembly instructions and safety warnings carefully and to install any safety devices provided with our products.

The best play-ground ever

Playing is important... it's how kids learn and grow, develop creativity, and relieve stress and feel happy. Especially when all that fun and learning is happening right there with you at home.



MULA
toddle truck
\$29⁹⁹

MULA toddle truck \$29.99. Recommended for children 12 months and older. Lacquered birch plywood and powder-coated steel. L40xW30xH46cm. RA. 302.835.78 **GOSIG GOLDEN soft toy \$7.99**. Recommended for all ages. Fabric: 100% polyester. Filling: polyester fibres. Designer: Annie Huldén. L40cm. 801.327.99

LÄTSAS
12-piece shopping basket set
\$9⁹⁹



Role-playing is fun, and it helps children develop social skills.

LÄTSAS 11-piece shopping basket set \$9.99. Includes: cheese, 2 sausages, pasta, bread, 1 green pepper, 1 pineapple, 1 egg-plant, and 1 fish. Recommended for ages from 3 years. Polyester fibre fill. Designer: A Huldén/S Dahlman. 002.620.06

When kids imitate grown-ups, they develop social skills like cooperation and problem-solving, all while having fun. This kitchen with its adjustable legs can spark an ongoing interest in food and cooking – without the mess.

DUKTIG
play kitchen
\$119



DUKTIG play kitchen \$119. Recommended for children 3 years and older. Birch plywood and polypropylene plastic. Designer: Mikael Warnhammar. W72xD40xH109cm. 603.199.72

MÅLA
easel
\$24⁹⁹



MÅLA easel \$24.99. Recommended for children 3 years and older. Solid pine. L43xW62xH118cm. 500.210.76 **MÅLA drawing paper roll \$5.99**. Chlorine free bleached paper. W45xL300cm. 803.240.72

RA=REQUIRES ASSEMBLY

MULA
crane with blocks
\$19⁹⁹



MULA crane with blocks \$19.99. Recommended for children 12 months and older. Stained, clear lacquered solid beech. Designer: Francis Cayouette. L28xW15xH11cm. 202.948.79

This is IKEA®

The IKEA idea began in rural Sweden, where thrift and creativity helped the people to succeed. Their approach inspires us still to make everyday life a little bit easier and more comfortable for as many people as we can. So you can browse and buy from a huge choice of home furnishings both in your local store and at IKEA.ca. If you ever need a hand, you can pick and choose from a number of helpful services.

306 Ways to Shop
309 Services
312 Return policy

313 Contact information
314 IKEA FAMILY
320 People & Communities

321 Warranties
325 Working with us
326 Index



Right at your fingertips, 24-7

At **IKEA.ca**, you can browse and buy thousands of home furnishing products you love online, whenever you'd like, and have them delivered straight to your home or business. Shop anytime at **IKEA.ca**!

We're also now closer than ever with our new Pick-up and order points. You can shop online and have as many items as you want delivered to any of the locations for only \$20. All of our Pick-up and order points also have takeaway items and IKEA co-workers on hand to help you style and plan your home.

Now open in London, Quebec City, St. Catharines, Windsor, Whitby, Kitchener

IKEA.ca/PickUpPoints

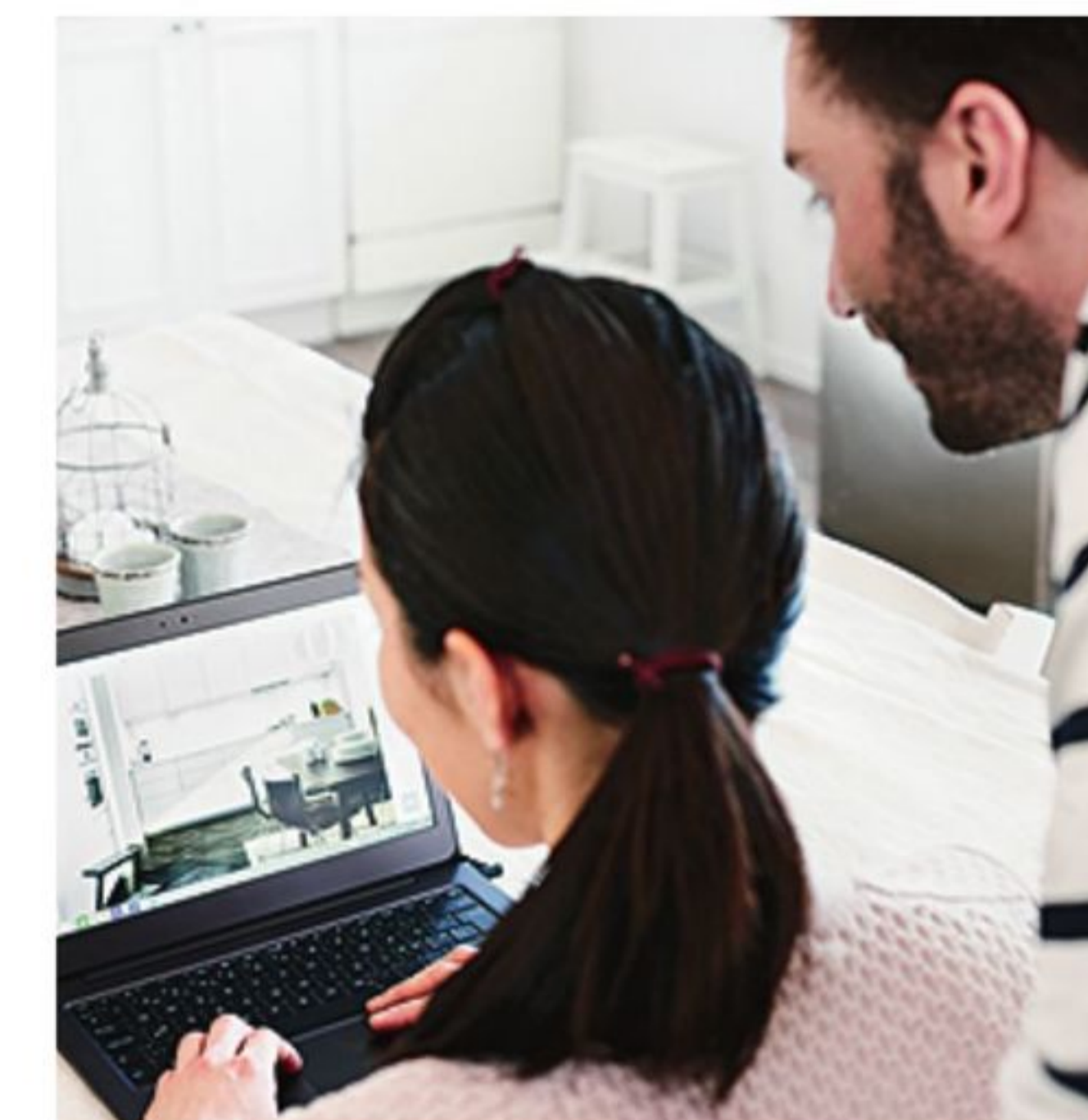

From the comfort of home

You can explore the IKEA range without leaving your home. At **IKEA.ca** there are lots of how to/DIY tips and inspiration to get your creative juices flowing. There are also tools to help you plan your home furnishing in the best way. Order your products online and have them delivered right to your door or to one of our Pick-up and Order Points.

Shopping on the go

If you have a tablet or a smartphone, you can soak up IKEA inspiration even on your morning commute – or wherever else you roam. The **IKEA Catalogue** app goes deeper into many ideas for every type of room, while the **IKEA Store** app can help to make shopping in person even quicker and easier.

Great ideas are all around

Inspiration can come from almost anywhere. The **IKEA Catalogue** app, brochures, magazines, social media, blogs, your friends and family – they can all help you to pinpoint the looks, the features and the materials that you'll love to live with. That saves you time when you start shopping because you have a better idea of what you're looking for.





The touch test

At your local store you can finally get hands-on with the home furnishings. You can size-up the sofas, compare the kitchens and peruse the price tags for as much time as you want. For up-to-date product and store information while you're there, you can check the IKEA Store app on your smartphone or ask a friendly co-worker.

You have great taste

Want time with a coffee to think about your home furnishing? Did you work up an appetite as you explored our room ideas? Your local IKEA Restaurant is the perfect place for a break – before, during or after your shop. Here you can refresh yourself from a wide menu of tasty food at inviting prices, all in a laid-back atmosphere.

Bringing it all home

When you shop in person at your local store, you can take home your new purchases and start to enjoy them the same day. Just remember first to check where you can pick up your items in the Market Hall or Self-serve furniture area. Or, you can call on our optional services for an even easier way to shop.



Sergio
Services Specialist, Spain

If your home furnishing project seems too big to handle all by yourself, please talk to us! We'll show you how quickly and affordably we can help to make any step of your shopping experience even easier. From picking out your purchases to installing a whole kitchen, you can call on any of our comprehensive choice of services whenever you need to.

If you need a hand, we're happy to help

Here are some of the services that you can arrange in your local store.



Prices from
\$99

Picking with Delivery service

We collect the items on your shopping list and deliver them to your home or business.



Prices from
\$79

Delivery service

We can deliver your furniture direct to your home or business.



Prices from
\$250/to 4 hrs

In Home Kitchen Planning service

One of our approved kitchen planners will help you to design your dream kitchen. We can assist you in planning at one of our stores free of charge, or for \$250 we can arrange an In Home Planning service visit up to 4 hours long.



Prices from
\$99/cabinet

Kitchen Installation service

Professional installation, tailored to your needs, at a competitive price. Especially handy for trickier jobs such as sinks, faucets, countertops and appliances.



Prices from
\$79

Assembly service

Our independent, professional partners can assemble your products for you.



Prices from
\$75

Kitchen Measuring service

We can measure your kitchen to help you plan your project quickly and accurately.



For more about our services, please see [IKEA.ca/services](https://www.ikea.ca/services) or talk with us in store.



Secure it!

Creating safer homes together

We all want our homes to be a safe place. When we work together, we can reduce the risk of accidents.

When it comes to our homes, safety is paramount. That's why IKEA has created products with a focus on both safety and quality. By working together, we can help prevent accidents and make every home a safer place for our children.

Some helpful tips for a safer home:

- 1** Furniture with included restraints must be secured to the wall according to product assembly instructions.
- 2** Always place heavy objects in the lowest drawers.
- 3** Remember to never put a TV or other heavy objects on top of a chest of drawers or any furniture not intended for use with a TV.
- 4** Never let children climb or hang on drawers, doors or shelves.

To request your own Secure it! Safety Kit, please go to your local IKEA store's Returns and Exchanges Department, call 1 (866) 866-4532 or visit [IKEA.ca/SaferHomesTogether](https://www.ikea.ca/SaferHomesTogether)

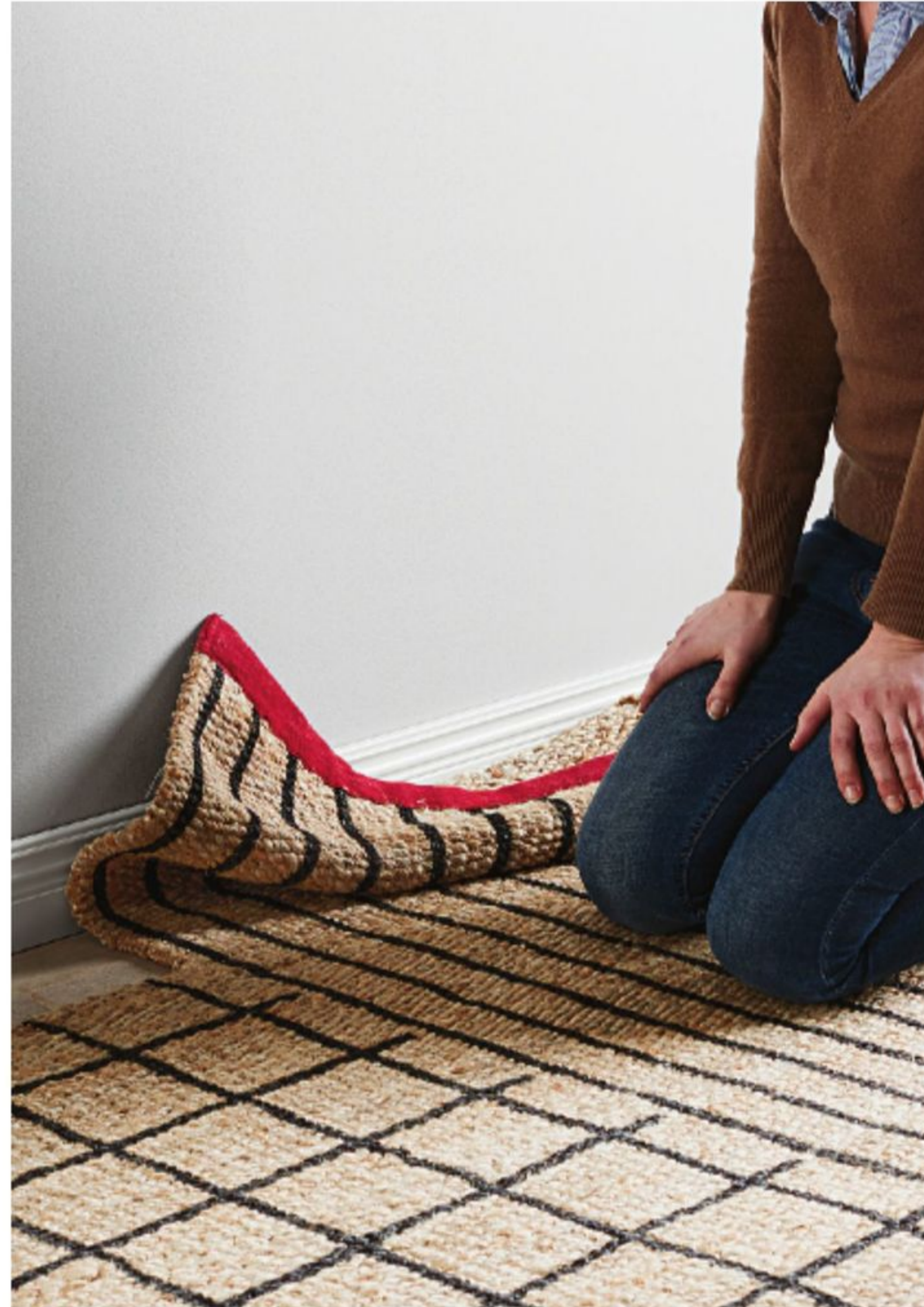

Return policy – 45 days to change your mind*

Changed your mind or are not satisfied with your purchase? Simply return the unused item within 45 days for an exchange or refund. A receipt and the original packaging are required for all returns and exchanges. Refunds will be issued in the same method of payment as the original payment (credit card purchases will be credited to the original credit card account).

We do not accept returns on:

- Used/washed bedding (all bed linens, duvets, pillows and pillow-tops)
- Any mattress or stuffed/upholstered product without a law label
- Cut fabrics
- Custom countertops
- Any product that has been modified/altere/washed
- AS-IS products
- IKEA gift cards

At any time, your local IKEA store reserves the right to refuse a return or exchange. Government photo ID may be required. Please see your local store for complete details. Services performed such as Delivery, Assembly, and Installation are not refundable. For online orders, IKEA will not assume transport charges for any items returned, unless specifically agreed upon beforehand for products purchased online.

Mattress returns policy*

It is important to us that you love your new mattress. So, if after a few weeks you discover that it is too firm, too soft, or too something else - just bring it back with your original receipt within 90 days and we will exchange it for one that suits you better. And there's no rush. You have 90 days to sleep on it! Please note that we are unable to exchange your mattress if the merchandise is found to be dirty, stained, damaged, or abused. Please see in-store for details. When you've found the perfect match, you can sleep easy with a free 25-year warranty.

Cancellation policy*

We can't cancel orders for made-to-specification countertops after they've been confirmed.

*This policy is in addition to your statutory rights.

But what about...?

If you still have questions, we want to make sure that you get a quick answer.

FAQ

Read the FAQ's at [IKEA.ca](https://www.ikea.ca) - they might answer your question:
[IKEA.ca/FAQ](https://www.ikea.ca/FAQ)

In Person

Speak to us in store - those friendly people in the yellow shirts are ready to help you through your buying decisions.

Twitter or email

Tweet us: [@IKEACASupport](https://twitter.com/IKEACASupport)
We always try to respond within 3 hours. Send us an email or write to us at: [IKEA.ca/contactus](https://www.ikea.ca/contactus)
We always try to respond within 24 hours.

Phone

If you ever need to talk to us in person, we're happy to answer your call. You can reach us over the phone at **1-866-866-IKEA (4532)**

Where to find your store

Stores

IKEA Boucherville

586 de Touraine
Boucherville, QC J4B 5E4
For more information and hours:
[IKEA.ca/Boucherville](https://www.ikea.ca/Boucherville)

IKEA Burlington

1065 Plains Road East
Burlington, ON L7T 4K1
For more information and hours:
[IKEA.ca/Burlington](https://www.ikea.ca/Burlington)

IKEA Calgary

8000 11th Street SE
Calgary, AB T2H 3B2
For more information and hours:
[IKEA.ca/Calgary](https://www.ikea.ca/Calgary)

IKEA Coquitlam

1000 Lougheed Highway
Coquitlam, BC V3K 3T5
For more information and hours:
[IKEA.ca/Coquitlam](https://www.ikea.ca/Coquitlam)

IKEA Edmonton

1311 102 Street NW
Edmonton, AB T6N 1M3
For more information and hours:
[IKEA.ca/Edmonton](https://www.ikea.ca/Edmonton)

IKEA Etobicoke

1475 The Queensway
Etobicoke, ON M8Z 1T3
For more information and hours:
[IKEA.ca/Etobicoke](https://www.ikea.ca/Etobicoke)

IKEA Montréal

9191 Cavendish Blvd
Montréal, QC H4T 1M8
For more information and hours:
[IKEA.ca/Montreal](https://www.ikea.ca/Montreal)

IKEA North York

15 Provost Drive
North York, ON M2K 2X9
For more information and hours:
[IKEA.ca/NorthYork](https://www.ikea.ca/NorthYork)

IKEA Ottawa

2685 Iris Street
Ottawa, ON K2C 3S4
For more information and hours:
[IKEA.ca/Ottawa](https://www.ikea.ca/Ottawa)

IKEA Richmond

3320 Jacombs Road
Richmond, BC V6V 1Z6
For more information and hours:
[IKEA.ca/Richmond](https://www.ikea.ca/Richmond)

IKEA Vaughan

200 Interchange Way
Vaughan, ON L4K 5C3
For more information and hours:
[IKEA.ca/Vaughan](https://www.ikea.ca/Vaughan)

IKEA Winnipeg

500 Sterling Lyon Parkway
Winnipeg, MB R3P 1E7
For more information and hours:
[IKEA.ca/Winnipeg](https://www.ikea.ca/Winnipeg)

Pick-up and order points

Kitchener

130 Gateway Park Drive
Kitchener, ON N2P 2J4
For more information and hours:
[IKEA.ca/Kitchener](https://www.ikea.ca/Kitchener)

London

3198 Wonderland Road S
London, ON N6L 1A1
For more information and hours:
[IKEA.ca/London](https://www.ikea.ca/London)

St. Catharines

285 Geneva Street
St Catharines, ON L2N 2G1
For more information and hours:
[IKEA.ca/StCatharines](https://www.ikea.ca/StCatharines)

Quebec City

3111 Avenue Watt
Quebec City, QC G1X 3W2
For more information and hours:
[IKEA.ca/QuebecCity](https://www.ikea.ca/QuebecCity)

Whitby

1650 Victoria Street E
Whitby, ON L1N 9L4
For more information and hours:
[IKEA.ca/Whitby](https://www.ikea.ca/Whitby)

Windsor

4155 Walker Road
Windsor, ON N8W 3T6
For more information and hours:
[IKEA.ca/Windsor](https://www.ikea.ca/Windsor)



**IKEA®
FAMILY**

**IKEA FAMILY
Member price**

01 **New SLADDA Bicycle**
\$599

Regular price: \$999



Forget the car – you can customize the SLADDA bike with the accessories you want for smoother, healthier, cost-free trips around town. Advanced features, such as automatic gears and a belt drive instead of an oily chain, mean that maintenance is minimal. So this might be the only urban transportation system that you need for an easier everyday life.

SLADDA series in stores October 2016

New SLADDA series. Powder coated aluminum.

01 Bicycle \$999. FAMILY member price: \$599.
Designer: O Juhlin/J Puranen/K Eke. RA. L175×H110cm.
Wheel size 26" 303.267.28 Wheel size 28" 603.267.36

02 Front rack \$45. FAMILY member price: \$34.99.
Designer: J Jelinek/O Juhlin. RA. W40×D36×H13cm. 403.154.80

03 Rear rack. In stores October 2016
Designer: J Jelinek/O Juhlin. RA. L57×W16×H40cm. 003.154.82

04 Bicycle trailer \$329. FAMILY member price: \$259
Designer: Sarah Fager. RA. L148×W78×H90cm. Wheel size 20".
903.456.44

RA=REQUIRES ASSEMBLY

You can really go places with IKEA FAMILY

As a member, you enjoy lower prices on the entire IKEA FAMILY product range – like the new SLADDA bike. You can also look forward to savings in the IKEA Restaurant, Swedish Food Market and special monthly product offers throughout the store.

If you opt in to receive emails from us when you sign up to become a member, you'll hear about our latest news, events, offers and more. And your opinions are always important to us as they can shape the next chapter of the IKEA story, and might even help us create a new product.

Set the wheels in motion today!

You can join for free at IKEA.ca/FAMILY and in your local store.

Big Savings

Save every day on the entire IKEA FAMILY product range, plus more discounts in the store and in our Restaurant and Swedish Food Market.

Big Fun

Every time you swipe your membership card at an in-store IKEA FAMILY kiosk, or make a purchase and use your card, you're automatically entered into a monthly sweepstakes for a chance to win a \$100 IKEA gift card!

Big News

If you sign up to receive emails from us, you'll get lots of info filled with ideas and inspiration.



Unlocking opportunities for kids through play

▼ Dive deeper into our features by downloading the IKEA Catalogue app.

The genuine glee on a kid's face when they play with a great toy – one that captures the imagination and sparks creativity – is universal. Rich or poor, northern hemisphere or southern, a great toy opens up the mind and heart. And it's why play is being used in places like the Comoros islands as a safe and powerful way to teach kids the skills that prepare them for school – and beyond.

The Comoros is an archipelago nation in the Mozambique Channel that few have heard of. The islands are naturally breathtaking, yet it's one of the poorest countries in Africa. Here, toys are resources that simply aren't available for all children as they are in wealthier nations. But with the help of IKEA Foundation and UNICEF, kids here and in emergency settings around the globe are playing their way to becoming capable and confident individuals thanks to Early Childhood Development (ECD) kits.

The size of a large suitcase, the 159 UNICEF ECD kits in the Comoros are colourful and exciting treasure boxes that include IKEA toys carefully selected by UNICEF to teach vital life skills to kids between the ages of three and six. It's an important age for

learning the cognitive and social skills that will help them succeed in school.

"Play is the easiest way to stimulate this kind of learning and development," says Julika Riegler, IKEA Foundation's communications liaison with UNICEF. "It's how a human develops. We learn through touching things, interacting with our peers, identifying things with our eyes, recognizing colours and counting."

The IKEA Foundation-donated toys in the kits are timeless, the kind that even our grandparents might remember having. Hand puppets that teach kids how to communicate with peers and express themselves; shape sorters that teach fine-motor skills and cooperation; and coloured paper and scissors that stimulate creativity. >>

The Kit



The kit is made up of 43 items that include toys and hygiene products.

Project in numbers

- IKEA Foundation has donated eight IKEA toys for 12,000 ECD kits
- More than 1.2 million children will benefit from the ECD kits with IKEA toys
- More than 7,000 children are benefitting from ECD kits in Comoros



The ECD kits are the brainchild of UNICEF, as part of their effort to make early childhood education, stimulation and growth a right for all children. It's a goal that IKEA Foundation shares, which is why they were happy to donate enough IKEA toys to eventually reach more than 1.2 million kids.

The kits are used in conflict areas like Syria and Lebanon, and places like the Comoros that lack the structure and resources to educate kids in ways that encourage emotional learning, creativity, as well as develop their cognitive and motor skills.

"Teachers now have the tools that help them engage nursery school children in a more active way," says Miriam Mareso, the Chief of Education for UNICEF Comoros. "The toys help to enable learning through creativity and the interaction between children. These are important factors that help prepare children for what they will experience in primary school."

Working with the local government in the Comoros, UNICEF introduced the ECD kits along with a training program to guide teachers on how to teach through play – and the results are pretty touching.

"The kids are very happy and they play a lot so everyone is running to be the first to take the kits," says Hadidja Youssoufi Chanfi, a nursery school teacher at Vouvouni Primary School, just outside of the capital of Moroni. "Everyone is saying: 'this is for me' and 'this is for me.' And it makes them very active and more participative."

Parents have also noticed the way this new approach to learning has excited, motivated and energized their children.



Left | Teacher Hadidja Youssoufi Chanfi demonstrates to students how to role-play using IKEA hand puppets.



Below | Students at the Vouvouni Primary School play with colourful building blocks, characterful hand puppets, and a sort-and-stack set.



"I've seen a lot of change because he's repeating a lot of things on the blackboard at home that he learns in school," says Hadjira Hamidou, the mother of a four-year-old boy named Outhaimine at the Vouvouni Primary School. "He is drawing a moon and a sun the way the teacher is showing them. It gives him a good spirit."

UNICEF has already found that the kids who benefit from early childhood development programmes are more successful in school and have a lower drop-out rate, a particular problem in poor communities.

"Children identify school with fun and that keeps them in school," Julika says. "This is a way to unlock opportunities for kids to develop into young adults, who have the opportunity to study, start businesses, have an income, and support their own children and families later. That's the long-term growth that education and play can bring." ■

Above | A roll of paper is a blank canvas that allows the imagination to take over, while scissors help kids create all kinds of shapes out of coloured paper.

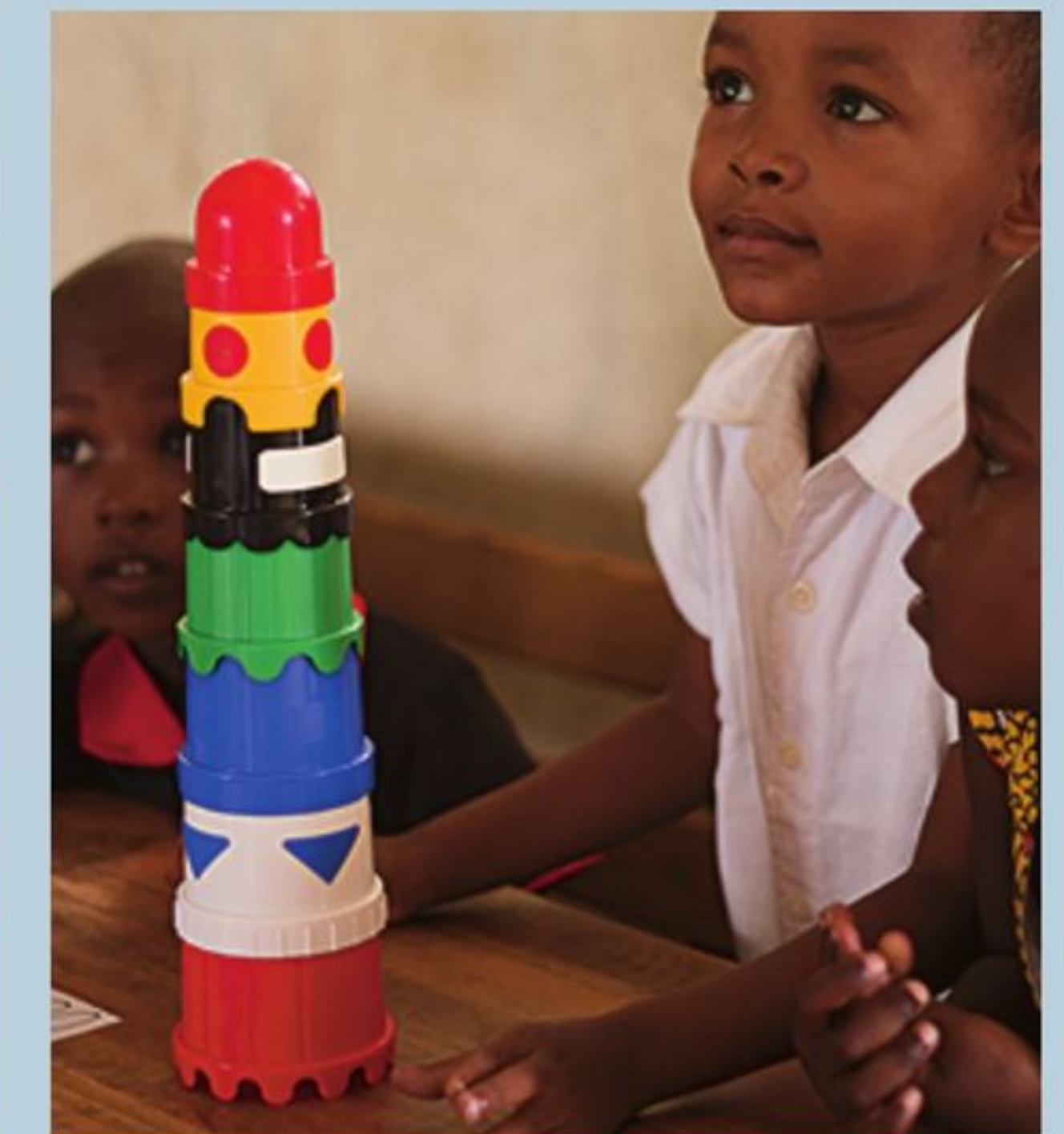

The IKEA FOUNDATION is the philanthropic arm of INGKA Foundation, the owner of the IKEA Group of companies. The IKEA Foundation aims to improve opportunities for children and youth in some of the world's poorest communities. By working with strong strategic partners like UNICEF, the IKEA Foundation can apply innovative approaches to achieve large-scale results in a child's life. UNICEF promotes the rights and well-being of every child by focusing special effort on reaching the most vulnerable and excluded children, to the benefit of all children, everywhere.

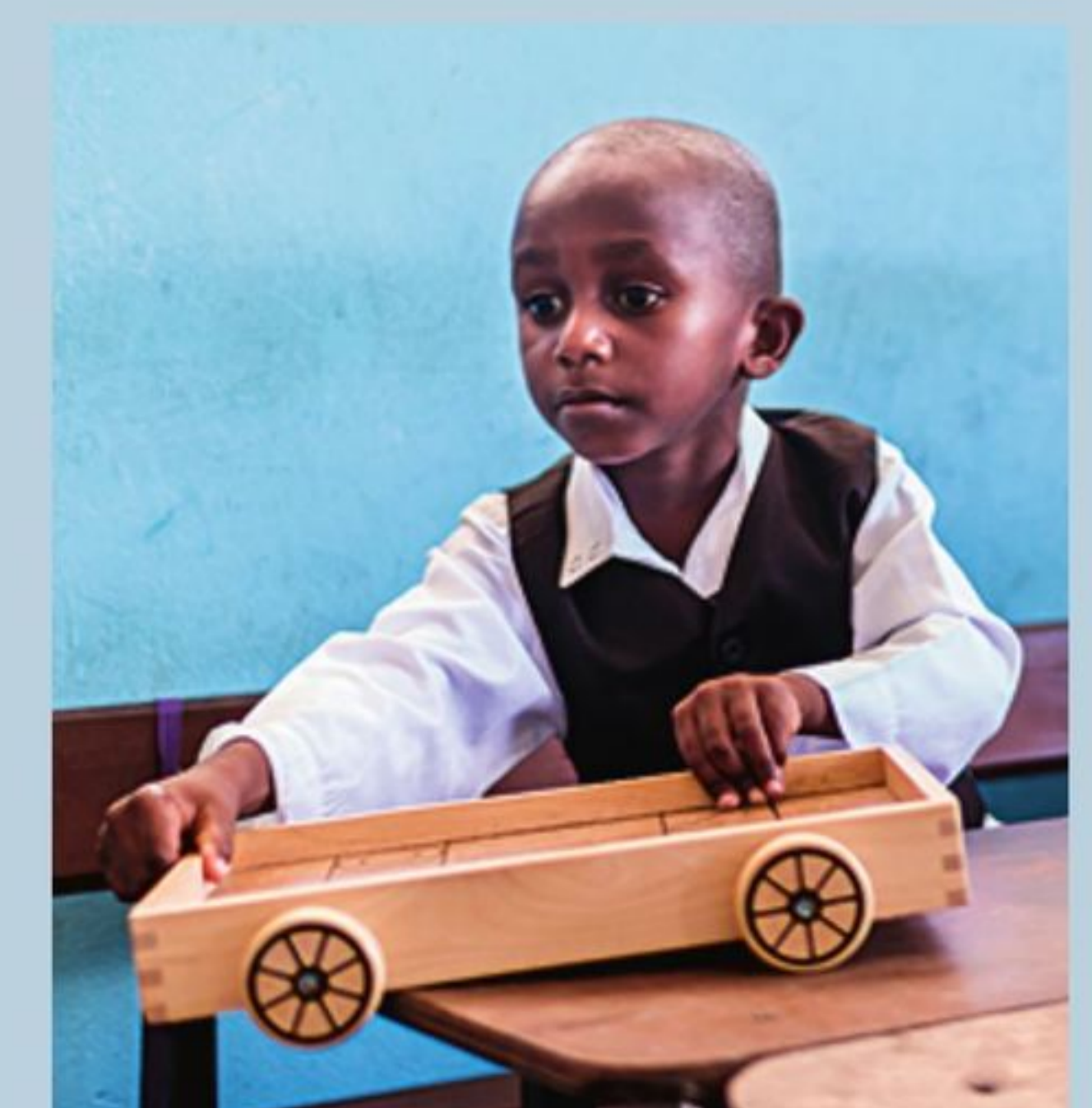



We're for helping kids appreciate how nature nourishes

IKEA believes that children are the most important people in the world, and that's why we'll support childhood development across Canada.

We know that a strong connection with nature helps children to develop in a variety of important ways. So, on National Tree Day in September 2015, we worked with our long-standing partners Tree Canada to host well over 1000 school children across the country to get outside, explore their surroundings, be creative, and experience the wonder of nature.

IKEA Canada co-workers were on hand in each of the communities around our stores to help the students enjoy an eco-system scavenger hunt, play a "tree-via" game, create wooden medallion necklaces, and

plant trees in clay pots to take home to nurture. In the future, IKEA Canada will continue to work with partners in our local communities to enable youth to experience the greatness of the great outdoors and understand how the natural world nourishes us.

Read more at IKEA.ca/NatureNourishes

#NatureNourishes

Warranties

General conditions

FREE
2
Year
Warranty

FREE
5
Year
Warranty

FREE
10
Year
Warranty

FREE
15
Year
Warranty

FREE
25
Year
Warranty

What is Warrantied?

The extent of the warranty given for each product is described alongside each product on pages 322-324.

Duration of Warranty

Each warranty lasts for the number of years stated against each product starting from the date of purchase.

What will IKEA do to correct the problem?

IKEA will examine the product and decide if it's covered under this Warranty. IKEA will then, at its choice, either repair the defective product or replace it with the same or a comparable product. In these cases, IKEA will be responsible for the costs of repairs, spare parts, labour and travel for repair staff that IKEA incurs, provided that the product is accessible for repair without IKEA incurring additional expenditure to gain access. This will not apply in cases where repair work has not been authorized by IKEA. Any defective parts removed in the course of repair work will become the property of IKEA. If the item is no longer sold by IKEA, IKEA will provide an appropriate replacement. IKEA will decide at its discretion, what will constitute an appropriate replacement.

Conditions for the Warranties

The warranties are valid from the date of purchase at IKEA. The original purchase receipt is required as proof of purchase.

Exclusions

The warranties do not apply to products that have been stored or assembled incorrectly, used inappropriately, abused, misused,

altered, or cleaned with wrong cleaning methods or wrong cleaning products. The warranties do not cover wear and tear, cuts or scratches, or damage caused by impacts or accidents. The warranties do not apply if products have been placed outdoors or in a humid environment or if the products have been used for non-domestic purposes (unless otherwise stated). The warranties do not cover consequential or incidental damages.

Care instructions

To be able to rely on this warranty you need to follow the specific care instructions for every product.

► You will find all care instructions in the IKEA stores and on the IKEA web site: www.IKEA.ca

General legal rights

This warranty gives you specific legal rights. This warranty does not, in any way, affect the rights given to you by law. You may also have other rights under applicable provincial/territorial law. IKEA is not responsible for incidental or consequential damages, or limitations within the warranties, so these exclusions or limitations may not apply to you.

How to reach us if you need service

Contact your local IKEA store. You will find the phone numbers on page 313 of this catalogue or at www.IKEA.ca.

In the case of "for IKEA by Whirlpool" products, contact the service team at Whirlpool Customer Care Centre directly at 1-866-664-2449. Save your sales receipt as proof of purchase. Proof of purchase is required for the warranty to be valid.

► To find out more, pick up the warranty folders at your local store.

Special Information

This catalogue has been prepared by IKEA. Sources of supply and specifications are subject to change. Every reasonable effort will be made to ensure that all advertised merchandise is available in adequate supply. A high standard of accuracy has been sought in the preparation of this catalogue. Errors and omissions are always a possibility. Although IKEA cannot be held responsible, upon the discovery of any errors or omissions, all reasonable steps will be taken to inform IKEA Customers. Find more information at IKEA.ca.

Country of origin

For all of our products, we choose specialized manufacturers who can produce our components at the most economical prices. A single item may consist of several components from different countries. Country of origin information is available on each component when you pick it up.

New

This appears on products that are new to the IKEA catalogue for this year. New products continue to arrive all the time, so visit the store often!

NEW LOWER PRICE

This appears on products with a New Lower Price as compared to the 2016 catalogue.

Specific product conditions



SEKTION kitchen system
25 Year Warranty

What products are covered under this warranty?

This warranty applies to domestic kitchen use only. This warranty covers all of the following parts of the SEKTION kitchen system:

- Cabinet frames • Doors and drawer fronts
- UTRUSTA hinges • MAXIMERA fully-extending drawers • UTRUSTA shelves of tempered glass and melamine • Plinths • Legs • Cover panels
- Deco strips/mouldings • Pre-cut countertops except LILLTRÅSK • Sinks except FYNDIG
- VÅGLIG connecting rail • UTRUSTA connecting rail for fronts.

Products not covered under this warranty:

Knobs, handles, LILLTRÅSK countertop, FÖRVARA drawers, UTRUSTA wire baskets, TUTEMO and HÖRDA open cabinet have a 10-year warranty.

See also general conditions in the warranty folder for SEKTION Kitchen System.

Appliances

5 Year Warranty

What is covered under this warranty?

The warranty covers faults of the appliance, which can be proved to have been caused by faulty construction or material faults from the date of purchase from IKEA. This warranty applies only when this major appliance is operated and maintained according to instructions attached to or furnished with the product. This warranty applies to domestic use only. Whirlpool Canada LP

(hereafter "Whirlpool") will pay for Factory Specified Parts and repair labour to correct defects in materials or workmanship. Within the warranty period, the costs to remedy the fault e.g. repairs, parts, labour and travel will be covered, provided that the appliance is accessible for repair without special expenditure. Replaced parts become the property of IKEA. The exceptions are specified under the headline "What is not covered under this warranty?"

How long is the warranty valid?

This warranty is valid for five (5) years from the original date of purchase of the IKEA appliance from IKEA. If service work is carried out during the warranty period, this will not extend the warranty period for the appliance, or the new parts.

Which appliances are covered under this warranty?

The five (5) year warranty is valid for all IKEA appliances, except for LAGAN appliances, which have a 1 year warranty.

Who will execute the service?

Whirlpool, through its own service operations or authorized service partner, will at its sole discretion, either repair the defective product or replace it with the same or a comparable product. In these cases, Whirlpool will be responsible for the costs of repairs, spare parts, labour and travel for repair staff that Whirlpool incurs, provided that the product is accessible for repair without Whirlpool incurring additional expenditure to gain access. This will not apply in cases where repair work has not been authorized by Whirlpool (or its authorized service partner).

What is not covered under this warranty?

Service calls to correct the installation of your major appliance, to instruct you on how to use your major appliance, to replace or repair house fuses, or to correct house wiring or plumbing is not covered. Service calls to repair or replace appliance light bulbs, air filters or water filters. Consumable parts are excluded from warranty coverage. Repairs when your major appliance is used for other than normal, single-family household use or when it is used in a manner that is contrary to published user or operator instructions and/or installation instructions. Damage resulting from accident, alteration, misuse, abuse, fire, flood, acts of God, improper installation, installation not in accordance with electrical or plumbing codes, or use of consumables or cleaning products not approved for use. Cosmetic damage, including scratches, dents, chips or other damage to the finish of your major appliance, unless such damage results from defect in materials or workmanship and is reported within 30 days from the date of purchase. Any food loss due to refrigerator or freezer product failures. Costs associated with the removal from your home of your major appliance for repairs. This major appliance is designed to be repaired in the home and only in-home service is covered by this warranty. Repairs or parts or systems resulting from unauthorized modifications

made to the appliance. Expenses for travel and transportation for product service if your major appliance is located in a remote area where service by an authorized servicer is not available. The removal and reinstallation of your major appliance if it is installed in an inaccessible location or is not installed in accordance with published installation instructions. Major appliances with original model/serial numbers that have been removed, altered or cannot be easily determined. This warranty is void if the factory applied serial number has been altered or removed from your major appliance. The cost of repair or replacement under these excluded circumstances shall be borne by the customer. Transportation damages are not covered under this warranty. If a customer transports the product to their home or other address themselves, IKEA is not liable for any damage that may occur during transport. However, in case of IKEA delivery of the product to the customer's delivery address, then eventual damages to the product that occurs during this delivery will be covered by IKEA (but not under this warranty). For claims under this last particular condition the customer should contact the IKEA store where the original purchase was made.

Kitchen faucets

10 Year Warranty

What is covered under this warranty? The 10 year warranty is valid for all kitchen faucets at IKEA. This warranty covers defects in material and workmanship. This warranty applies to domestic use only.

What is not covered under this warranty?

This warranty does not cover normal wear and tear, cuts or scratches, or damage caused by impacts, accidents or waterborne debris, or if the products have been used in a corrosive environment.

See also general conditions in the warranty folder for faucets.

Sofas

10 Year Warranty

What is covered under this warranty?

This Warranty applies to domestic use only and covers defects in material and workmanship in • frames • seat and back cushions in the following products:

- EKTORP seating series • KARLSTAD sofa • KIVIK seating series • KNISLINGE seating series • LANDSKRONA seating series • NOCKEBY seating series • STOCKHOLM seating series • STOCKSUND seating series • SÖDERHAMN seating series • TIDAFORS seating series • TIMSFORS seating series • KLIPPAN 2-seat sofas • KNOPPARP 2-seat sofa • EKENÅS armchair and footstool • POÅNG armchairs and footstool • EKERÖ armchair • MELLBY armchair • NOLBYN armchair • NOLMYRA armchair • NORSBORG

seating series • SKOGABY seating series • STRANDMON armchair • VALLENTUNA seating series.

Parts and products not covered under this warranty: This warranty does not apply to:

- Fabric covers • Leather covers • TULLSTA
- JENNYLUND armchair • MUREN armchair
- POÅNG cushions • POÅNG children's armchair • VALENTUNA seat module with bed

PAX/KOMPLEMENT

10 Year Warranty

What is covered under this warranty?

This warranty covers defects in material and workmanship in the following components of the PAX/KOMPLEMENT wardrobes and interior fittings from the date of purchase from IKEA. • Frames • Hinged doors and hinges • Dividers for frames, shelf inserts and sectioned shelves • Sliding doors and sliding door mechanism • KOMPLEMENT interior organizers.

Products not covered under this warranty:

KOMPLEMENT insert for pull-out tray, KOMPLEMENT jewellery insert for pull-out tray, KOMPLEMENT divider for pull-out tray and KOMPLEMENT tray 3-pack.

GODMORGON

10 Year Warranty

What is covered under this warranty?

This warranty applies to domestic use only and covers defects in material and workmanship in the following furniture: GODMORGON furniture, GODMORGON legs, ODENSVIK ceramic sink, BRÄVIKEN and EDEBOVIKEN crushed marble sinks and included watertrap, GODMORGON storage unit set of 3, box with compartments, box with lid, storage with compartments.



What is not covered under this warranty?

The warranty does not apply to ALDERN counter tops.

Bathroom sinks

10 Year Warranty

What is covered under this warranty?

This Warranty applies to domestic use only and covers defects in material and workmanship in all



bathroom sinks including water trap.

What is not covered under this warranty?

This warranty does not apply to products that have been stored, assembled or installed incorrectly, used inappropriately, or cleaned with wrong cleaning methods or wrong cleaning products. This Warranty does not apply if the products have been used for public use or outdoors.

Bathroom faucets

10 Year Warranty

What is covered under this warranty?

This warranty applies to domestic use only and covers defects in material and workmanship in all bathroom faucets.

What is not covered under this warranty?

The included aerator, which is an expandible item and any damage caused by waterborne debris are not covered by this warranty.

Mattresses

25 Year Warranty

What is covered under this warranty?

This warranty covers defects in material and workmanship in the following components of the mattresses and/or bed bases described below from the date of purchase from IKEA. The original receipt is required as proof of purchase. • Springs in spring mattresses • Foam core in foam mattresses • Latex core in latex mattresses • Wooden frame and slats in slatted bed bases • Electric motor in electrically operated beds (5 year warranty). This warranty applies to domestic use only.

What is not covered under this warranty:

All mattress toppers: SULTAN TORÖD, SULTAN TJÖME, SULTAN TAFJORD, TROFORS; slatted bed base SULTAN LADE and JÖMNA mattresses. Children's mattresses and sofa bed mattresses.

BEKANT and GALANT desk series and storage system

10 Year Warranty

What is covered under this Warranty?

The Warranty covers defects in materials, workmanship and function on all main parts in the BEKANT desk series and GALANT storage system.

What products are not covered under this warranty?

The following product in the BEKANT desk series and GALANT storage system is not covered under the Warranty: • BEKANT desk top shelf • BEKANT screens.

MARKUS, VOLMAR

10 Year Warranty

What is covered under this warranty?

This Warranty covers defects in material and workmanship on the following components:

- The structural frame • Moving parts.

SENSUELL pots and pans

25 Year Warranty

Valid for all pots and pans in SENSUELL series.

What is covered under this Warranty?

This warranty applies to domestic use only and is valid provided that the care instructions provided are followed. This warranty covers function, materials and workmanship in all above listed series. The Warranty covers: • Stability of the base • Washing in a domestic dishwasher.

What is not covered under this warranty?

This warranty does not cover changes in the appearance of the cookware unless they have a significant effect on function

SENIOR pots and pans

25 Year Warranty

Valid for all pots and pans in SENIOR series.

What is covered under this warranty?

This warranty applies to domestic use only and is valid provided that the care instructions provided are followed. This warranty applies to domestic use only and covers defects in material and workmanship in all SENIOR cookware products. The warranty covers the base of the cookware. We guarantee that the base will retain its shape and therefore its heat conducting qualities. The warranty is valid if you wash your cookware by hand.

What is not covered under this warranty?

This warranty does not cover changes in the appearance of the cookware unless they have a significant effect on function.

Specific product conditions

IKEA 365+ pots and pans

15 Year Warranty
Valid for all pots & pans without non-stick coating.

5 Year Warranty

Valid for all pots & pans with non-stick coating.

What is covered under this warranty?

This warranty covers function, materials and workmanship in all cookware in the above listed series. The warranty is valid if you wash your cookware by hand. The warranty covers:

- Stability of the base
- Non-stick properties on non-stick "pans".

What is not covered under this warranty?

This warranty does not cover changes in the appearance of the cookware unless they have a significant effect on function.

VARDAGEN pots

15 Year Warranty

What is covered under this warranty?

This warranty covers function, materials and workmanship in all cookware in the above listed series. The warranty is valid if you wash your cookware by hand. The warranty covers:

- Stability of the base

What is not covered under this warranty?

This warranty does not cover changes in the appearance of the cookware unless they have a significant effect on function.

TROVÄRDIG frying pans

10 Year Warranty

What is covered under this warranty?

This warranty covers function, materials and workmanship in all cookware in the above listed series. The warranty covers:

- Stability of the base
- Non-stick properties.

What is not covered under this warranty?

This warranty does not cover changes in the appearance of the cookware unless they have a significant effect on function.

IKEA 365+ knives

15 Year Warranty
Valid for all knives in IKEA 365+ series.

What is covered under this warranty?

This warranty covers function, materials and workmanship in all knives in the IKEA 365+ knives series. This means that, in normal domestic use and provided that our care instructions are followed, the knives will still work as well as they did when they were new, even after 15 years. In this instance, normal use is defined as using (for cutting food) and cleaning the knife by hand once a day and regular sharpening. • Sharpness of the knife. The knife shall be sharp when you buy it and you will be able to keep it sharp so it can function properly, every day. The knife blade is made of a steel that is hardened so that it is possible to sharpen the knife to original sharpness anytime during the warranty period. • Durable handle. The handle of the knife should not crack, break or come loose from the blade so that the knife is not possible to use. • That there will not be any corrosion on the knife blade.

What is not covered under this warranty?

This warranty does not cover changes in the appearance of the knife unless they have a significant effect on function.

SLADDA bicycle

10 Year Warranty - Valid for belt drive.
25 Year Warranty - Valid for bicycle frame.

What is covered under this warranty?

This warranty applies to standard use on paved roads and cycle paths and covers defects in material and workmanship of:

- The belt drive
- The bicycle frame.

What is not covered under this warranty:

This warranty does not apply to any other parts or components of SLADDA and only applies to the belt drive and bicycle frame. To replace parts (e.g. worn brake pads or broken parts from an accident) please call IKEA Customer Service or contact your local IKEA store. Use only genuine original replacement parts. If you use anything other than genuine replacement parts you may compromise the safety of your bicycle.

What's included in the price?

SEKTION kitchen system

SEKTION kitchen system is the foundation in all of our built-in kitchens. Based on frames - sturdy base cabinets, wall cabinets and high cabinets in numerous depths, heights and widths - SEKTION allows you to create exactly the kitchen you want. Use the SEKTION buying guide to get in-depth knowledge about the system; how to build it, all the parts and prices. Download it today at IKEA.ca/kitchen, or get a copy at the IKEA store.

Two prices make it easier to compare

For every kitchen we present in this brochure, you'll see two prices. The first indicates the price of the total combination shown in the floor plan on the page, while the second one relates to the linear foot price of a standard 10x10' kitchen in the door style presented in the picture.

Combination price

The combination price includes: cabinets, door fronts, drawers and drawer fronts, interior shelving, hinges, cover panels, toekicks and egs. Countertops and appliances are listed separately. Sink, faucet, handles and lighting are sold separately.

Linear foot price

The linear foot price includes: cabinets, door fronts, drawers and drawer fronts, interior shelving, hinges, cover panels, toekicks and legs. Sink, faucet, handles, appliances, countertop and lighting are sold separately.



GREAT PLACE TO WORK

IKEA Canada is growing from coast to coast, and the opportunities are endless!

Where do you see yourself?

At IKEA, you decide how your career develops. We believe in everyone and their own unique talents, and we will provide you with development opportunities to shape the career you want. In time, your interests might find you in a different area of the company or even in another part of the world!

At IKEA we all share one passion - to create a better everyday life for as many people as possible....and we are always looking for people who share our passion and want to grow with us.

Please visit IKEA.ca/careers to view our current vacancies and to find out more about rewarding careers at IKEA.



The IKEA catalogue is printed on FSC® certified paper to ensure more sustainable origins of the wood.



Index

- A**
 Armchairs..... 228
- B**
 Baby 296
 Bathroom accessories 278
 Bathroom cabinets and storage .. 276
 Bathroom ideas..... 146
 Bathroom sink cabinets 276
 Bathroom textiles..... 280
 Bedroom ideas..... 124
 Beds 292
 Bed textiles 288
 Blankets and throws 284
 Bookcases 250-253
 Boxes and baskets 272
- C**
 Candles and candle holders 246
 Ceiling lamps 216
 Changing tables and nursing 297
 Chest of drawers 268
 Charging 210
 Children (age 3-7)..... 140, 298
 Children (age 8-12)..... 142, 300
 Children play..... 302
 Clocks 244
 Clothes and shoe storage 258
 Clothes Organizers 264
 Clothes storage system..... 258
 Coffee and side tables..... 230
 Cookware 174
 Coat racks 274
 Cribs 296
 Curtain rails and rods..... 232-237
 Curtains and blinds..... 232-237
 Cushions and cushion covers 232-237
- D**
 Decorative accessories 244
 Desks and tables 204
 Dining ideas..... 10
 Dining stools 200
 Dining chairs..... 196
 Dining tables..... 196
 Dinnerware..... 186
 Duvets..... 284
 Duvet covers 284
- E**
 Entrance..... 270
- F**
 Fabrics 232
 Floor lamps..... 212
 Food at IKEA 70
 Food storage
 and organizing 178
- G**
 Gift wrapping 247
 Glassware and jugs 186-191
 Growing 44, 172
- H**
 Hallways..... 270
 Highchairs 14, 197, 199
 Hooks and hangers..... 182, 274, 280
- I**
 IKEA Business..... 202
- K**
 Kitchen accessories..... 52, 182
 Kitchen appliances 32
 Kitchen ideas 32
 Kitchen islands and trolleys 180
 Kitchens - free standing 38
 Knives and
 chopping boards..... 174
- L**
 Lighting 212
- M**
 Mattresses 282
 Mirrors 268, 270
- N**
 News..... 6, 8
- O**
 Office chairs 204-209
 Organizing ideas 100
 Outdoor..... 45
- P**
 Pantry 64, 66
 Photo frames and art 244
 Pillows 284
 Plant pots and plants 79, 172
- Q**
 Quilts 284
 Quilt covers 284
- R**
 Relaxing ideas..... 74
 Rugs 238
- S**
 Serveware..... 190
 Shades, bases and cords..... 212
 Shelving units 250
 Sideboards and buffets 180
 Sleeping ideas..... 124
 Small storage..... 272
 Sofa beds 222
 Sofas 218
 Step stools and step ladders..... 278
 Storage boxes and baskets..... 272
 Storage cabinets 250
 Storage systems and units 250
- T**
 Table lamps 212
 Tableware..... 186
 Textiles 232
 TV and media storage..... 254
- V**
 Vases, bowls and flowers..... 248
- W**
 Wardrobes and
 bedroom storage..... 258
 Waste sorting..... 60, 184
 Work desk and chairs..... 204
 Workspace storage..... 204-209
- This is IKEA**
 Ways to shop 306
 Services 309
 Return Policy..... 312
 Contact Information 313
 IKEA FAMILY 314
 People & Communities 320
 Warranties..... 321
 Working with us 325
- Features**
 Food lovers of the future 48
 What makes a home a home..... 94
 Why good design
 is democratic 170
 Thinking inside the box 266
 What home is for a refugee
 without one..... 160
 Swedishness has no borders..... 120
 Furniture made out of
 paper. Really? 224
 When the sofa is the home 84
 It's so much more than
 meatballs 68
 Unlocking opportunities for kids
 through play 316
 The thing about quality -
 an interview with Jan Ahlsén..... 192
 The inspiring and utterly
 improvisational cooking style
 of Jonah Reider 26
 Stubbornness is a virtue 240
- You can see our range and the
 very latest products at IKEA.ca
 and in your local store.**



**Goodness
beyond flavour**

New SANDWICH
pulled salmon

\$4.99



© Inter IKEA Systems B.V. 2016. CAE
Printed in the USA on recyclable paper. Complimentary copy.

Our new hot-smoked salmon sandwich is made by using all of the prime meat from each fish – not just the fillets. Served up street-style in a sourdough bun, with green leaf salad, a sting of spicy BBQ glaze and pickled gherkins, it's as sustainable as it is tasty!

Served in the IKEA Restaurant as part of our chilled offer.

