

FORNEBY

DK

NL

GB

FR

DE

IT

NO

PT

ES



Design and Quality
IKEA of Sweden

DANSK	6
NEDERLANDS	10
ENGLISH	14
FRANÇAIS	18
DEUTSCH	22
ITALIANO	26
NORSK	30
PORTUGUÊS	34
ESPAÑOL	38

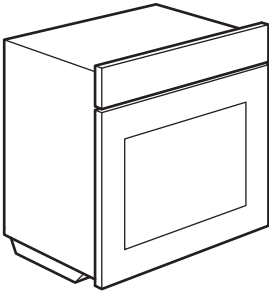
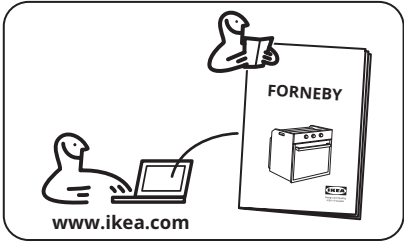
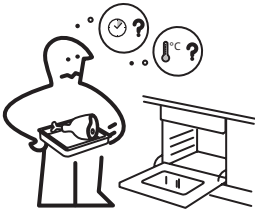

1x

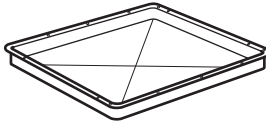

1x

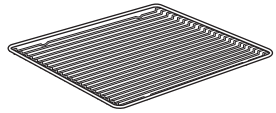

1x

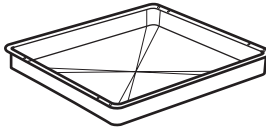

1x

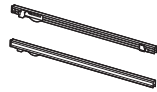

1x

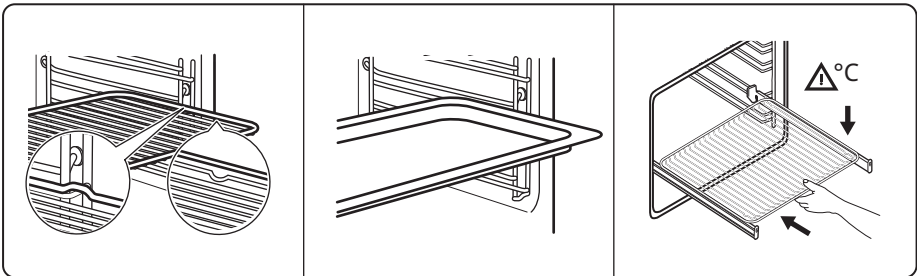

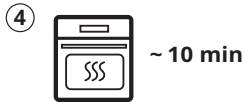
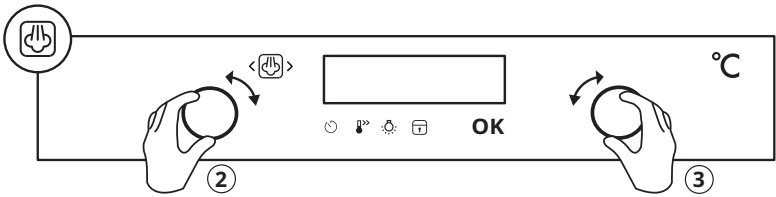
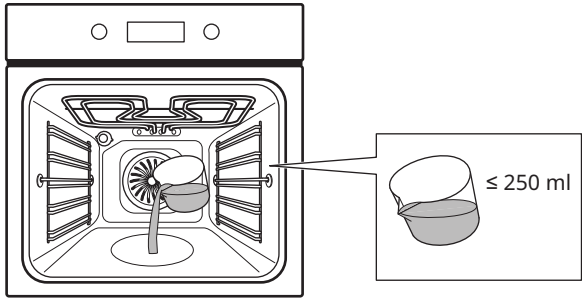
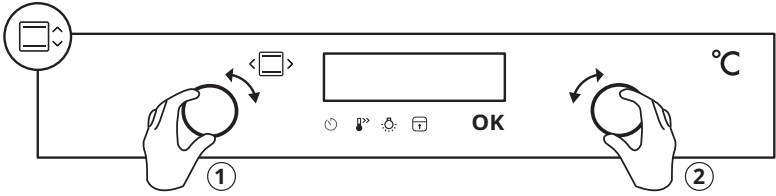
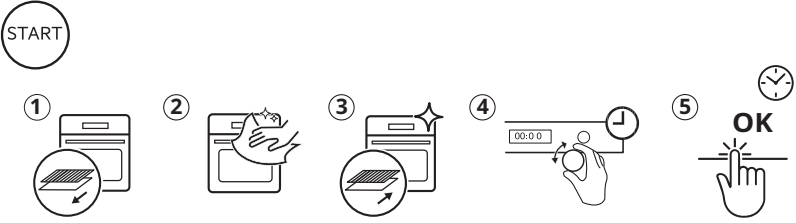



A 06:59 06:58 06:57 ... 00:00

B STOP START ●————● STOP ①

C START —● [shaded area] ● STOP

D 00:00 00:01 00:02 ...

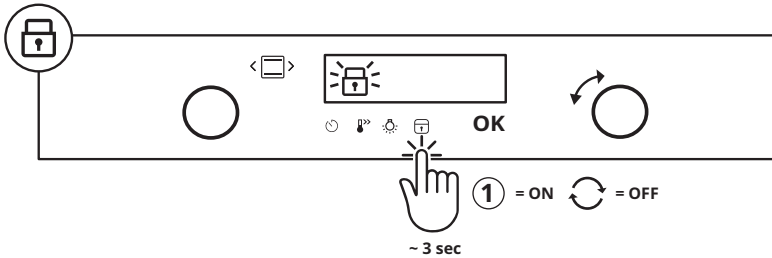
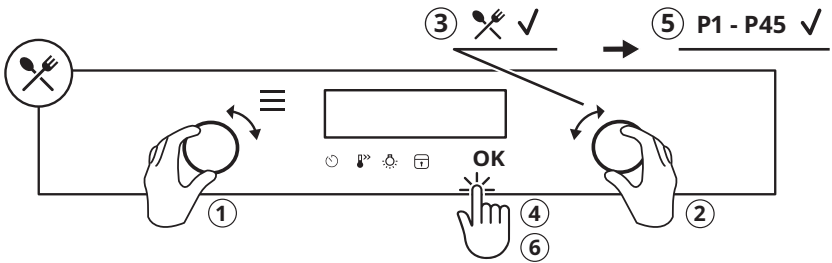

Produktbeskrivelse

Generelt overblik

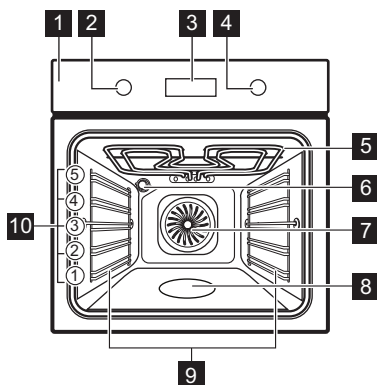

- 1** Betjeningspanel
- 2** Knap til ovnfunktioner
- 3** Skærm
- 4** Kontrolknap
- 5** Varmelegeme
- 6** Ovnpære
- 7** Blæser
- 8** Prægning i ovnrums
- 9** Ovnribbe, udtagelig
- 10** Ovnrriller

Betjeningspanel

Oversigt over betjeningspanel

Vælg en ovnfunktion for at tænde apparatet. Drej knappen for ovnfunktionerne til slukpositionen for at slukke for apparatet.

	Tryk for at indstille: Urfunktioner.
	Tryk på og hold den nede for at indstille funktionen: Hurtig opvarmning
	Tryk for at tænde eller slukke ovnpæren.
	Tryk på og hold den nede for at indstille funktionen: Lås
OK	Tryk for at bekræfte valget.

Displaylamper

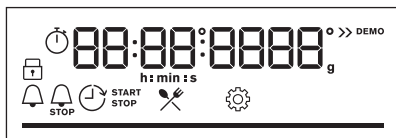

Display med vigtige funktioner.

	Apparatet er låst.
	Åbn menuen, og vælg det ikon, der skal åbnes: Hjælp til tilberedning.
	Åbn menuen, og vælg det ikon, der skal åbnes: Indstillinger
	Hurtig opvarmning er tændt.
	Tilberedning med damp er tændt.
	Minuter er tændt.
	Sluttid er tændt.
	Udskudt tid er tændt.
	Optimer er tændt.
	Bjælken er helt rød, når apparatet når den indstillede temperatur.

Daglig brug

Ovnfunktioner

	Varmluft: Jævn bagning, mørt kød, tørring
	Over-/undervarme: Traditionel bagning
	SteamBake: Dampning
	Frosne madvarer: Pommes frites, kartoffelbåde, forårsruller
	Pizza: Pizza-bagning
	Undervarme: Bagning af kager
	Fugtig varmluft: Bagning
	Grillstegning: Stegning, grillstegning
	Turbogrill: Stegning af kød, brunng
	Menu: For at åbne menuen.

Varmluft, Over-/undervarme: Når du indstiller temperaturen til under 80 °C, slukkes lampen automatisk efter 30 sekunder.

Bemærkninger til: Fugtig varmluft

Denne funktion blev anvendt til at overholde kravene i energieffektivitetsklasse og økodesign (i overensstemmelse med EU 65/2014 og EU 66/2014). Tests i overensstemmelse med:

IEC/EN 60350-1

Ovnlågen skal være lukket under tilberedningen, så funktionen ikke afbrydes, og ovnen kører med den højeste energieffektivitet, der er mulig.

Når du bruger denne funktion, slukkes lampen automatisk efter 30 sekunder.

Denne funktion er beregnet til at spare energi under madlavning. Når du bruger denne funktion, kan temperaturen i ovnrummet variere fra den indstillede temperatur. Varmeeffekten kan blive reduceret.

Hjælp til tilberedning

Displayet viser **P** og et **nummer** på retten, som du kan kontrollere i tabellen.

1	Roastbeef, rød
2	Roastbeef, rosa i midten
3	Roastbeef, gennemstegt
4	Steak, medium
5	Oksesteg/braiseret
6	Roastbeef, rød LTC*
7	Roastbeef, medium LTC*
8	Roastbeef, gennemstegt LTC*
9	Filet, rød LTC*
10	Filet, medium LTC*
11	Filet, færdig LTC*
12	Kalvesteg
13	Nakkesteg i nakkesteg
14	Pulled pork LTC*
15	Mørbrad, frisk
16	Spareribs
17	Lammeben med ben
18	Hel kylling
19	Halv kylling
20	Kyllingebryst
21	Kyllingelår, friske
22	And, hel
23	Gås, hel
24	Farsbrød
25	Hel fisk, grillstegt

26	Fiskefilet
27	Cheesecake
28	Æblekage
29	Æbletærte
30	Æbletærte
31	Brownies
32	Chokolademuffins
33	Brødkage
34	Bagte kartofler
35	Kartoffelbåde
36	Grillede blandede grøntsager
37	Kroketter, frosne
38	Pommes frites, frosne
39	Kød / grøntsagslamel med tørre nudeltallerkener
40	Kartoffelgratin
41	Pizza frisk, tynd
42	Pizza frisk, tyk
43	Quiche
44	Flute/ciabatta/hvidt brød
45	Fuldkornsbrød/rugbrød i brødform

*LTC - Lavtemperaturstegning

Ændring af indstillinger

- ☰ - vælg for at indtaste Menu.
- ⚙️ - vælg for at indtaste Indstillinger.
Tryk på OK.
- Drej knappen for at vælge indstillingen.
Tryk på: OK
- Juster værdien. Tryk på: OK
Drej knappen for ovenfunktionerne til slukpositionen for at forlade Menu.

Menu: Indstillinger

Displayet viser **0** og et **nummer** på indstillingen, som du kan kontrollere i tabellen.

	Indstilling	Værdi
1	Aktuel tid	Skift
2	Lysstyrke display	1 - 5
3	Panelsignal	1 - Bip, 2 - Klik, 3 - Lyd fra
4	Signal volume	1 - 4
5	Optimer	Tænd / sluk
6	Lys	Tænd / sluk
7	Hurtig opvarmning	Tænd / sluk
8	Demo funktion	Aktiveringskode: 2468
9	Softwareversion	Kontroller
10	Nulstil alle indstillinger	Ja/nej

Fejlfinding

Hvis du støder på et problem med dit apparat, kan du se kapitlet "Fejlfinding" i den

fulde version af brugervejledningen, som findes på: www.ikea.com.

Produktoplysninger og produktinformationsark

Leverandørens navn	IKEA
Identifikation af model	FORNEBY 305.577.90 FORNEBY 605.568.88
Energieffektivitetsindeks	81.2

Energieffektivitetsklasse	A+	
Energiforbrug med en standardmængde, almindelig tilstand	0.93 kWh/cyklus	
Energiforbrug med en standardmængde, blæsertvungen tilstand	0.69 kWh/cyklus	
Antal ovnrør	1	
Varmekilde	Elektricitet	
Lydstyrke	72 l	
Type ovn	Indbygningsovn	
Vægt	FORNEBY 305.577.90	33.0 kg
	FORNEBY 605.568.88	33.0 kg
IEC/EN 60350-1 - Elektriske husholdningsapparater til madlavning - Del 1: Komfurer, ovne, dampovne og grillapparater - Metoder til måling af ydeevne.		

Beschrijving van het product

Algemeen overzicht

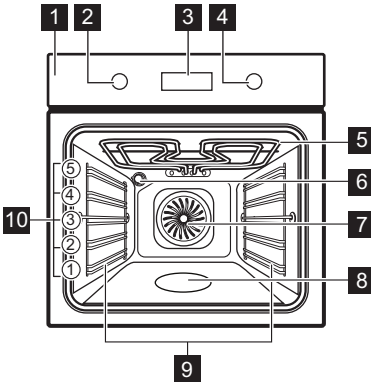

- 1 Bedieningspaneel
- 2 Knop voor verwarmingsfuncties
- 3 Display
- 4 Bedieningsknop
- 5 Verwarmingselement
- 6 Lamp
- 7 Ventilator
- 8 Uitsparing in de ovenruimte
- 9 Inschuifrails, verwijderbaar
- 10 Inzetniveaus

Bedieningspaneel

Overzicht bedieningspaneel

Selecteer een verwarmingsfunctie om het apparaat in te schakelen. Draai de knop voor de verwarmingsfuncties naar de uit-stand om het apparaat uit te schakelen.

	Druk om het volgende in te stellen: Klok-functies.
	Houd ingedrukt om de functie in te stellen: Snel opwarmen.
	Druk op om de ovenlamp in of uit te schakelen.
	Houd ingedrukt om de functie in te stellen: Blokkering.
OK	Druk op om de selectie te bevestigen.

	Het apparaat is vergrendeld.
	Open het menu en selecteer het pictogram dat u wilt openen: Kook- En Bakassistent.
	Open het menu en selecteer het pictogram dat u wilt openen: Instellingen
	Snel opwarmen wordt ingeschakeld.
	Stoomkoken is ingeschakeld.
	Kookwekker wordt ingeschakeld.
	Eindtijd wordt ingeschakeld.
	Uitsteltijd wordt ingeschakeld.
	Uptimer wordt ingeschakeld.
	De balk is volledig rood wanneer de oven de ingestelde temperatuur bereikt.

Indicatielampjes op de display

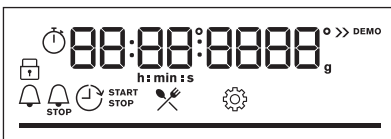

Display met toetsfuncties.

Dagelijks gebruik

Verwarmingsfuncties

	Hetelucht: Zelfs bakken, malsheid, drogen
	Boven + onderwarmte: Traditioneel bakken
	SteamBake: Stomen
	Bevroren gerechten: Patat, aardappelpartjes, lentebroodjes
	Pizza-functie: Pizza bakken
	Onderwarmte: Baktaarten
	Warmelucht (vochtig): Bakken
	Grillen: Roosteren, grillen
	Circulatiegrill: Braadvlees, bruining
	Menu: Om het menu te openen.

Hetelucht, Boven + onderwarmte: Als u de temperatuur instelt onder 80°C, gaat de lamp na 30 seconden automatisch uit.

Notities over: Warmelucht (vochtig)

Deze functie wordt gebruikt om te voldoen aan de energie-efficiëntieklasse en ecodesign-vereisten (overeenkomstig EU 65/2014 en EU 66/2014). Testen in overeenstemming met:

IEC/EN 60350-1

De ovendeur dient tijdens de bereiding gesloten te zijn zodat de functie niet wordt onderbroken en de oven werkt op de hoogst mogelijke energie-efficiëntie.

Bij gebruik van deze functie gaat de verlichting na 30 seconden automatisch uit.

Deze functie is ontworpen om tijdens de bereiding energie te besparen. Bij het gebruik van deze functie kan de temperatuur in de ruimte verschillen van de ingestelde temperatuur. Het verwarmingsvermogen kan worden vermindert.

Kook- En Bakassistent

Het display toont **P** en een **nummer** van het gerecht dat u in de tabel kunt controleren.

1	Biefstuk, rauw
2	Biefstuk: medium
3	Biefstuk, gaar
4	Biefstuk, medium
5	Rundvlees geroosterd / gestoofd
6	Biefstuk, rauw LTC*
7	Biefstuk, medium LTC*
8	Biefstuk, gaar LTC*
9	Filet, zeldzame LTC*
10	Filet, medium LTC*
11	Filet, uitgevoerd LTC*
12	Kalfsgebraad
13	Geroosterde varkenshals of schouder
14	Aangetrokken varkensvlees LTC*
15	Lende, vers
16	Spare ribs
17	Lambeen met botten
18	Hele kip
19	Halve kip
20	Kippenborst
21	Kippenpoten, vers
22	Hele eend
23	Gans, heel
24	Vleesbrood
25	Hele vis, gegrild

26	Visfilet
27	Cheesecake
28	Appelcake
29	Appeltaart
30	Appeltaart
31	Brownies
32	Chocolade muffins
33	Broodcake
34	Gebakken aardappelen
35	Aardappelpartjes
36	Gegrilde gemengde groenten
37	Kroketten, bevroren
38	Patat, bevroren
39	Vlees-/groentelasagne met droge noedelplaten
40	Aardappelgratin
41	Verse pizza, dun
42	Verse pizza, dik
43	Quiche
44	Baguette / ciabatta / witbrood
45	Volledig graan / rogge / bruin brood volledig graan in broodpan

*LTC - Koken op lage temperatuur

Probleemoplossing

Als u op een probleem met uw apparaat stuit, raadpleeg dan het hoofdstuk "Probleemoplossing" in de volledige versie

Instellingen wijzigen

- ☰ - selecteer om in te voerenMenu.
- ⚙️ - selecteer om in te voerenInstellingen. Druk op **OK**.
- Draai aan de knop om de instelling te selecteren. Druk op **OK**.
- Pas de waarde aan. Druk op **OK**. Draai de knop voor de verwarmingsfuncties naar de uit-stand om Menu af te sluiten.

Menu: Instellingen

Het display toont **0** en een **nummer** van de instelling die u in de tabel kunt controleren.

	Instellingen	Waarde
1	Dagtijd	Wijzigen
2	Helderheid display	1 - 5
3	Toetstonen	1 - Piep, 2 - Klik, 3 - Geluid uit
4	Geluidsvolume	1 - 4
5	Uptimer	Aan/uit
6	Binnenverlichting	Aan/uit
7	Snel opwarmen	Aan/uit
8	Demofunctie	Activeringscode: 2468
9	Softwareversie	Controleren
10	Terug naar fabrieksinstellingen	Ja / Nee

van de gebruikershandleiding, beschikbaar op: www.ikea.com.

Productinformatie en productinformatieblad

Naam leverancier	IKEA
Modelnummer	FORNEBY 305.577.90 FORNEBY 605.568.88

Om de volledige versie te downloaden, gaat u naar www.ikea.com

Energie-efficiëntie-index	81.2	
Energie-efficiëntieklasse	A+	
Energieverbruik met een standaard belading, conventionele modus	0.93 kWh/cyclus	
Energieverbruik met een standaard belasting, heteluchtmodus	0.69 kWh/cyclus	
Aantal holtes	1	
Warmtebron	Elektriciteit	
Volume	72 l	
Soort oven	Inbouwoven	
Massa	FORNEBY 305.577.90	33.0 kg
	FORNEBY 605.568.88	33.0 kg
IEC/EN 60350-1 - Huishoudelijke elektrische kooktoestellen - Deel 1: Fornoizen, ovens, stoomovens en grills - Methoden voor het meten van prestaties.		

Product description

General overview

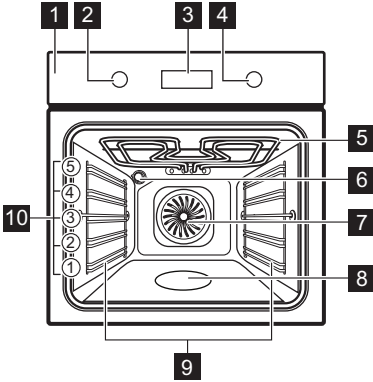

- 1 Control panel
- 2 Knob for the heating functions
- 3 Display
- 4 Control knob
- 5 Heating element
- 6 Lamp
- 7 Fan
- 8 Cavity embossment
- 9 Shelf support, removable
- 10 Shelf positions

Control panel

Control panel overview

Select a heating function to turn on the appliance. Turn the knob for the heating functions to the off position to turn the appliance off.

	Press to set: Clock functions.
	Press and hold to set the function: Fast Heat Up.
	Press to turn on or to turn off the oven lamp.
	Press and hold to set the function: Lock.
OK	Press to confirm the selection.

Display indicators

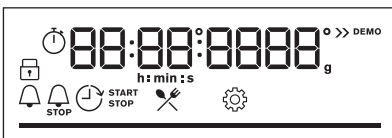











Display with key functions.

	The appliance is locked.
	Enter the menu and select the icon to open: Assisted Cooking.
	Enter the menu and select the icon to open: Settings
	Fast Heat Up is turned on.
	Steam cooking is turned on.
	Minute minder is turned on.
	End time is turned on.
	Time Delay is turned on.
	Uptimer is turned on.
	The bar is fully red when the appliance reaches the set temperature.

Daily use

Heating functions

	True Fan Cooking: Even baking, tenderness, drying
	Conventional Cooking: Traditional baking
	SteamBake: Steaming
	Frozen Foods: French fries, potato wedges, spring rolls
	Pizza Function: Baking pizza
	Bottom Heat: Baking cakes
	Moist Fan Baking: Baking
	Grill: Toasting, grilling
	Turbo Grilling: Roasting meat, browning
	Menu: To enter the menu.

True Fan Cooking, Conventional Cooking:
When you set the temperature below 80 °C the lamp automatically turns off after 30 sec.

Notes on: Moist Fan Baking

This function was used to comply with the energy efficiency class and ecodesign requirements (according to EU 65/2014 and EU 66/2014). Tests according to:

IEC/EN 60350-1

The oven door should be closed during cooking so that the function is not interrupted and the oven operates with the highest energy efficiency possible.

When you use this function the lamp automatically turns off after 30 sec.

This function is designed to save energy during cooking. When you use this function, the temperature in the cavity may differ from the set temperature. The heating power may be reduced.

Assisted Cooking

The display shows **P** and a **number** of the dish that you can check in the table.

1	Roast Beef, rare
2	Roast Beef, medium
3	Roast Beef, well done
4	Steak, medium
5	Beef roast / braised
6	Roast Beef, rare LTC*
7	Roast Beef, medium LTC*
8	Roast Beef, well done LTC*
9	Fillet, rare LTC*
10	Fillet, medium LTC*
11	Fillet, done LTC*
12	Veal roast
13	Pork roast neck or shoulder
14	Pulled pork LTC*
15	Loin, fresh
16	Spare Ribs
17	Lamb leg with bones
18	Whole chicken
19	Half chicken
20	Chicken breast
21	Chicken legs, fresh
22	Duck, whole
23	Goose, whole
24	Meat loaf
25	Whole fish, grilled
26	Fish fillet
27	Cheesecake
28	Apple cake

29	Apple tart
30	Apple pie
31	Brownies
32	Chocolate muffins
33	Loaf cake
34	Baked potatoes
35	Wedges
36	Grilled mixed vegetables
37	Croquets, frozen
38	Pommes, frozen
39	Meat / vegetable lasagna with dry noodle plates
40	Potato gratin
41	Pizza fresh, thin
42	Pizza fresh, thick
43	Quiche
44	Baguette / Ciabatta / White bread
45	All grain / rye / dark bread all grain in loaf pan

*LTC - Low Temperature Cooking

Changing settings

- ☰ - select to enter Menu.

Troubleshooting

If you encounter an issue with your appliance, check "Troubleshooting" chapter

- ⚙️ - select to enter Settings. Press OK.
 - Turn the knob to select the setting. Press OK.
 - Adjust the value. Press OK.
- Turn the knob for the heating functions to the off position to exit the Menu.

Menu: Settings

The display shows **0** and a **number** of the setting that you can check in the table.

	Setting	Value
1	Time of day	Change
2	Display brightness	1 - 5
3	Key tones	1 - Beep, 2 - Click, 3 - Sound off
4	Buzzer volume	1 - 4
5	Uptimer	On / Off
6	Light	On / Off
7	Fast Heat Up	On / Off
8	Demo mode	Activation code: 2468
9	Software version	Check
10	Reset all settings	Yes / No

in the full version of the User Manual available on: www.ikea.com.

Product Information and Product Information Sheet

Supplier's name	IKEA
Model identification	FORNEBY 305.577.90 FORNEBY 605.568.88
Energy Efficiency Index	81.2
Energy efficiency class	A+

Energy consumption with a standard load, conventional mode	0.93 kWh/cycle	
Energy consumption with a standard load, fan-forced mode	0.69 kWh/cycle	
Number of cavities	1	
Heat source	Electricity	
Volume	72 l	
Type of oven	Built-In Oven	
Mass	FORNEBY 305.577.90	33.0 kg
	FORNEBY 605.568.88	33.0 kg
IEC/EN 60350-1- Household electric cooking appliances - Part 1: Ranges, ovens, steam ovens and grills - Methods for measuring performance.		

Description de l'appareil

Vue d'ensemble

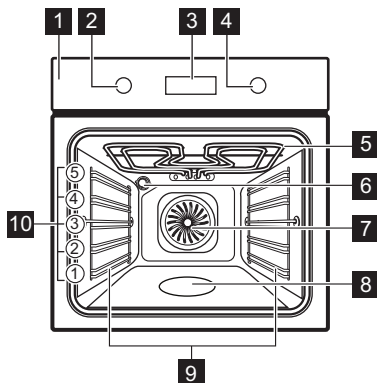

- 1 Bandeau de commande
- 2 Manette de sélection des modes de cuisson
- 3 Affichage
- 4 Manette de commande
- 5 Résistance
- 6 Éclairage
- 7 Chaleur tournante
- 8 Bac de la cavité
- 9 Support de grille, amovible
- 10 Niveaux de la grille

Bandeau de commande

Vue d'ensemble du bandeau de commande

Sélectionnez un mode de cuisson pour mettre en fonctionnement l'appareil. Tournez la manette des modes de cuisson sur la position Arrêt pour éteindre l'appareil.

	Appuyez pour régler sur : Fonctions de l'horloge.
	Maintenez la touche appuyée pour régler la fonction : Préchauffage rapide.
	Appuyez pour mettre en fonctionnement et à l'arrêt l'éclairage du four.
	Maintenez la touche appuyée pour régler la fonction : Touches Verrouil.
OK	Appuyez pour confirmer la sélection.

Voyants de l'affichage

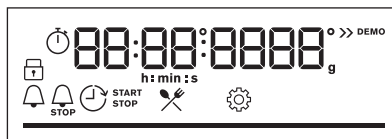









Affichage avec les principales fonctions.

	L'appareil est verrouillé.
	Accédez au menu et sélectionnez l'icône pour ouvrir : Cuisson assistée.
	Accédez au menu et sélectionnez l'icône pour ouvrir : Configurations
	Préchauffage rapide est allumé.
	La cuisson vapeur est activée.
	Minuteur est allumé.
	Fin de cuisson est allumé.
	Départ différé est allumé.
	Compteur est allumé.

	La barre est entièrement rouge lorsque l'appareil atteint la température réglée.
--	--

Utilisation quotidienne

Modes de cuisson

	Chaleur tournante: Cuisson homogène, tendreté, séchage
	Chauffage Haut/Bas: Cuisson traditionnelle
	SteamBake: Cuisson vapeur
	Plats Surgelés: Frites, pommes quartiers, rouleaux de printemps
	Fonction Pizza: Cuisson de pizza
	Chauffage inférieur: Cuisson de gâteaux
	Chaleur Tournante Humide: Cuisson
	Gril: Toaster, griller
	Turbo gril: Rôtir la viande, faire dorer
	Menu : Pour accéder au menu.

Chaleur tournante, Chauffage Haut/Bas : Lorsque vous réglez la température en dessous de 80 °C, l'éclairage s'éteint automatiquement au bout de 30 secondes.

Remarques sur : Chaleur Tournante Humide

Cette fonction était utilisée pour se conformer à la classe d'efficacité énergétique et aux exigences Ecodesign (selon les normes EU 65/2014 et EU 66/2014). Tests conformes aux normes :

IEC/EN 60350-1

La porte du four doit être fermée pendant la cuisson pour que la fonction ne soit pas interrompue et que le four fonctionne avec la plus grande efficacité énergétique possible.

Lorsque vous utilisez cette fonction, l'éclairage s'éteint automatiquement au bout de 30 secondes.

Cette fonction est conçue pour économiser de l'énergie en cours de cuisson. Lorsque vous utilisez cette fonction, la température à l'intérieur de la cavité peut différer de la température sélectionnée. La puissance peut être réduite.

Cuisson assistée

L'affichage indique **P** et un **certain nombre** de plats que vous pouvez vérifier dans le tableau.

1	Rôti de bœuf, saignant
2	Rôti de bœuf, à point
3	Rôti de bœuf, bien cuit
4	Steak de bœuf, à point
5	Rôti de bœuf/braisé
6	Rôti de bœuf, CBT* saignant
7	Rôti de bœuf, CBT* à point
8	Rôti de bœuf, CBT* bien cuit
9	Filet, CBT* saignant
10	Filet, CBT* à point
11	Filet, CBT* bien cuit
12	Rôti de veau
13	Rôti de porc - collet ou épaule
14	Émincé de porc CBT*
15	Longe, fraîche
16	Travers
17	Gigot d'agneau avec os
18	Poulet entier

19	Demi poulet
20	Escalope de poulet
21	Cuisses de poulet, fraîches
22	Canard entier
23	Oie entière
24	Rôti haché
25	Poisson entier, grillé
26	Filet de poisson
27	Gâteau au fromage
28	Gâteau aux pommes
29	Tarte aux pommes
30	Tarte aux pommes
31	Brownies
32	Muffins au chocolat
33	Quatre-quarts
34	Pommes de terre au four
35	Pommes quartiers
36	Mélange de légumes grillés
37	Croquettes surgelées
38	Pommes, surgelées
39	Lasagnes de viande / légumes avec assiettes de nouilles sèches
40	Gratin de pommes de terre
41	Pizza fraîche, fine
42	Pizza fraîche, épaisse
43	Quiche

44	Baguette/Ciabatta/Pain blanc
45	Tous grains/seigle/pain complet grains entiers dans un moule à pain

*CBT -Cuisson à basse température

Modification des réglages

- ☰ - sélectionnez pour accéder au Menu .
- ⚙️ - sélectionnez pour accéder au Configurations. Appuyez sur OK.
- Tournez la manette pour sélectionner le réglage. Appuyez sur la touche OK.
- Réglez la valeur. Appuyez sur la touche OK.

Tournez la manette des modes de cuisson sur la position Arrêt pour quitter le Menu .

Menu : Configurations

L'affichage indique **0** et un **certain nombre** de réglages que vous pouvez vérifier dans le tableau.

	Réglage	Valeur
1	Heure actuelle	Modifier
2	Affichage Luminosité	1 - 5
3	Son touches	1 - Bip, 2 - Clic, 3 - Son désactivé
4	Volume alarme	1 - 4
5	Compteur	Marche / Arrêt
6	Eclairage four	Marche / Arrêt
7	Préchauffage rapide	Marche / Arrêt
8	Mode démo	Code d'activation : 2468
9	Version du logiciel	Contrôle
10	Réinitialiser tous les réglages	Oui/Non

Dépannage

Si vous rencontrez un problème avec votre appareil, consultez le chapitre « Dépannage » dans la version complète du

Manuel de l'utilisateur disponible sur : www.ikea.com.

Informations produit et fiche d'informations produit

Nom du fournisseur	IKEA	
Identification du modèle	FORNEBY 305.577.90 FORNEBY 605.568.88	
Indice d'efficacité énergétique	81.2	
Classe d'efficacité énergétique	A+	
Consommation d'énergie avec charge standard, en mode conventionnel	0.93 kWh/cycle	
Consommation d'énergie avec charge standard, en mode chaleur tournante	0.69 kWh/cycle	
Nombre de cavités	1	
Source de chaleur	Électricité	
Volume	72 l	
Type de four	Four encastrable	
Masse	FORNEBY 305.577.90	33.0 kg
	FORNEBY 605.568.88	33.0 kg
IEC/EN 60350-1 - Appareils de cuisson domestiques électriques - Partie 1 : Cuisinières, fours, fours à vapeur et grils : Méthodes de mesure des performances.		

Gerätebeschreibung

Gesamtansicht

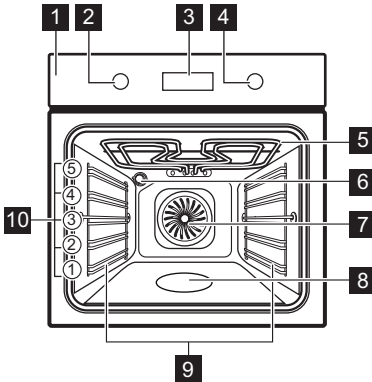

- 1 Bedienfeld
- 2 Einstellknopf für die Ofenfunktionen
- 3 Display
- 4 Einstellknopf
- 5 Heizelement
- 6 Lampe
- 7 Ventilator
- 8 Garraumvertiefung
- 9 Einschubschienen, herausnehmbar
- 10 Einschubebenen

Bedienfeld

Überblick - Bedienfeld

Wählen Sie eine Ofenfunktion, um das Gerät einzuschalten. Drehen Sie den Knopf für die Ofenfunktionen in die Aus-Position, um das Gerät auszuschalten.

	Zum Einstellen drücken: Uhrfunktionen.
	Halten Sie die Taste gedrückt, um die Funktion einzustellen: Schnellaufheizung
	Zum Ein- und Ausschalten der Backofenlampe drücken.
	Halten Sie die Taste gedrückt, um die Funktion einzustellen: Verriegelung
OK	Zur Bestätigung der Auswahl drücken.

	Das Gerät ist verriegelt.
	Öffnen Sie das Menü und wählen Sie das zu öffnende Symbol aus: Koch-Assistent.
	Öffnen Sie das Menü und wählen Sie das zu öffnende Symbol aus: Einstellungen
	Schnellaufheizung ist eingeschaltet.
	Dampfgaren ist eingeschaltet.
	Kurzzeit-Wecker ist eingeschaltet.
	Ende ist eingeschaltet.
	Zeitvorwahl ist eingeschaltet.
	Uptimer ist eingeschaltet.
	Der Balken ist vollständig rot, wenn das Gerät die eingestellte Temperatur erreicht.

Display-Anzeigen

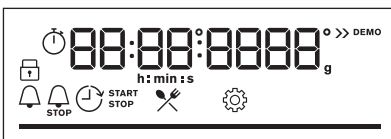

Display mit Tastenfunktionen.

Täglicher Gebrauch

Ofenfunktionen

	Heißluft: Gleichmäßiges Backen, Zartheit, Dörren
	Ober-/Unterhitze: Traditionelles Backen
	SteamBake: Dampfgaren
	Tiefkühlgerichte: Pommes frites, Kartoffel- spalten, Frühlingsrollen
	Pizzastufe: Backen von Pizza
	Unterhitze: Kuchen backen
	Feuchte Umluft: Backen
	Grill: Toasten, Grillen
	Heißluftgrillen: Braten von Fleisch, Bräunen
	Menü: Aufrufen des Menüs.

Heißluft, Ober-/Unterhitze: Wenn Sie die Temperatur auf unter 80 °C einstellen, schaltet sich die Lampe nach 30 Sekunden automatisch aus.

Hinweise zu: Feuchte Umluft

Diese Funktion wurde zur Einhaltung der Energieeffizienzklasse und der Ökodesign-Anforderungen (gemäß EU 65/2014 und EU 66/2014) verwendet. Tests gemäß:

IEC/EN 60350-1

Die Backofentür sollte während des Garvorgangs geschlossen bleiben, damit die Funktion nicht unterbrochen wird. So wird gewährleistet, dass der Backofen mit der höchsten Energieeffizienz arbeitet.

Wenn Sie diese Funktion verwenden, schaltet sich die Backofenbeleuchtung automatisch nach 30 Sekunden aus.

Diese Funktion ist entwickelt worden, um während des Kochvorgangs Energie zu sparen. Wenn Sie diese Funktion nutzen, kann die Temperatur im Garraum von der eingestellten Temperatur abweichen. Die Wärmeleistung kann geringer sein.

Koch-Assistent

Das Display zeigt **P** und eine **Anzahl** der Gerichte an, die Sie in der Tabelle überprüfen können.

1	Roastbeef, blutig
2	Roastbeef, rosa
3	Roastbeef, durch
4	Steak, rosa
5	Rinderbraten / geschmort
6	Roastbeef, blutig LTC*
7	Roastbeef, rosa LTC*
8	Roastbeef, durch LTC*
9	Filet, blutig LTC*
10	Filet, rosa LTC*
11	Filet, fertig LTC*
12	Kalbsbraten
13	Schweinebraten oder Schulter
14	Pulled Pork LTC*
15	Lende, frisch
16	Rippchen
17	Lammkeule mit Knochen
18	Hähnchen, ganz
19	Halbes Hähnchen
20	Hähnchenbrust
21	Hähnchenschenkel, frisch
22	Ente, ganz
23	Gans, ganz
24	Hackbraten
25	Fisch, gegrillt

26	Fischfilet
27	Käsekuchen
28	Apfelkuchen
29	Apfelkuchen
30	Apfelkuchen
31	Brownies
32	Schokoladenmuffins
33	Brotkuchen
34	Ofenkartoffeln
35	Kartoffelspalten
36	Gegrilltes Gemüse
37	Kroketten, gefroren
38	Pommes frites, gefroren
39	Fleisch- / Gemüselasagne mit trockenen Nudelplatten
40	Kartoffelgratin
41	Pizza frisch, dünn
42	Pizza frisch, dick
43	Quiche
44	Baguette / Ciabatta / Weißbrot
45	Alle Getreide / Roggen / dunkles Brot, alle Getreide in Kastenform

*LTC - Niedertemperaturgaren

Einstellungen ändern

- ☰ – wählen, um Menü einzugeben.

Problembekämpfung

Wenn Sie ein Problem mit Ihrem Gerät haben, lesen Sie das Kapitel „Fehlerbehebung“ in der Vollversion des

- ⚙️ – wählen, um Einstellungen einzugeben. Drücken Sie **OK**.
- Drehen Sie den Knopf, um die Einstellung auszuwählen. Drücken Sie **OK**.
- Passen Sie den Wert an. Drücken Sie **OK**. Drehen Sie den Knopf für die Ofenfunktionen in die Aus-Position, um Menü zu verlassen.

Menü: Einstellungen

Das Display zeigt **0** und eine **Anzahl** der Einstellungen an, die Sie in der Tabelle überprüfen können.

	Einstellung	Wert
1	Uhrzeit	Ändern
2	Helligkeit	1 - 5
3	Tastentöne	1 - Piepton, 2 - Klicks, 3 - Ton aus
4	Lautstärke	1 - 4
5	Uptimer	Ein / Aus
6	Backofenbeleuchtung	Ein / Aus
7	Schnellaufheizung	Ein / Aus
8	DEMO	Aktivierungscode: 2468
9	Softwareversion	Prüfen
10	Gerät auf Werkseinstellungen zurücksetzen	Ja / Nein

Benutzerhandbuchs, das auf folgenden Seiten verfügbar ist: www.ikea.com.

Produktinformationen und Produktinformationsblatt

Name des Lieferanten	IKEA	
Modellbezeichnung	FORNEBY 305.577.90 FORNEBY 605.568.88	
Energieeffizienzindex	81.2	
Energieeffizienzklasse	A+	
Energieverbrauch mit einer Standardbeladung, konventioneller Modus	0.93 kWh/Programm	
Energieverbrauch mit einer Standardbeladung, Umluft-Modus	0.69 kWh/Programm	
Anzahl der Garräume	1	
Wärmequelle	Strom	
Volumen	72 l	
Art des Backofens	Eingebauter Backofen	
Masse	FORNEBY 305.577.90	33.0 kg
	FORNEBY 605.568.88	33.0 kg
IEC/EN 60350-1 – Elektrische Kochgeräte für den Hausgebrauch – Teil 1: Stufen, Backöfen, Dampfüfen und Grills – Methoden zur Leistungsmessung.		

Descrizione del prodotto

Panoramica generale

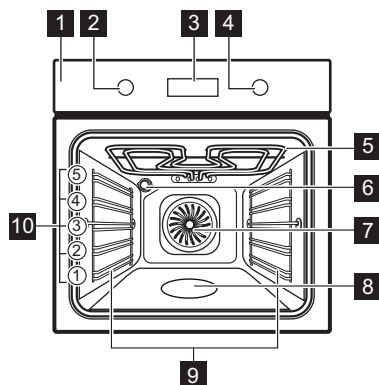

- 1 Pannello dei comandi
- 2 Manopola di regolazione delle funzioni cottura
- 3 Display
- 4 Manopola di regolazione
- 5 Resistenza
- 6 Lampadina
- 7 Ventola
- 8 Goffratura cavità
- 9 Supporto ripiano, rimovibile
- 10 Posizioni ripiano

Pannello dei comandi

Panoramica del pannello di controllo

Selezionare una funzione cottura per accendere l'elettrodomestico. Per spegnere l'elettrodomestico, ruotare la manopola delle funzioni cottura fino a portarla in posizione off.

	Premere per impostare: Funzioni Orologio.
	Tenere premuto per impostare la funzione: Riscaldamento rapido.
	Premere per accendere o spegnere la lampadina del forno.
	Tenere premuto per impostare la funzione: Blocco.
OK	Premere per confermare la selezione.

Spie display

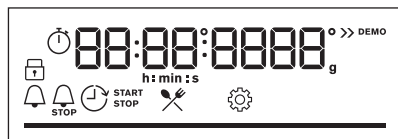

Display con le funzioni chiave.

	L'apparecchiatura è bloccata.
	Accedere al menu e selezionare l'icona da aprire: Cottura guidata.
	Accedere al menu e selezionare l'icona da aprire: Impostazioni
	Riscaldamento rapido è acceso.
	La cottura a vapore è attivata.
	Contaminuti è acceso.
	Orario fine è acceso.
	Ritardo è acceso.
	Timer è acceso.
	Quando l'elettrodomestico raggiunge la temperatura impostata, la barra è completamente rossa.

Utilizzo quotidiano

Funzioni cottura

	Cottura ventilata: Cottura omogenea, tenerezza, essiccazione
	Cottura convenzionale: Cottura tradizionale
	SteamBake: Cottura a vapore
	Cibi congelati: Patatine fritte, spicchi di patate, involtini primavera
	Funzione Pizza: Preparazione della pizza
	Resistenza inferiore: Preparazione di dolci da forno
	Cottura ventilata umida: Cottura al forno
	Grill: Tostatura, cottura al grill
	Doppio grill ventilato: Arrostire carne, rosolare
	Menu: Per accedere al menu.

Cottura ventilata, Cottura convenzionale: Quando si imposta la temperatura al di sotto di 80 °C, la lampada si spegne automaticamente dopo 30 secondi.

Note su: Cottura ventilata umida

Questa funzione è stata utilizzata per la conformità alla classe energetica e ai requisiti di ecodesign (secondo la normativa EU 65/2014 e EU 66/2014). Test conformemente a:

IEC/EN 60350-1

La porta del forno dovrebbe essere chiusa in fase di cottura, in modo che la funzione non venga interrotta. Ciò garantisce inoltre che il forno funzioni con la più elevata efficienza energetica possibile.

Quando viene usata questa funzione, la lampada si spegne automaticamente dopo 30 secondi.

Questa funzione è progettata per il risparmio energetico durante la cottura. Quando si utilizza questa funzione, la temperatura all'interno della cavità potrebbe essere diversa rispetto alla temperatura

impostata. La potenza riscaldante potrebbe essere ridotta.

Cottura guidata

Sul display viene visualizzato **P** e il **numero** del piatto, che è possibile controllare nella tabella.

1	Roast beef, al sangue
2	Roast beef, cottura media
3	Roast beef, ben cotto
4	Bistecca, media cottura
5	Manzo arrosto / brasato
6	Roast beef, LTC al sangue*
7	Arrosto di manzo, LTC cottura media*
8	Arrosto di manzo, LTC ben cotto*
9	Filetto, LTC al sangue*
10	Filetto, LTC medio*
11	Filetto, LTC cotto*
12	Arrosto di vitello
13	Collo o spalla di maiale arrosto
14	Maiale sfilacciato LTC*
15	Lombo, fresco
16	Costolette di maiale
17	Cosciotto d'agnello con ossa
18	Pollo intero
19	Mezzo pollo
20	Pollo, petto
21	Cosce di pollo, fresche
22	Anatra, intera
23	Oca, intera

24	Polpettone
25	Pesce intero, grigliato
26	Filetto di pesce
27	Torta ai formaggi
28	Torta di mele
29	Crostata di mele
30	Torta di mele americana
31	Brownies
32	Muffin al cioccolato
33	Torta di pane
34	Patate al forno
35	Spicchi
36	Verdure miste grigliate
37	Crocchette, surgelate
38	Patatine, surgelate
39	Lasagne di carne/verdure con piatti di pasta-sciutta
40	Patate gratinate
41	Pizza fresca, sottile
42	Pizza fresca, spessa
43	Quiche
44	Baguette / Ciabatta / Pane bianco

45	Impasto per pane integrale / pane di segale / pane nero in uno stampo per pane
----	--

*LTC - Cottura a bassa temperatura

Modifica delle impostazioni

- ☰ - selezionare per immettere Menu.
- ⚙️ - selezionare per immettere Impostazioni. Premere **OK**.
- Ruotare la manopola per selezionare l'impostazione. Premere **OK**.
- Regolare il valore. Premere **OK**. Ruotare la manopola per le funzioni cottura sulla posizione off per uscire da Menu.

Menu: Impostazioni

Il display mostra **0** e una **serie** di impostazioni che è possibile controllare nella tabella.

	Impostazione	Valore
1	Imposta ora	Modifica
2	Luminosità	1 - 5
3	Volume toni	1 - Bip, 2 - Clic, 3 - Suono disattivato
4	Volume acustico	1 - 4
5	Timer	On/Off
6	Luce forno	On/Off
7	Riscaldamento rapido	On/Off
8	Modalità demo	Codice di attivazione: 2468
9	Versione software	Controllare
10	Ripristino impostazioni iniziali di fabbrica	Si / No

Risoluzione dei problemi

In caso di problemi con l'apparecchiatura consultare il capitolo "Risoluzione dei problemi" nella versione completa del

Manuale d'uso disponibile su:
www.ikea.com.

Informazioni sul prodotto e scheda informativa del prodotto

Nome del fornitore	IKEA	
Identificazione modello	FORNEBY 305.577.90 FORNEBY 605.568.88	
Indice di efficienza energetica	81.2	
Classe di efficienza energetica	A+	
Consumo energetico con carico standard, modalità tradizionale	0.93 kWh/ciclo	
Consumo di energia con un carico standard, modalità a circolazione d'aria forzata	0.69 kWh/ciclo	
Numero di cavità	1	
Fonte di calore	Elettricità	
Volume	72 l	
Tipo di forno	Forno da incasso	
Massa	FORNEBY 305.577.90	33.0 kg
	FORNEBY 605.568.88	33.0 kg
IEC/EN 60350-1- Apparecchiature elettriche per la cottura per uso domestico - Parte 1: Cucine, forni, forni a vapore e griglie - Metodi per la misura delle prestazioni.		

Produktbeskrivelse

Generell oversikt

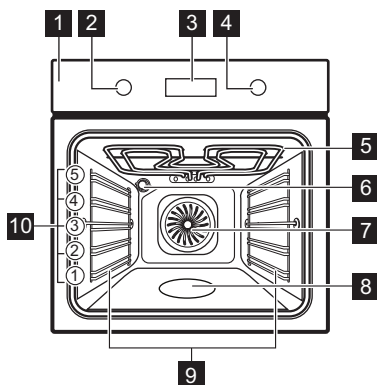

- 1 Betjeningspanel
- 2 Bryter for ovnsfunksjoner
- 3 Display
- 4 Betjeningsbryter
- 5 Varmeelement
- 6 Lys
- 7 Vifte
- 8 Nedsenkning i ovnsrom
- 9 Uttakbare brettstiger
- 10 Hyllnivåer

Betjeningspanel

Oversikt over betjeningspanel

Velg en ovnsfunksjon for å slå på produktet. Vri bryteren for ovnsfunksjoner til avposisjonen for å slå av ovnen.

	Trykk for å stille inn: Klokkefunksjonene.
	Trykk og hold inne for å velge funksjonen: Hurtigoppvarming.
	Trykk for å slå på eller for å slå av ovnslampen.
	Trykk og hold inne for å velge funksjonen: Lås.
OK	Trykk på for å bekrefte valget.

Displayindikatorer

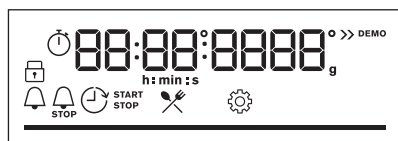

Display med nøkkelfunksjoner.

	Produktet er låst.
	Gå inn i menyen og velg ikonet for å åpne: Assistert matlaging.
	Gå inn i menyen og velg ikonet for å åpne: Innstillinger
	Hurtigoppvarming er slått på.
	Dampkoking er slått på.
	Varselur er slått på.
	Sluttid er slått på.
	Utsatt tid er slått på.
	Tidsinnstilling er slått på.
	Linjen er helt rød når ovnen når den innstilte temperaturen.

Daglig bruk

Varmefunksjoner

	Ekte Varmluft: Tilberedning, mørhet, tørking
	Over- og undervarme: Tradisjonell steking
	SteamBake: Damping
	Frossen mat: Pommes frites, potetbåter, vårruller
	Pizzafunksjon: Lage pizza
	Undervarme: Steking av kaker
	Baking med fukt: Steking
	Grill: Brødristing, grilling
	Gratinerer med vifte: Steke kjøtt, bruning
	Meny: For å gå inn i menyen.

Ekte Varmluft, Over- og undervarme: Når du stiller inn temperaturen under 80 °C, slås lampen automatisk av etter 30 sekunder.

Merknader om: Baking med fukt

Denne funksjonen blir brukt til å overholde energieffektivitetsklassen og økodesignkrav (i henhold til EU 65/2014 og EU 66/2014).
Tester i henhold til:

IEC/EN 60350-1

Stekeovnsdøren skal være lukket under tilberedning slik at funksjonen ikke forstyrres, og ovnen er i drift med høyest mulig energieffektivitet.

Når du bruker denne funksjonen, slås ovnslampen automatisk av etter 30 sekunder.

Denne funksjonen er laget med tanke på å spare energi når man lager mat. Når du bruker denne funksjonen, kan temperaturen i ovnsrommet variere fra den angitte temperaturen. Varmeeffekten kan reduseres.

Assistert matlaging

Displayet viser **P** og et **nummer** på retten som du kan kontrollere i tabellen.

1	Roastbiff, rå
2	Roastbiff, medium
3	Roastbiff, godt stekt
4	Biff, medium
5	Oksestek / brasert
6	Roastbiff, rå LTS*
7	Roastbiff, medium LTS*
8	Roastbiff, godt stekt LTS*
9	Filet, rå LTS*
10	Filet, medium LTS*
11	Filet, fullført LTS*
12	Stekt kalvekjøtt
13	Svinestek eller skulder
14	Pulled pork LTS*
15	Fersk filet
16	Spareribs
17	Lammelår med ben
18	Hel kylling
19	Halv kylling
20	Kyllingbryst
21	Kyllinglår, ferske
22	Hel and
23	Hel gås
24	Kjøttpudding
25	Hel fisk, grillet

26	Fiskefilét
27	Ostekake
28	Eplekake
29	Epleterte
30	Eplekake
31	Brownies
32	Sjokolademuffins
33	Brødkake
34	Bakte poteter
35	Kiler
36	Stekt blandede grønnsaker
37	Croquettes, frossen
38	Pommes frites, frossen
39	Kjøtt / grønnsaksolasagne med tørre nudeltallerkener
40	Potetgrateng
41	Fersk pizza, tynn
42	Pizza fersk, tykk
43	Quiche
44	Baguette / Ciabatta / loff
45	Kornet / rugbrød / mørkt brød i brødform

*LTS - Lavtemperatursteking

Feilsøking

Hvis du støter på et problem med produktet, sjekk kapittelet "Feilsøking" i den

Endre innstillinger

- ☰ - velg for å angi Meny.
- ⚙️ - velg for å angi Innstillinger. Trykk på OK.
- Drei bryteren for å velge innstilling. Trykk på OK.
- Juster verdien. Trykk på OK. Vri bryteren for ovnsfunksjoner til avposisjonen for å gå ut av Meny.

Meny: Innstillinger

Displayet viser **0** et et **antall** innstillinger som du kan kontrollere i tabellen.

	Innstilling	Verdi
1	Tid på dagen	Endre
2	Skjermlysstyrke	1 - 5
3	Tastelyder	1 - Pip, 2 - Klikk, 3 - Lyd av
4	Summerlyd	1 - 4
5	Tidsinnstilling	På/Av
6	Lys	På/Av
7	Hurtigoppvarming	På/Av
8	Demomodus	Aktiveringskode: 2468
9	Programvareversjon	Kontroller
10	Tilbakestill alle innstillinger	Ja / Nei

fullstendige versjonen av bruksanvisningen som er tilgjengelig på: www.ikea.com.

Produktinformasjon og produktinformasjonsark

Leverandørens navn	IKEA
Modellidentifikasjon	FORNEBY 305.577.90 FORNEBY 605.568.88
Energieffektivitetsindeks	81.2

For å laste ned fullversjonen, kan du besøke www.ikea.com

Energieffektivitetsklasse	A+	
Energiforbruk med standard matmengde, over- og undervarme	0.93 kWh/syklus	
Energiforbruk med standardbelastning, viftemodus	0.69 kWh/syklus	
Antall ovner	1	
Varmekilde	Elektrisitet	
Volum	72 l	
Ovnstyper	Innebygd ovn	
Masse	FORNEBY 305.577.90	33.0 kg
	FORNEBY 605.568.88	33.0 kg
IEC/EN 60350-1- Elektriske husholdningsapparater for matlaging - del 1: Sortiment, ovner, dampovner og griller - metoder for måling av ytelse.		

Descrição do produto

Visão geral

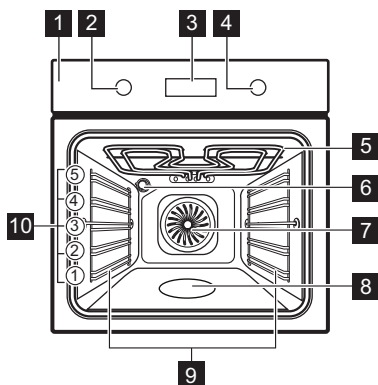

- 1 Painel de comandos
- 2 Botão para os tipos de aquecimento
- 3 Visor
- 4 Botão de controlo
- 5 Elemento de aquecimento
- 6 Lâmpada
- 7 Ventilador
- 8 Baixo relevo da cavidade
- 9 Apoio para prateleira, amovível
- 10 Nível das prateleiras

Painel de comandos

Descrição geral do painel de comandos

Selecione um tipo de aquecimento para ligar o aparelho. Rode o botão para os tipos de aquecimento para a posição off (desligado) para desligar o aparelho.

	Prima para definir: Funções do relógio.
	Prima sem soltar para selecionar a função: Aquecimento rápido.
	Prima para ligar ou desligar a lâmpada do forno.
	Prima sem soltar para selecionar a função: Bloquear.
OK	Prima para confirmar a seleção.

Indicadores do visor

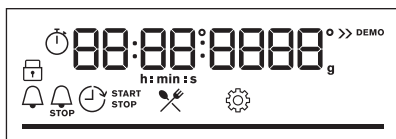









Visor com funções chave.

	O aparelho está bloqueado.
	Entre no menu e selecione o ícone para abrir: Cozedura assistida.
	Entre no menu e selecione o ícone para abrir: Definições
	A Aquecimento rápido está ativada.
	A cozedura a vapor está ligada.
	A Conta-minutos está ativada.
	A Hora de fim está ativada.
	A Atraso do temporizador está ativada.
	A Temporizador crescente está ativada.
	A barra fica totalmente vermelha quando o aparelho atinge a temperatura definida.

Utilização diária

Tipos de aquecimento

	Ventilado + Resistência Circ: Assado uniforme, tenro, seco
	Calor superior/inferior: Cozedura tradicional
	SteamBake: Vaporizar
	Congelados: Batatas fritas, batatas em fatias, rolos de primavera
	Função Pizza: Fazer pizza
	Aquecimento inferior: Cozer bolos
	Ventilado com Resistência: Cozer no forno
	Grelhador: Tostar, grelhar
	Grelhador ventilado: Assar carne, alourar
	Menu: Para entrar no menu.

Ventilado + Resistência Circ, Calor superior/inferior: Quando selecionar uma temperatura inferior a 80 °C, a lâmpada desliga-se automaticamente após 30 segundos.

Notas sobre: Ventilado com Resistência

Esta função foi utilizada para cumprir com os requisitos de classe eficiente energética e design ecológico (de acordo com as normas EU 65/2014 e EU 66/2014). Testes de acordo com:

IEC/EN 60350-1

A porta do forno deve estar fechada durante a cozedura para que a função não seja interrompida e o forno funcione com a mais alta eficiência energética possível.

Quando utiliza esta função, a lâmpada é automaticamente desativada após 30 seg.

Esta função foi concebida para poupar energia durante o cozinhado. Quando utilizar esta função, a temperatura na cavidade pode diferir a temperatura definida. A potência do aquecimento pode ser reduzida.

Cozedura assistida

O visor apresenta **P** e um **número** do prato que pode verificar na tabela.

1	Carne assada, mal passada
2	Carne assada, média
3	Carne assada, bem passada
4	Bife, médio
5	Carne assada/estufada
6	Carne assada, mal passada, LTC*
7	Carne assada, média, LTC*
8	Rosbife, bem passado, LTC*
9	Filete, mal passado, LTC*
10	Filete, médio, LTC*
11	Filete, bem passado, LTC*
12	Vitela assada
13	Cachaça ou pá de porco assada
14	Porco assado, LTC*
15	Lombo, fresco
16	Entrecosto
17	Perna de borrego com ossos
18	Frango inteiro
19	Meio frango
20	Peito de frango
21	Pernas de frango, frescas
22	Pato inteiro
23	Ganso, inteiro
24	Rolo de Carne
25	Peixe inteiro, grelhado

26	Filete de peixe
27	Cheesecake
28	Bolo de maçã
29	Tarte de maçã coberta
30	Tarte de maçã
31	Brownies
32	Queques de chocolate
33	Bolo em forma de pão
34	Batatas assadas
35	Fatias
36	Legumes misturados
37	Crequetes congelados
38	Batatas congeladas
39	Lasanha de carne/vegetais com pratos de massa seca
40	Batatas gratinadas
41	Pizza fresca, fina
42	Pizza fresca, grossa
43	Quiche
44	Baguete/Ciabatta/Pão branco
45	Pão integral/centeio/escuro integral em forma de pão

*LTC - Cozinhar a baixa temperatura

Resolução de problemas

Se tiver um problema com o seu aparelho, consulte o capítulo "Resolução de

Alterar definições

- ☰ - selecione para introduzir Menu.
- ⚙️ - selecione para introduzir Definições. Prima OK.
- Rode o botão para selecionar a definição. Premir OK.
- Ajuste o valor. Premir OK.
Rode o botão dos tipos de aquecimento para a posição de desligado para de Menu.

Menu: Definições

O visor apresenta 0 e um número da definição que pode verificar na tabela.

	Definição	Valor
1	Hora	Alterar
2	Brilho do visor	1 - 5
3	Sons "teclado"	1 - Bip, 2 - Clique, 3 - Som desligado
4	Volume do alarme	1 - 4
5	Temporizador crescente	Ligado/Desligado
6	Luz	Ligado/Desligado
7	Aquecimento rápido	Ligado/Desligado
8	Modo Demo	Código de ativação: 2468
9	Versão do software	Verificar
10	Restaurar configurações	Sim / Não

problemas" na versão completa do Manual do Utilizador disponível em: www.ikea.com.

Informação do produto e a Ficha de informação do produto

Nome do fornecedor	IKEA
Identificação do modelo	FORNEBY 305.577.90 FORNEBY 605.568.88

Índice de Eficiência Energética	81.2	
Classe de eficiência energética	A+	
Consumo de energia com uma carga normal, modo convencional	0.93 kWh/ciclo	
Consumo de energia com uma carga padrão, modo de ventilação forçada	0.69 kWh/ciclo	
Número de cavidades	1	
Fonte de calor	Eletricidade	
Volume	72 l	
Tipo de forno	Forno encastrado	
Massa	FORNEBY 305.577.90	33.0 kg
	FORNEBY 605.568.88	33.0 kg
IEC/EN 60350-1 - Aparelhos de cozinha elétricos domésticos - Parte 1: Fogões, fornos, fornos a vapor e grelhadores - Métodos para medir o desempenho.		

Descripción del producto

Resumen general

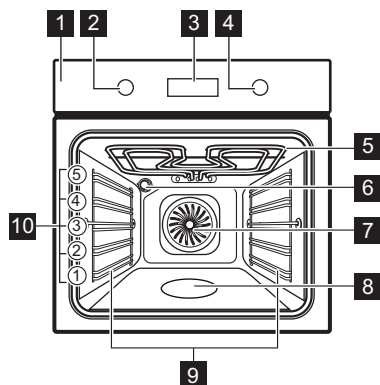

- 1 Panel de control
- 2 Mando de las funciones de cocción
- 3 Pantalla
- 4 Mando de control
- 5 Resistencia
- 6 Bombilla
- 7 Ventilador
- 8 Relieve de la cavidad
- 9 Soporte de parrilla extraíble
- 10 Posiciones de las parrillas

Panel de mandos

Vista general del panel de control

Seleccione una función de cocción para encender el aparato. Gire el mando de las funciones de cocción hasta la posición de apagado para apagar el aparato.

	Pulse para ajustar: Funciones de reloj.
	Mantenga pulsado para ajustar la función: Calentamiento rápido.
	Pulse para encender o apagar la lámpara del horno.
	Mantenga pulsado para ajustar la función: Bloqueo.
OK	Pulse para confirmar la selección.

Indicadores de pantalla

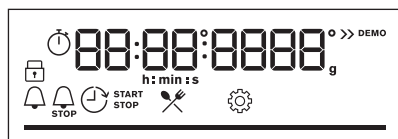











Pantalla con funciones principales.

	El aparato está bloqueado.
	Entre en el menú y seleccione el icono que desee abrir: Cocción asistida.
	Entre en el menú y seleccione el icono que desee abrir: Ajustes
	Calentamiento rápido está encendido.
	La cocción al vapor está activada.
	Avisador está encendido.
	Hora de fin está encendido.
	Tiempo de retardo está encendido.
	Tiempo de funcionamiento está encendido.
	La barra está completamente roja cuando el aparato alcanza la temperatura ajustada.

Uso diario

Funciones de cocción

	Aire caliente: Horneado uniforme, ternura, secado
	Cocción convencional: Horneado tradicional
	SteamBake: Cocción al vapor
	Congelados: Patatas fritas, patatas, rollitos de primavera
	Función Pizza: Hornear pizza
	Calor inferior: Hornear pasteles
	Horneado húmedo + ventilador: Horneado
	Grill: Tostar, asar a la parrilla
	Grill turbo: Asar carne, dorar
	Menú: Para acceder al menú.

Aire caliente, Cocción convencional: Cuando se ajusta la temperatura por debajo de 80 °C, la lámpara se apaga automáticamente después de 30 segundos.

Notas sobre: Horneado húmedo + ventilador

Esta función se utilizaba para cumplir con los requisitos de eficiencia energética y diseño ecológico (según EU 65/2014 y EU 66/2014). Pruebas según:

IEC/EN 60350-1

La puerta del horno debe estar cerrada durante la cocción para que no se interrumpa la función y el horno funcione con la máxima eficiencia energética posible.

Cuando se utiliza esta función, la lámpara se apaga automáticamente después de 30 s.

Función diseñada para ahorrar energía durante la cocción. Cuando se utiliza esta función, la temperatura del horno puede diferir de la temperatura programada. La potencia calorífica puede reducirse.

Cocción asistida



La pantalla muestra **P** y un **número** del plato que puede consultar en la tabla.

1	Rosbif, poco hecho
2	Rosbif, al punto
3	Rosbif, muy hecho
4	Bistec, en su punto
5	Asado de ternera/estofado
6	Rosbif, RTC poco hecho*
7	Rosbif, LTC en su punto*
8	Rosbif, muy hecho LTC*
9	Filete, poco hecho LTC*
10	Filete, LTC en su punto*
11	Filete, hecho LTC*
12	Asado de ternera
13	Cerdo asado en el cuello o en el hombro
14	Cerdo LTC*
15	Lomo, fresco
16	Costillas
17	Pierna de cordero con hueso
18	Pollo entero
19	Medio pollo
20	Pechuga de pollo
21	Muslos de pollo, frescos
22	Pato entero
23	Ganso entero
24	Pastel de carne
25	Pescado entero, al grill

26	Filete de pescado
27	Tarta de queso
28	Tarta de manzana
29	Tarta de manzana
30	Pastel de manzana
31	Brownies
32	Magdalenas de chocolate
33	Pastel de hogaza
34	Patatas al horno
35	Porciones
36	Verduras al grill
37	Croquetas congeladas
38	Pomos congelados
39	Lasaña de carne/verdura con platos de fideos secos
40	Patatas gratinadas
41	Pizza fresca y fina
42	Pizza fresca, gruesa
43	Quiche
44	Baguette / chapata / pan blanco
45	Todo el grano / centeno / pan oscuro de grano en molde de pan

*LTC - Cocción a baja temperatura

Cambio de ajustes

-  - seleccione para introducir Menú.
-  - seleccione para introducir Ajustes.
Pulse OK.
- Gire el mando para seleccionar el ajuste.
Pulse OK.
- Ajuste el valor. Pulse OK.
Gire el mando de las funciones de cocción hasta la posición de apagado para salir de Menú.

Menú: Ajustes

La pantalla muestra **0** y un **número** de los ajustes que puede consultar en la tabla.

	Ajuste	Valor
1	Hora	Cambiar
2	Brillo de la pantalla	1 - 5
3	Tono de teclas	1 - Pitido, 2 - Clic, 3 - Sonido desactivado
4	Volumen del timbre	1 - 4
5	Tiempo de funcionamiento	Encendido/Apagado
6	Luz	Encendido/Apagado
7	Calentamiento rápido	Encendido/Apagado
8	Modo demostración	Código de activación. 2468
9	Versión del software	Comprobar
10	Restaurar todos los ajustes	Sí / No

Solución de problemas

Si tiene algún problema con el aparato, consulte el capítulo "Solución de problemas"

en la versión completa del manual del usuario disponible en: www.ikea.com.

Información del producto y hoja de información del producto

Nombre del proveedor	IKEA
Identificación del modelo	FORNEBY 305.577.90 FORNEBY 605.568.88

Para descargar la versión completa, visite www.ikea.com

Índice de eficiencia energética	81.2	
Clase de eficiencia energética	A+	
Consumo de energía con una carga estándar, modo convencional	0.93 kWh/ciclo	
Consumo de energía con una carga estándar, modo de ventilador forzado	0.69 kWh/ciclo	
Número de cavidades	1	
Fuente de energía	Electricidad	
Volumen	72 l	
Tipo de horno	Horno empotrable	
Masa	FORNEBY 305.577.90	33.0 kg
	FORNEBY 605.568.88	33.0 kg
IEC/EN 60350-1 - Aparatos electrodomésticos de cocción - Parte 1: Gamas, hornos, hornos de vapor y grills - Métodos de medida del rendimiento.		



867376512-A-462022

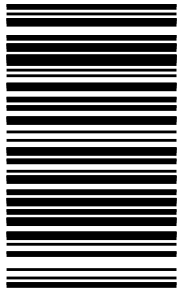

© Inter IKEA Systems B.V. 2022

21552

AA-2350300-1