

12

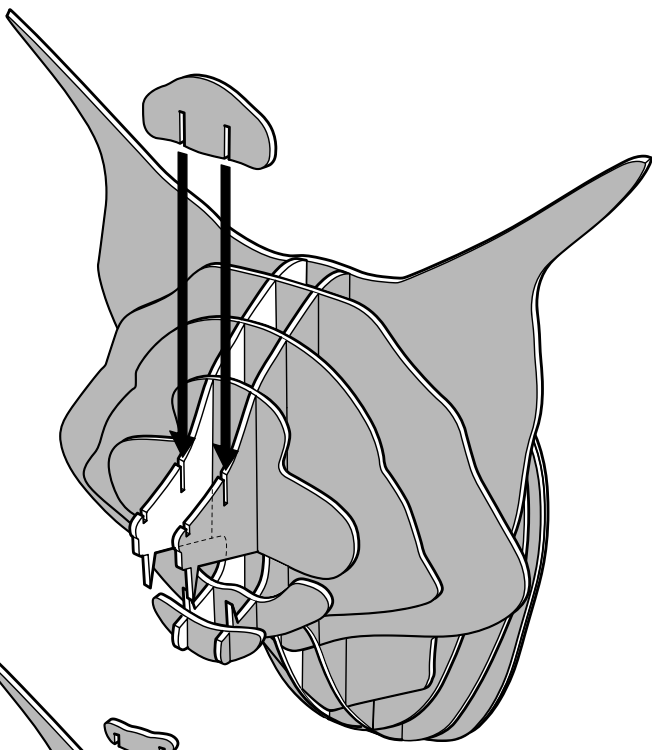

13

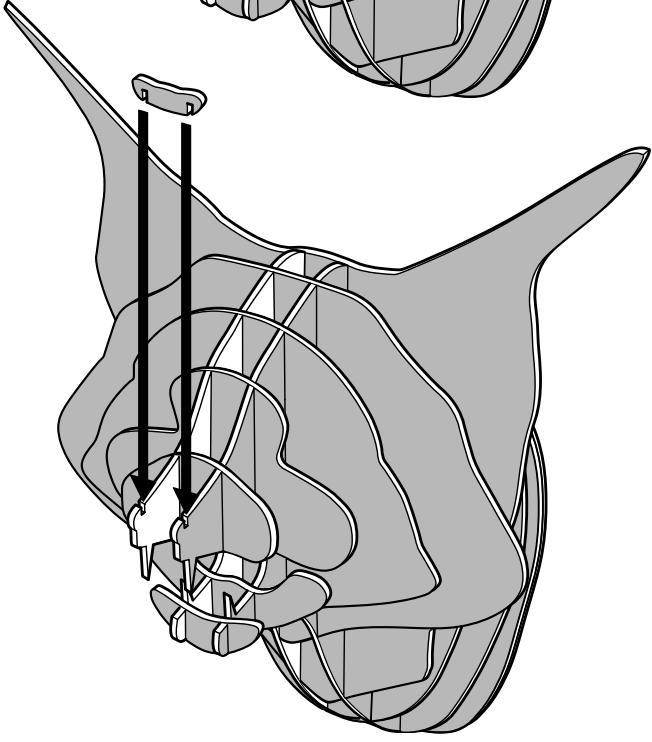

GILTIG

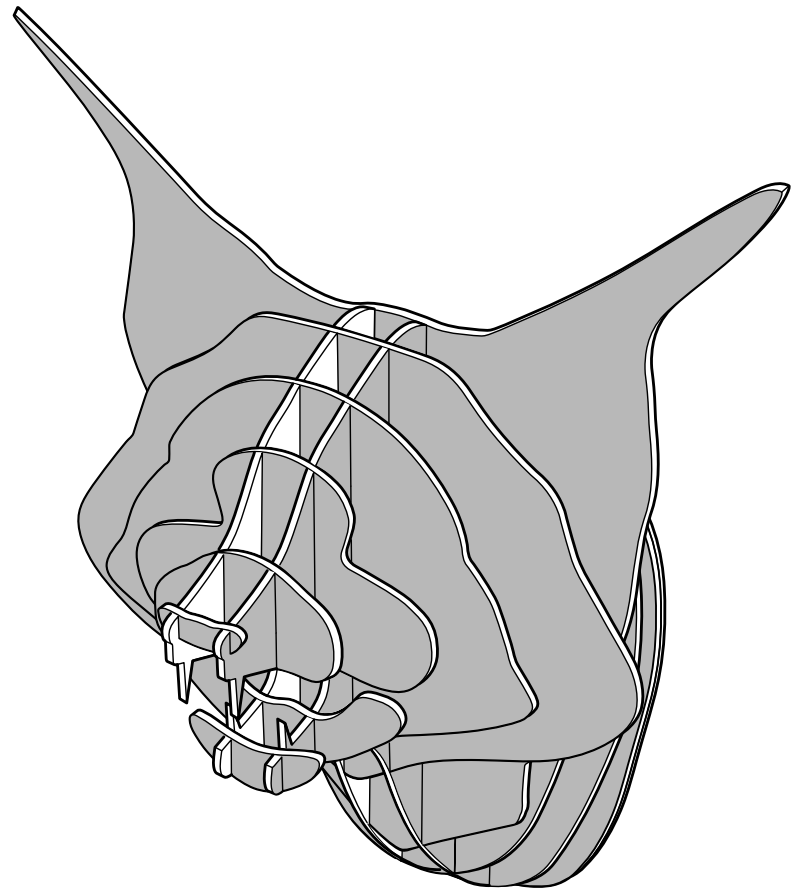

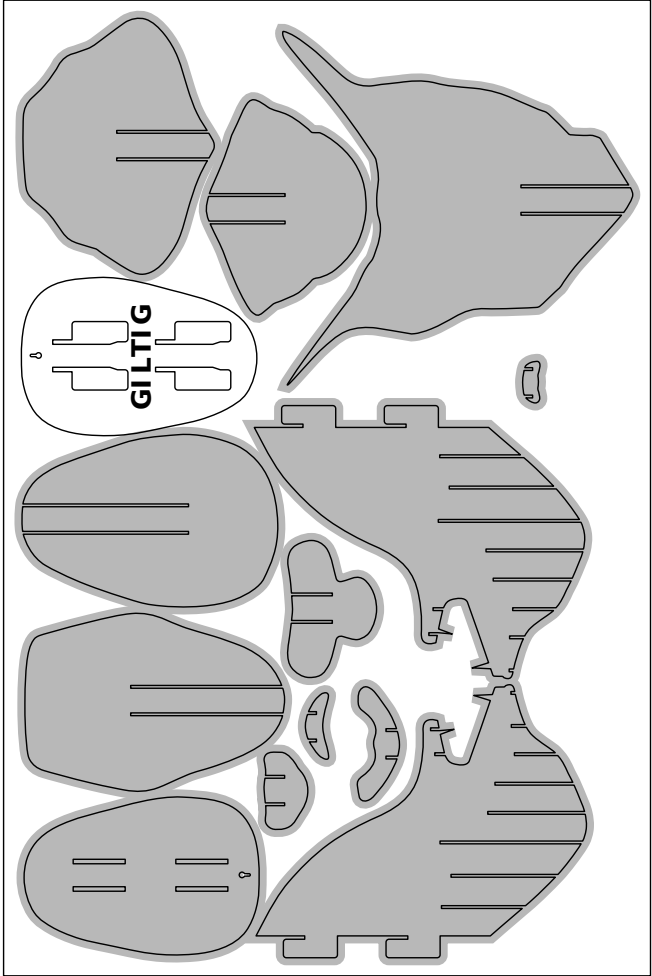
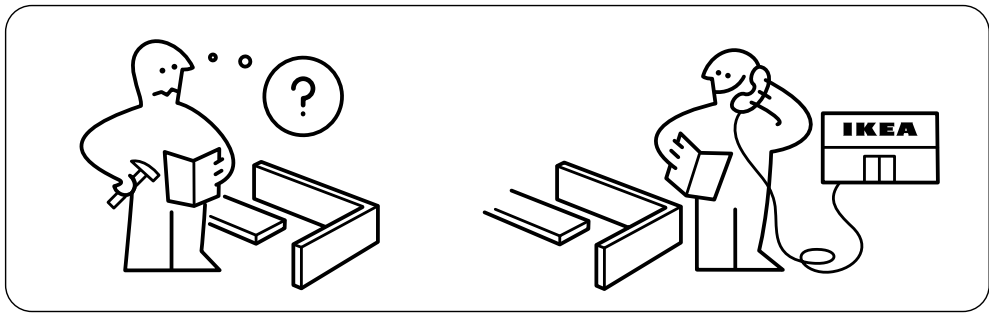

1x

10

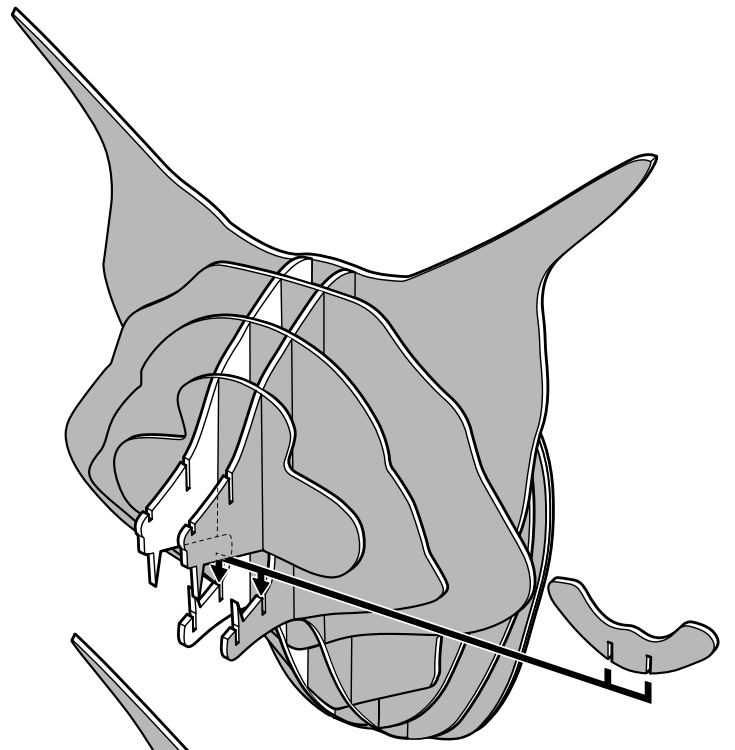

11

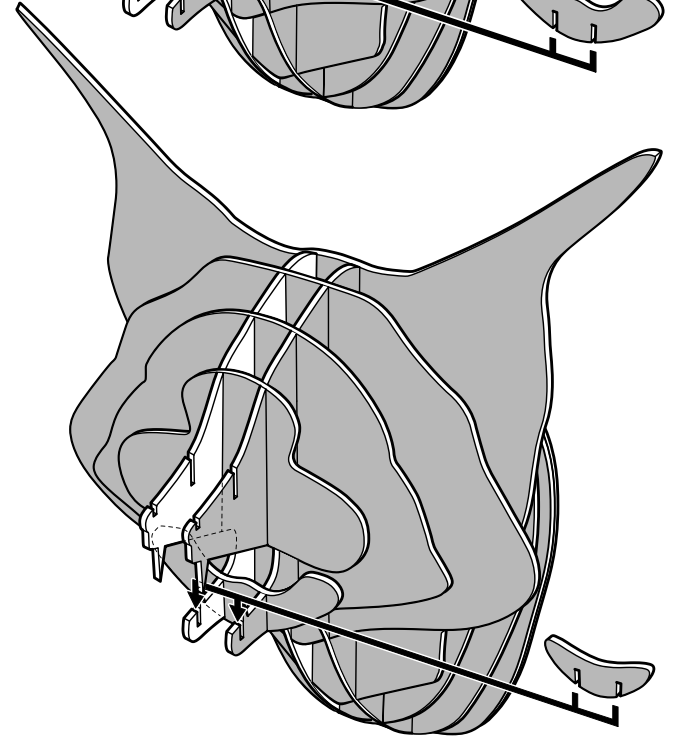

9

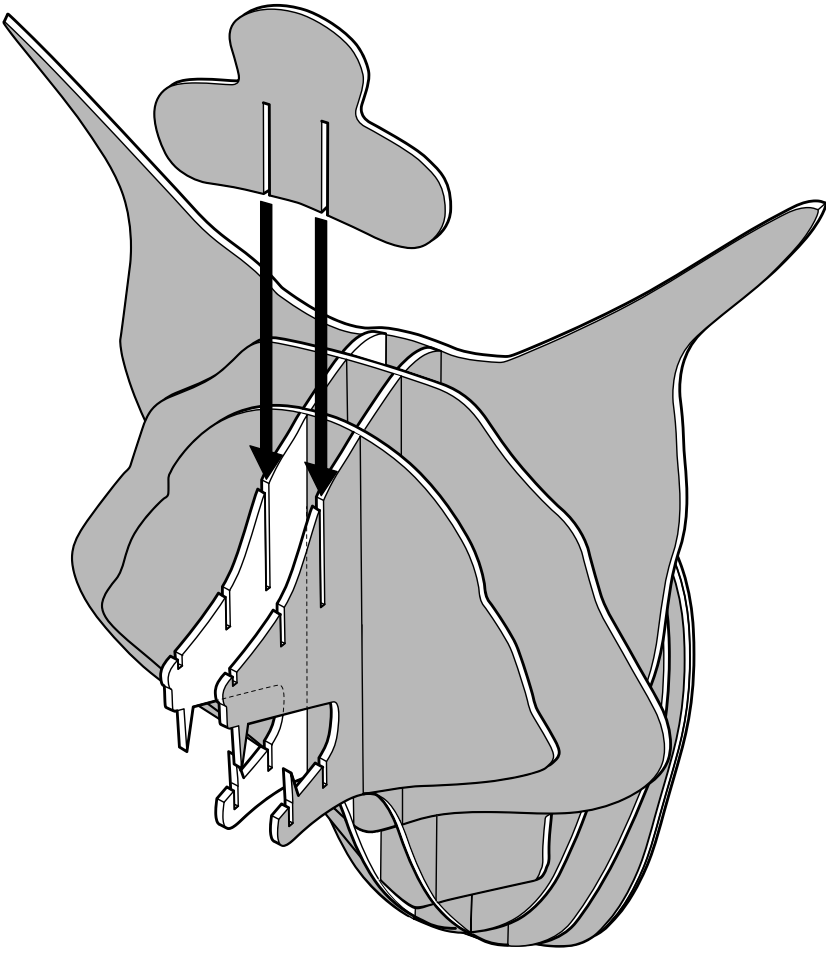

1

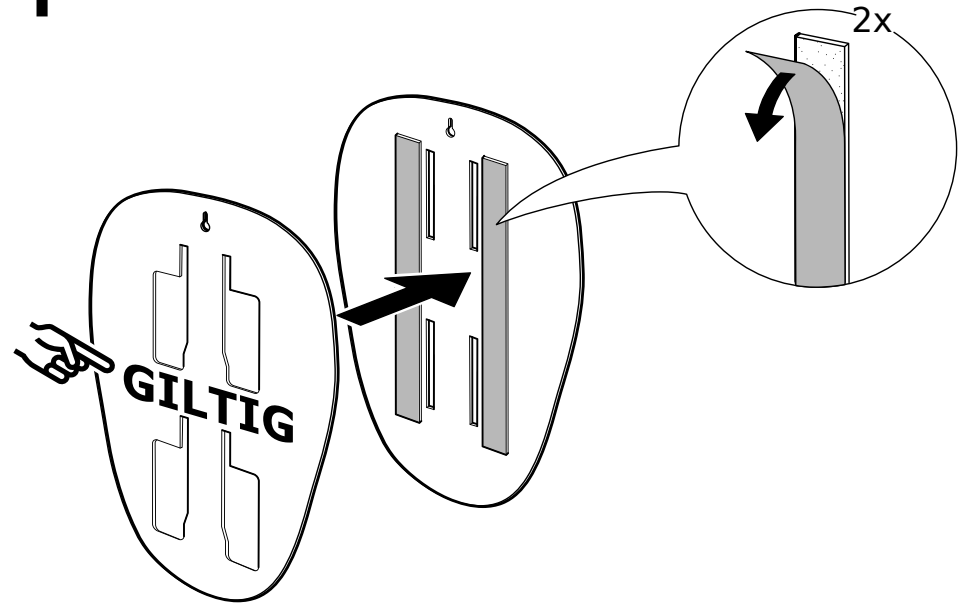

2

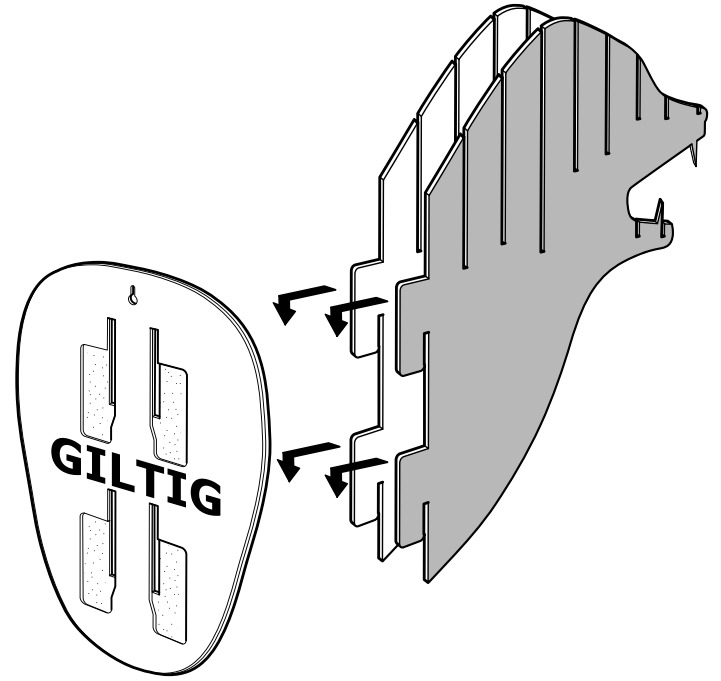

3

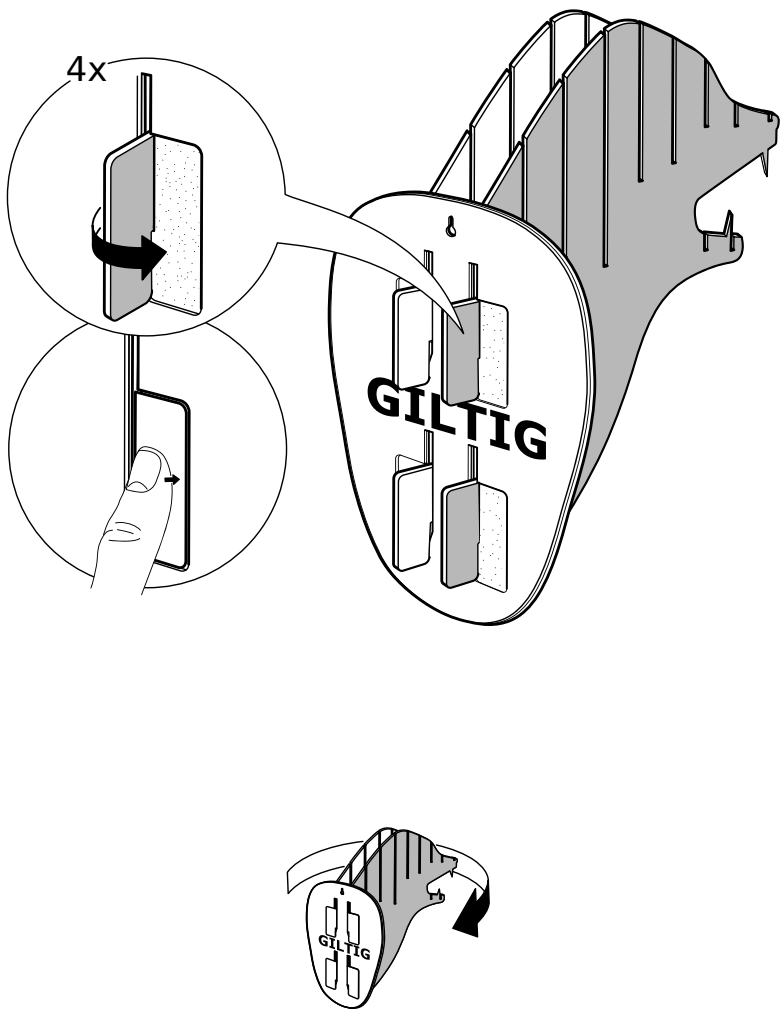

8

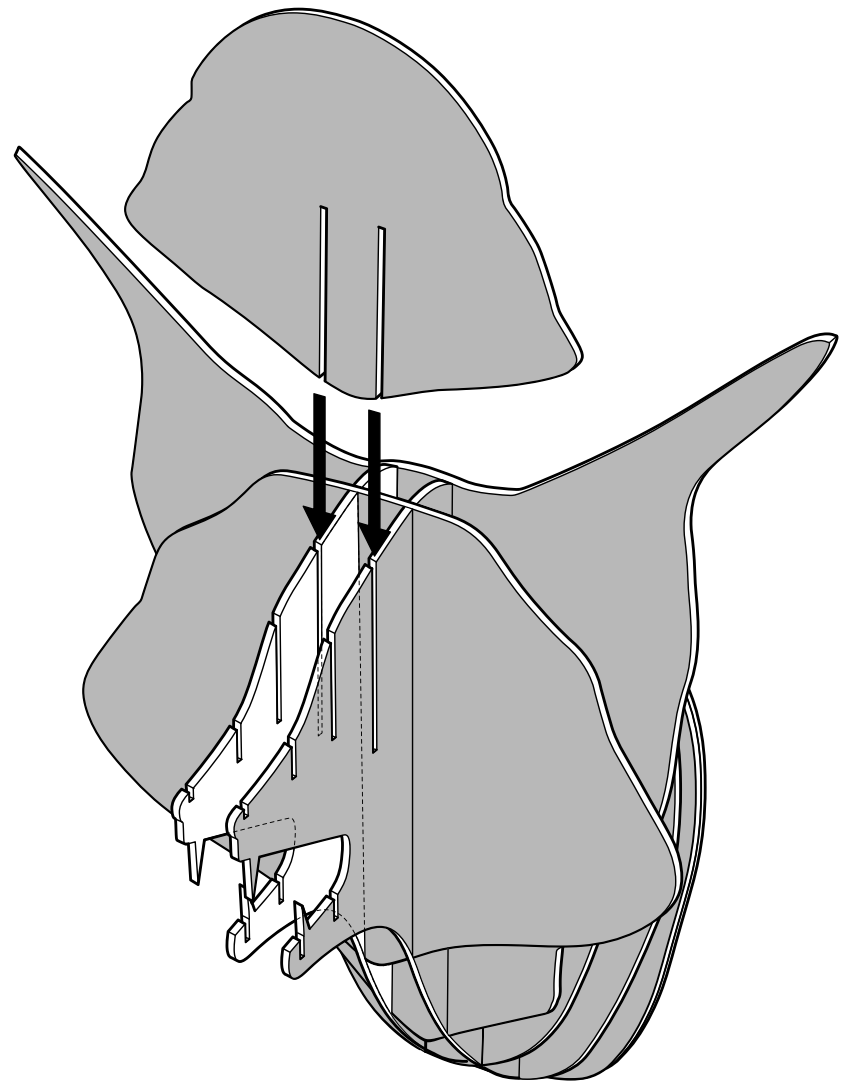

7

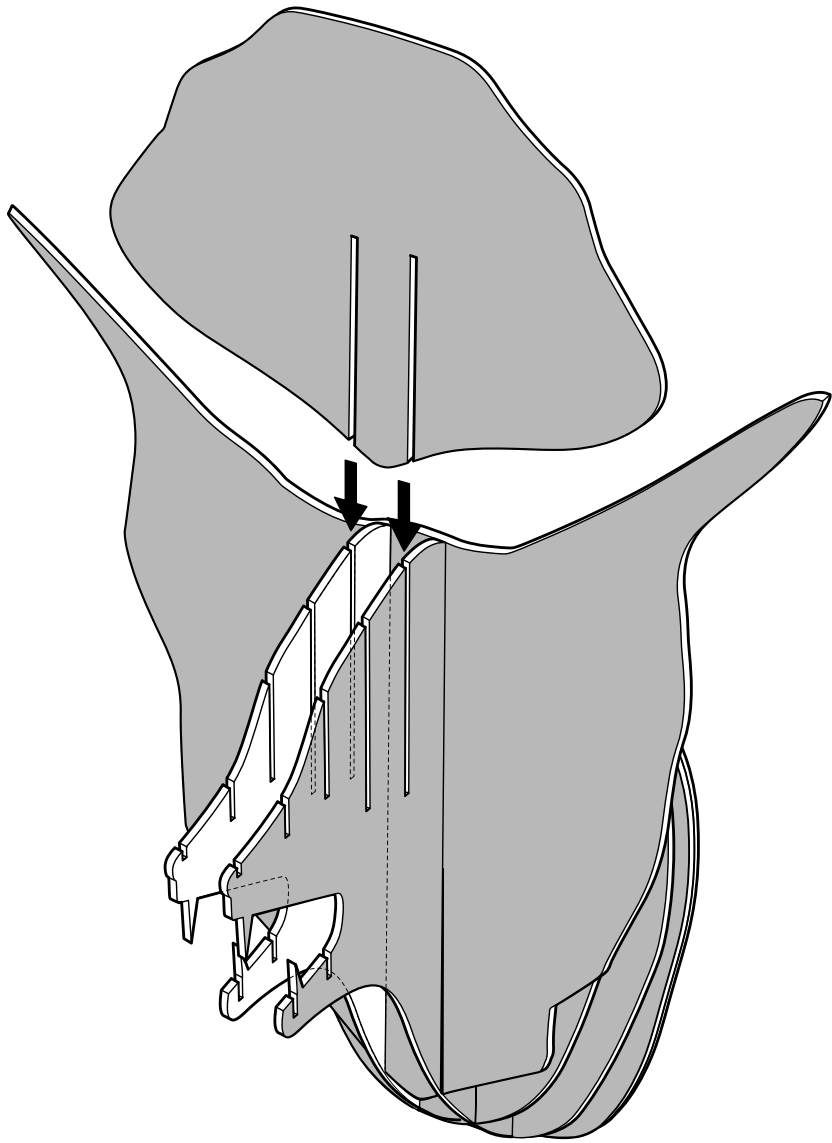

4

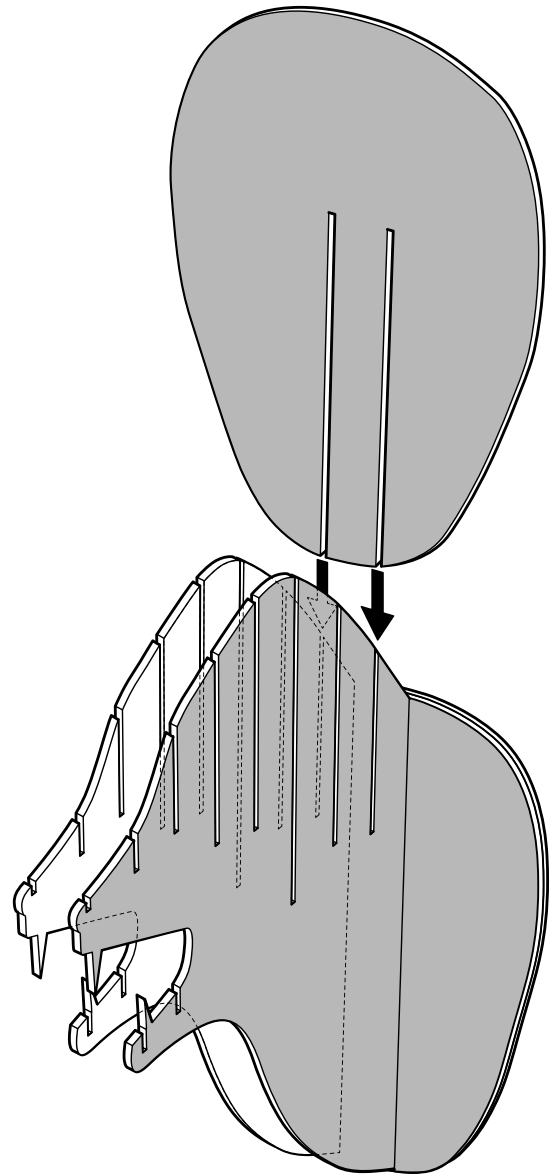

5

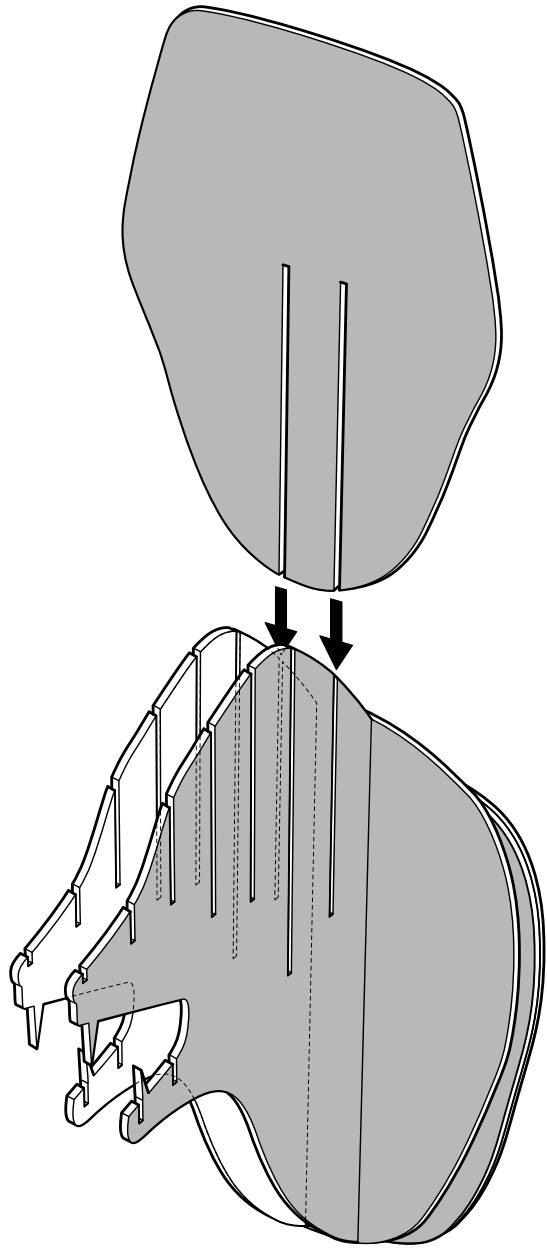

6

