

IKEA PS 2014

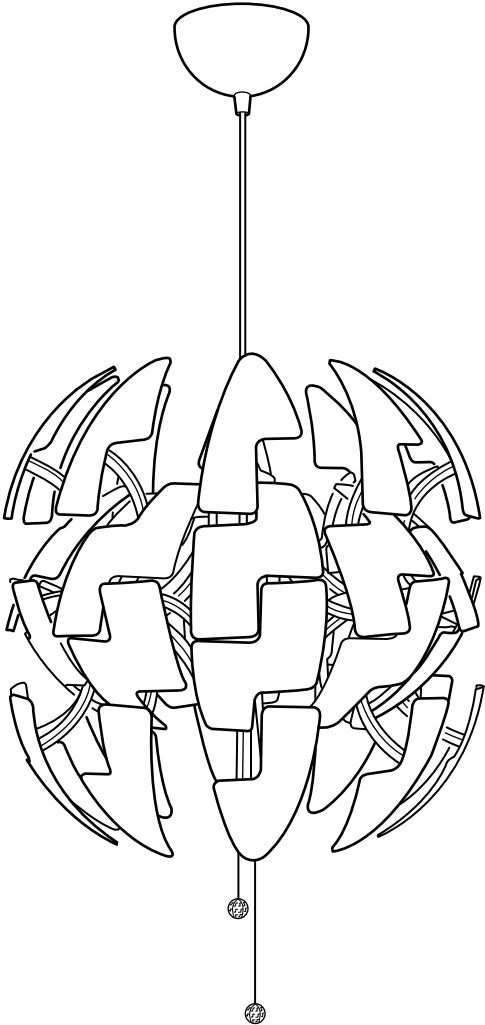

Design and Quality
IKEA of Sweden



ENGLISH
INSTALLATION INSTRUCTIONS

CAUTION:

Before starting, turn off power at main circuit panel.

FRANÇAIS
INSTRUCTIONS D'INSTALLATION

ATTENTION:

coupez l'alimentation avant de procéder à l'installation.

ESPAÑOL
INSTRUCCIONES DE MONTAJE

ADVERTENCIA:

Antes de comenzar el montaje, cortar la luz en el cuadro general.

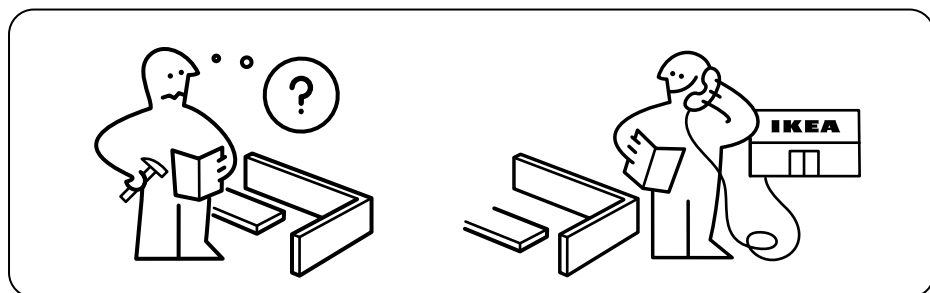

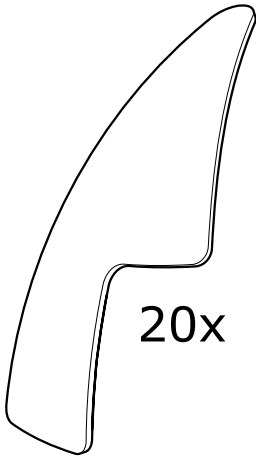

20x

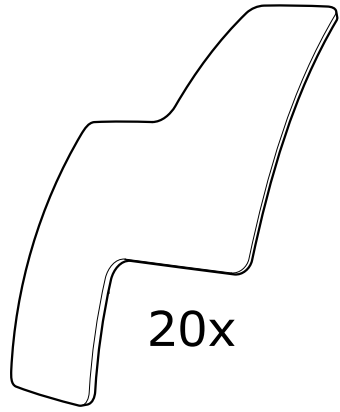

20x

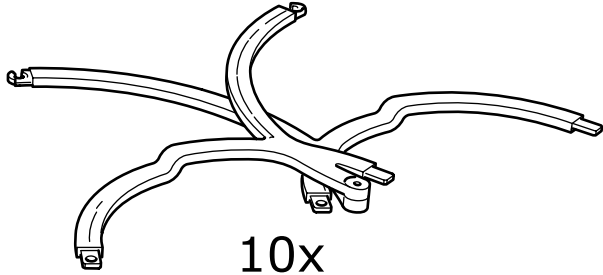

10x

1

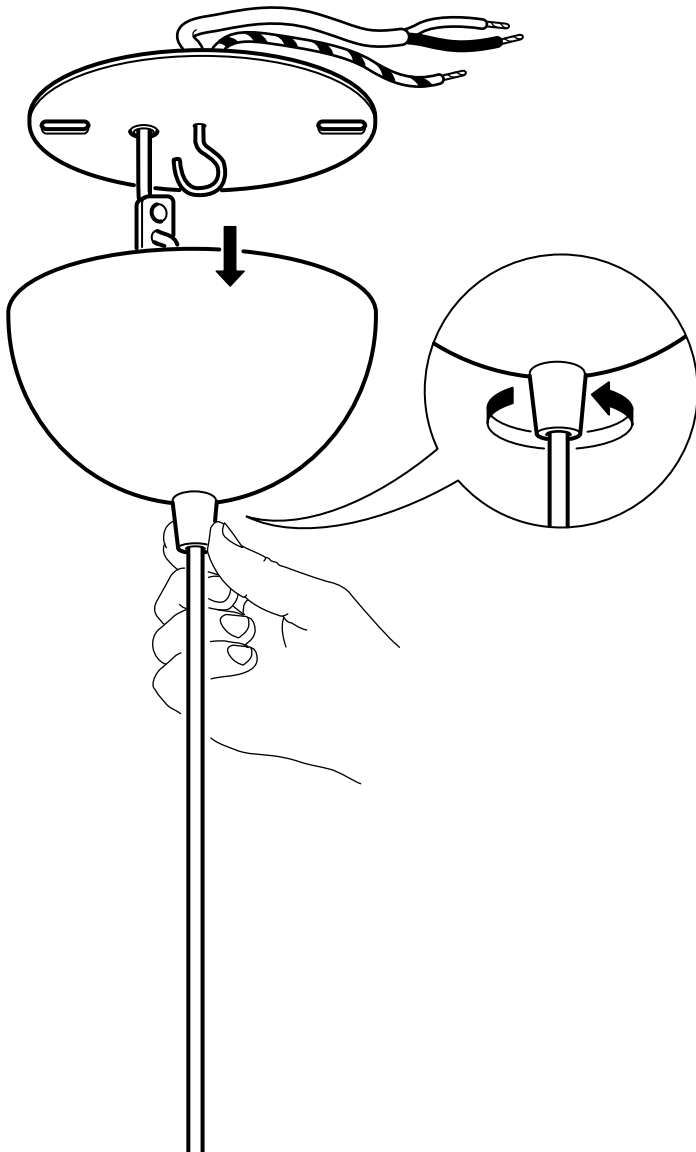

2

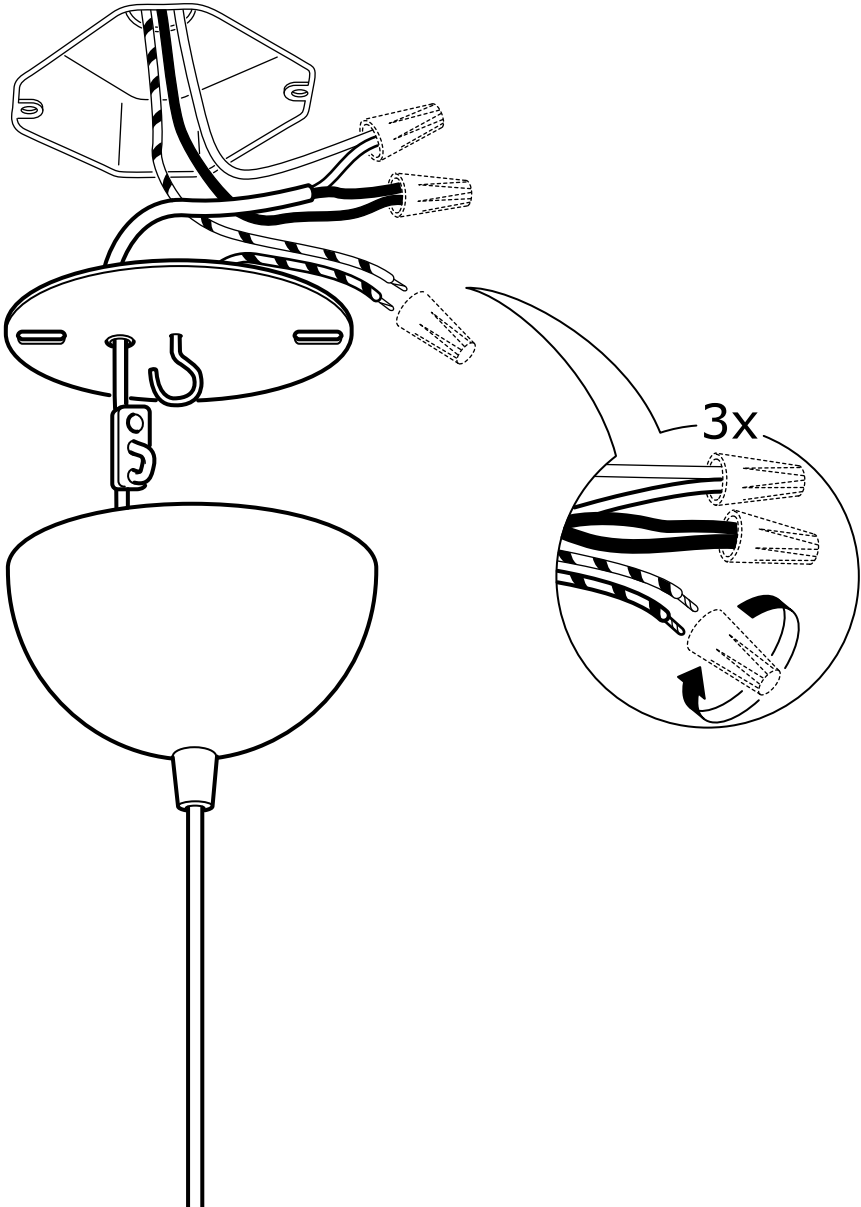

3

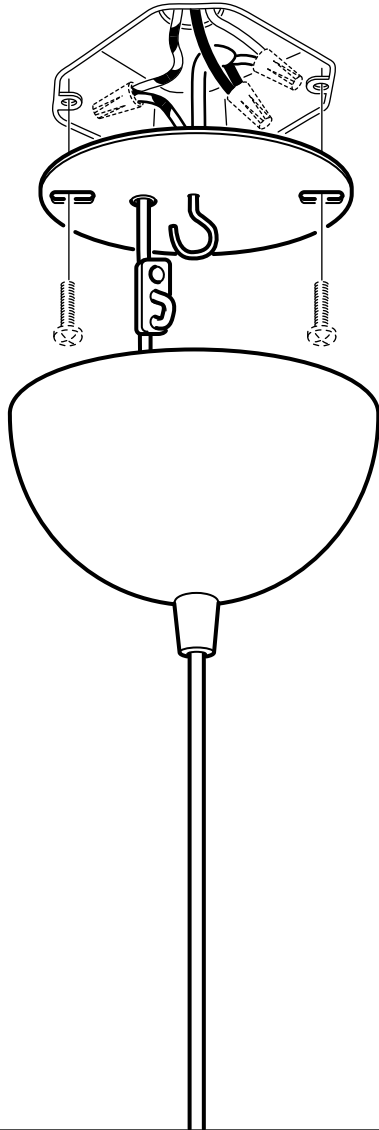

4

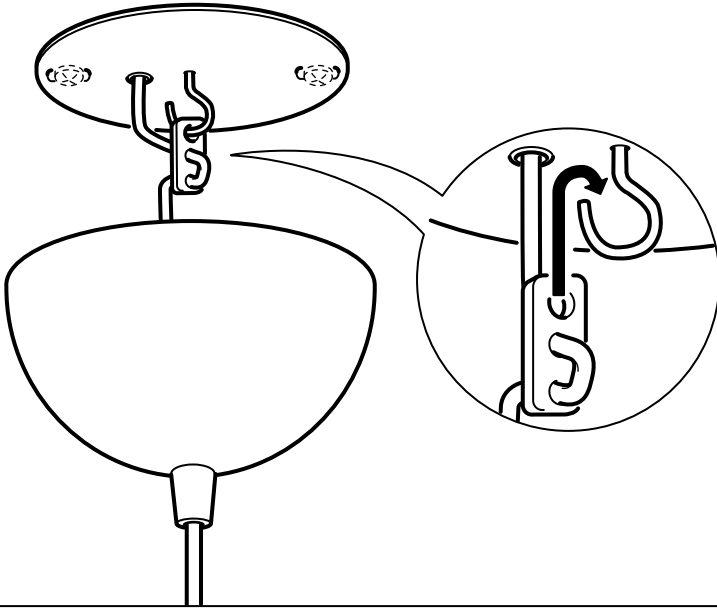

5

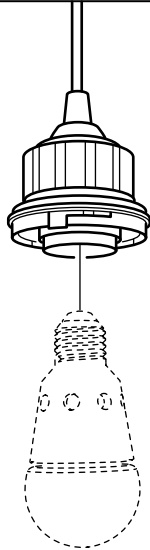

6

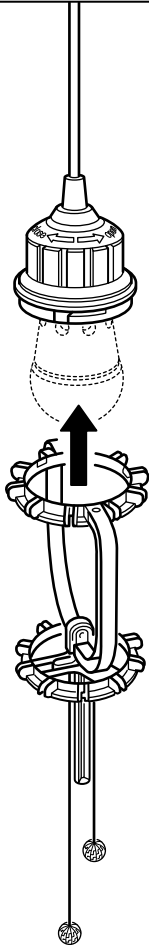

7

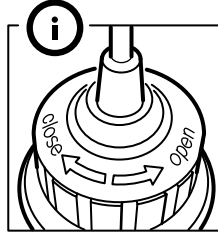

CLICK!

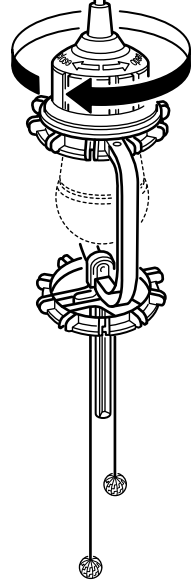

8

i

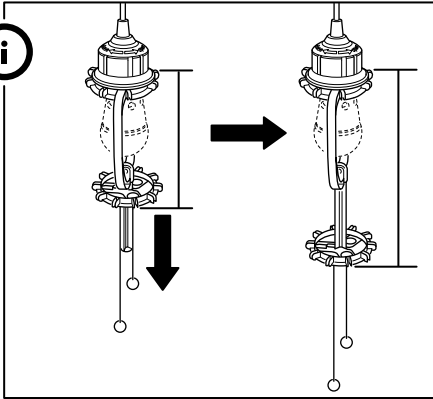

10x

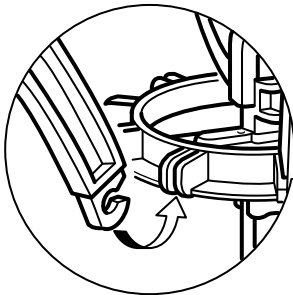
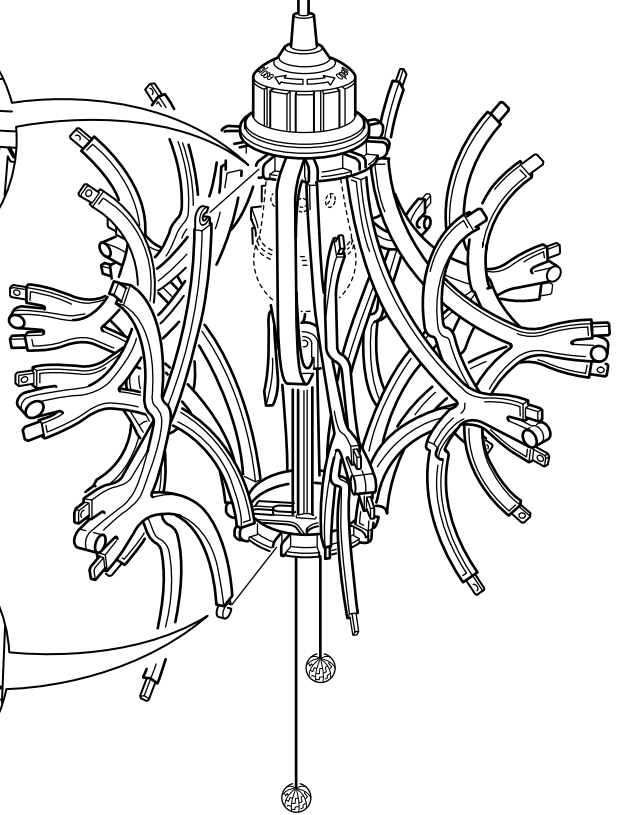
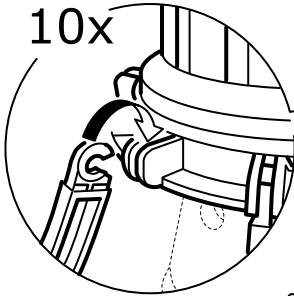

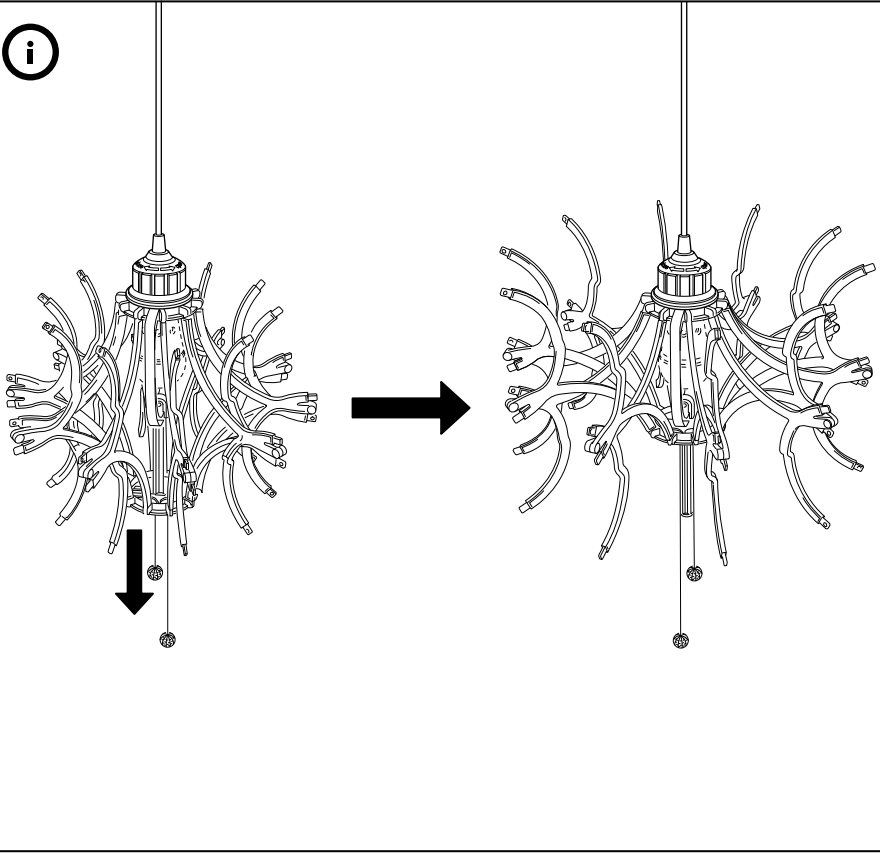

9

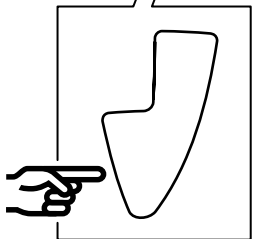
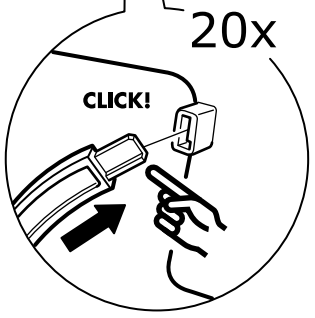
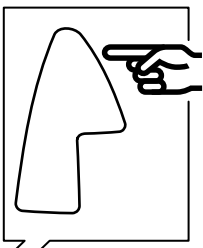
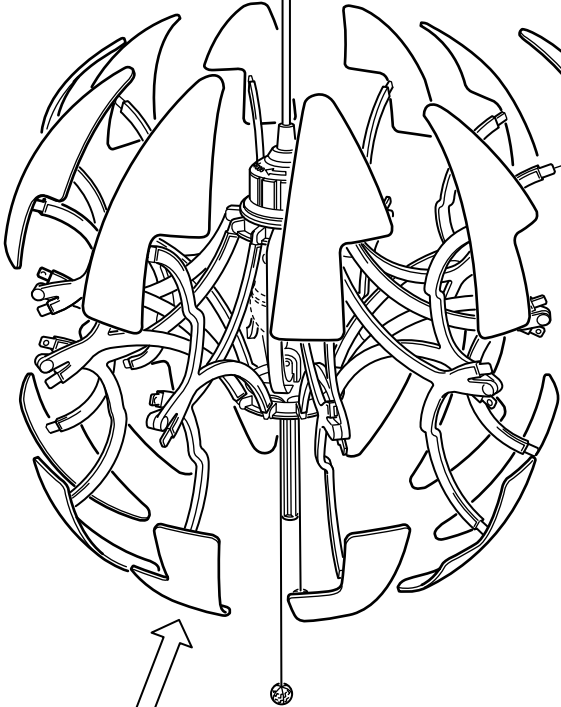

10

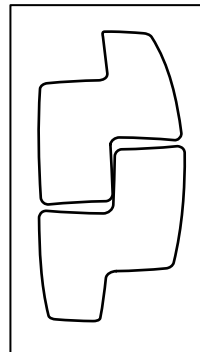
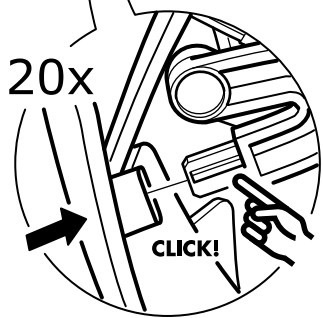
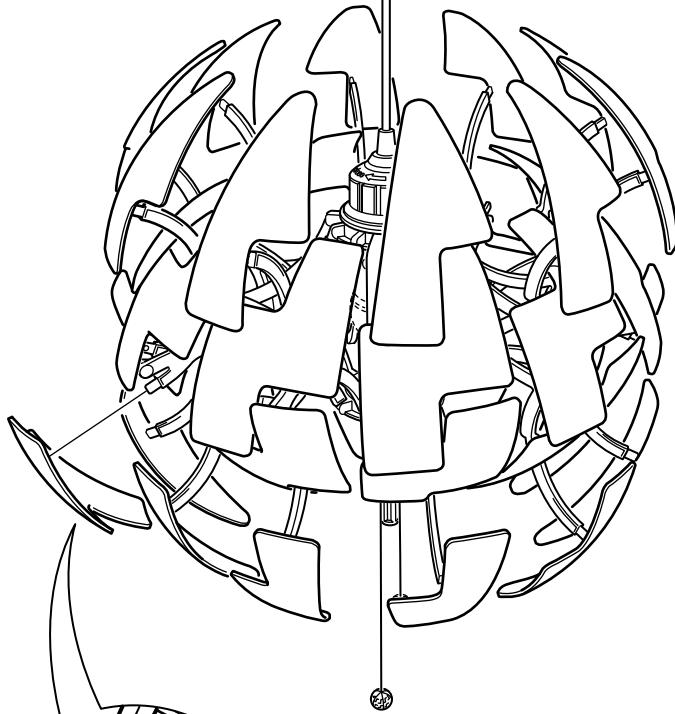

i

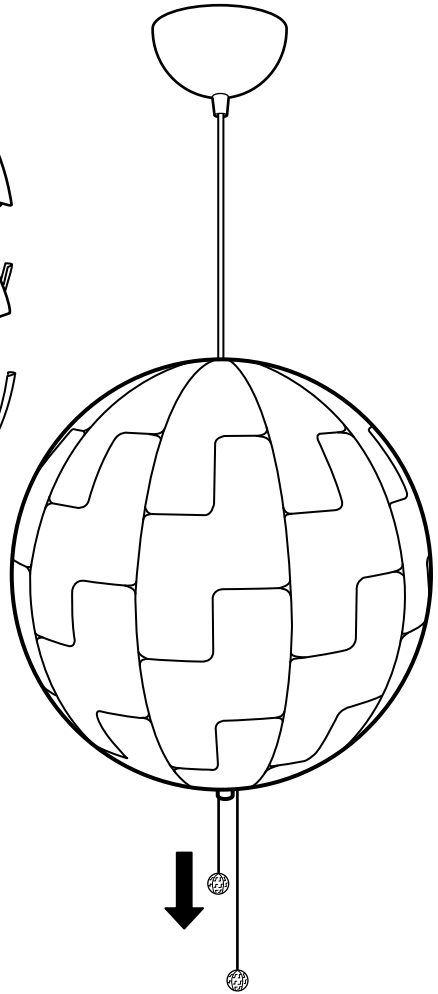
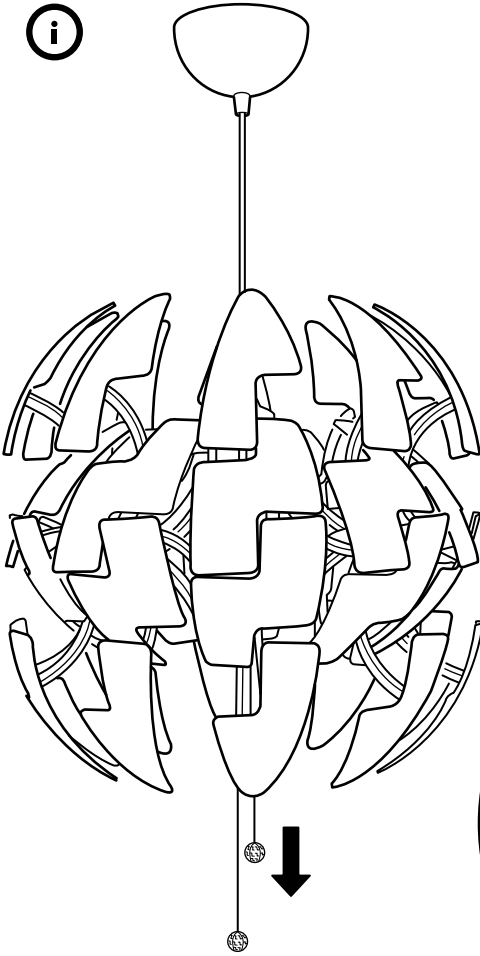

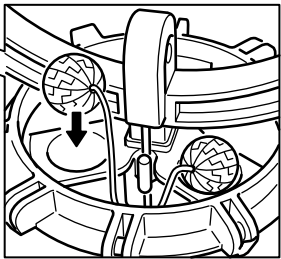
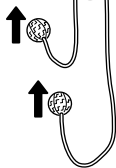
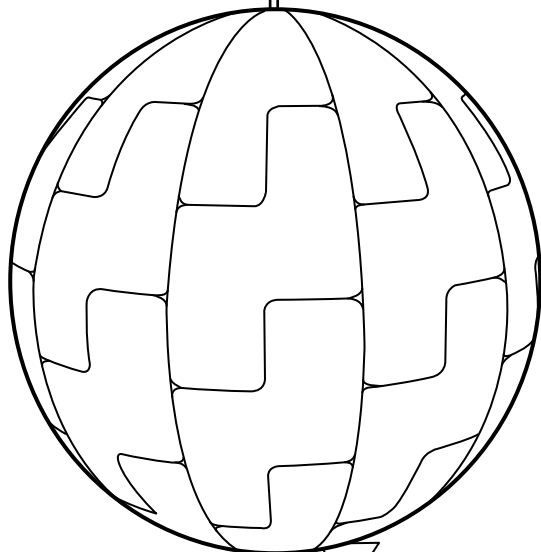

i

