

# KLIPPAN

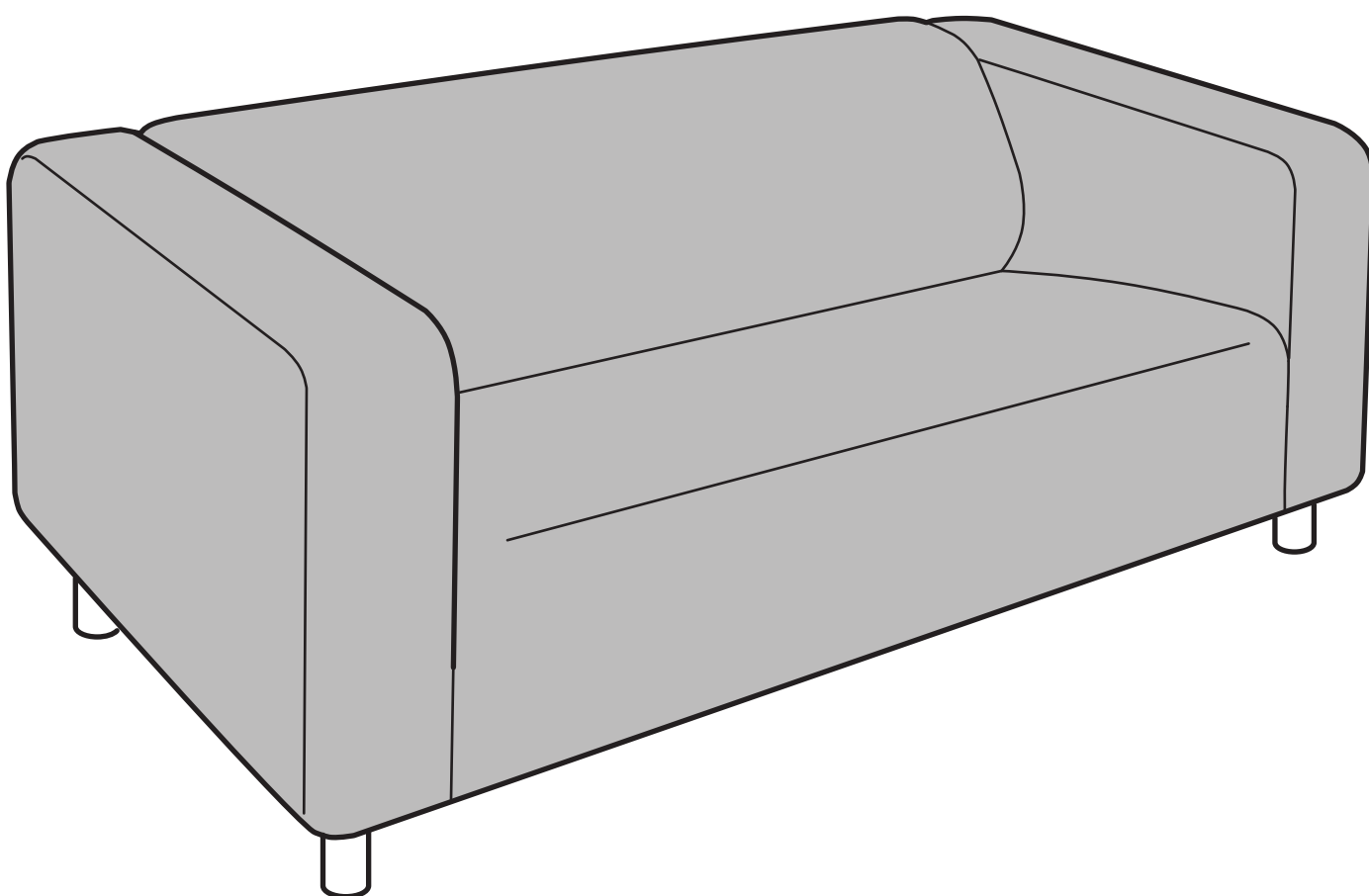

Design and Quality  
IKEA of Sweden

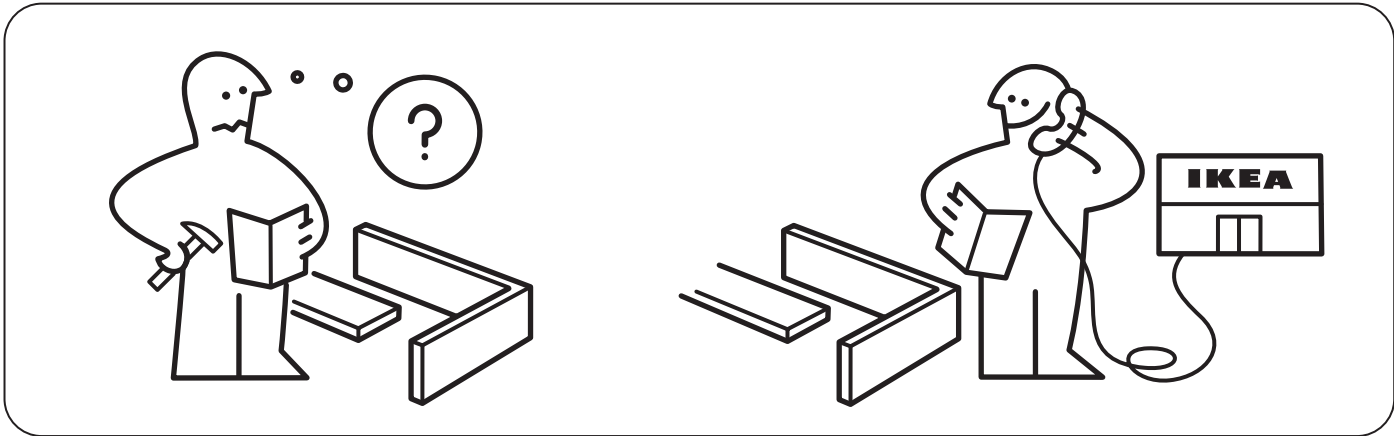

1

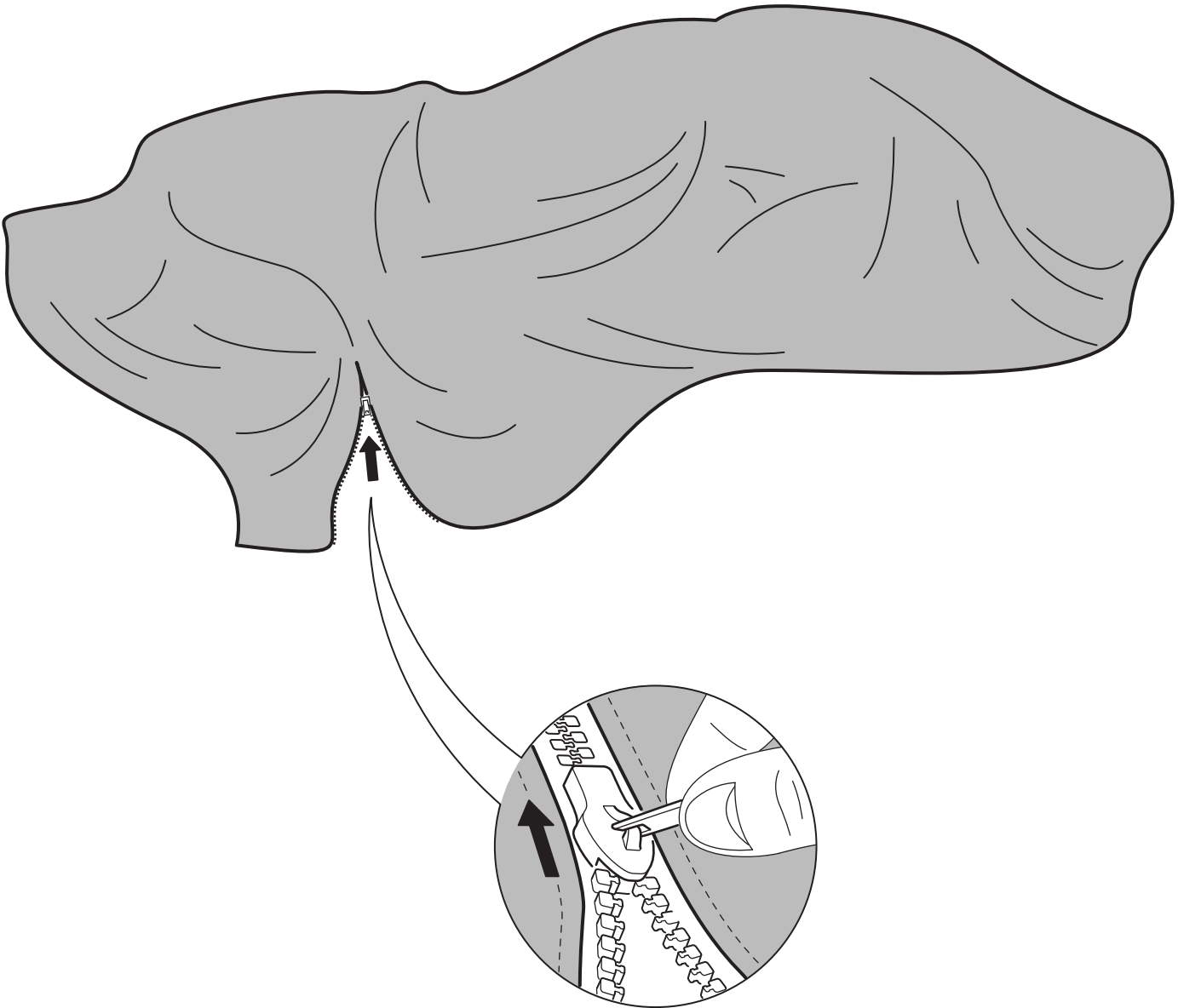

**2**

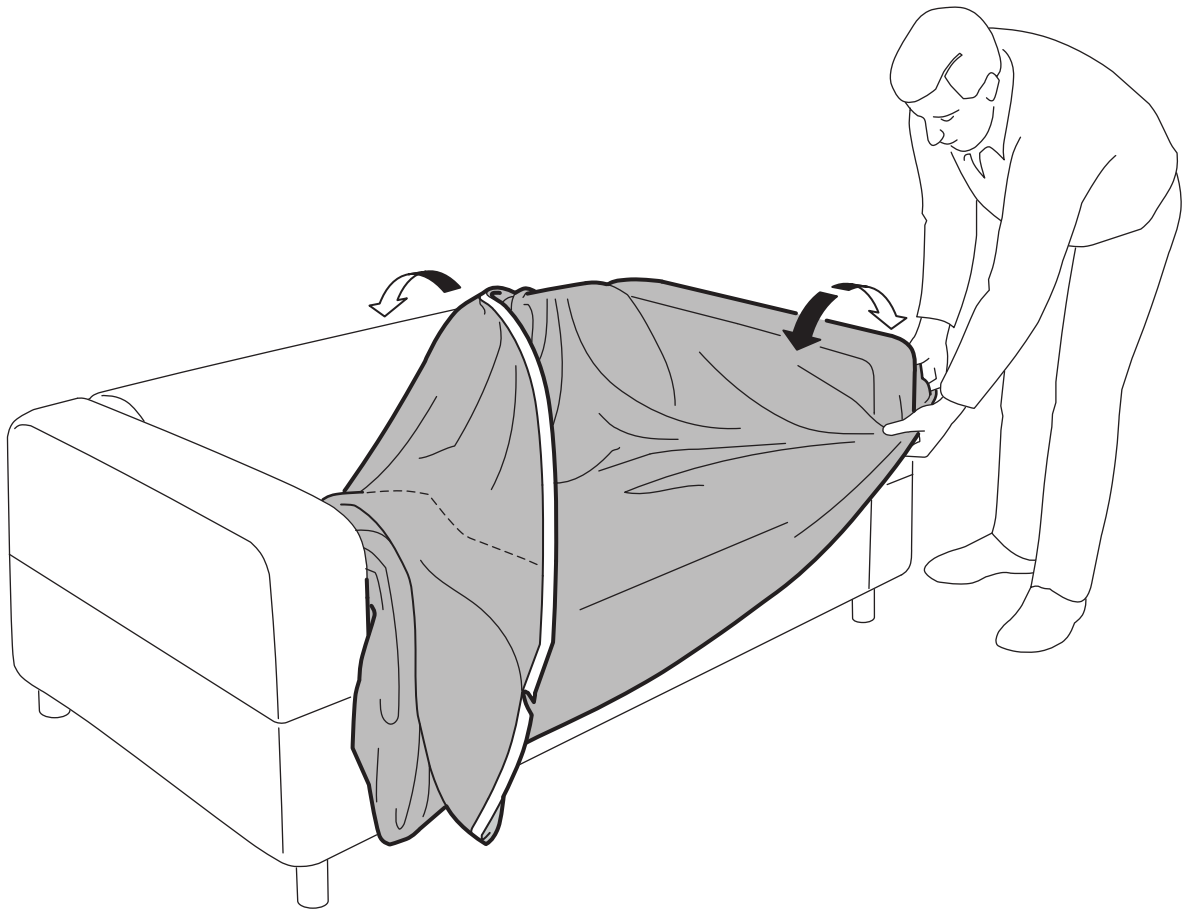

**3**

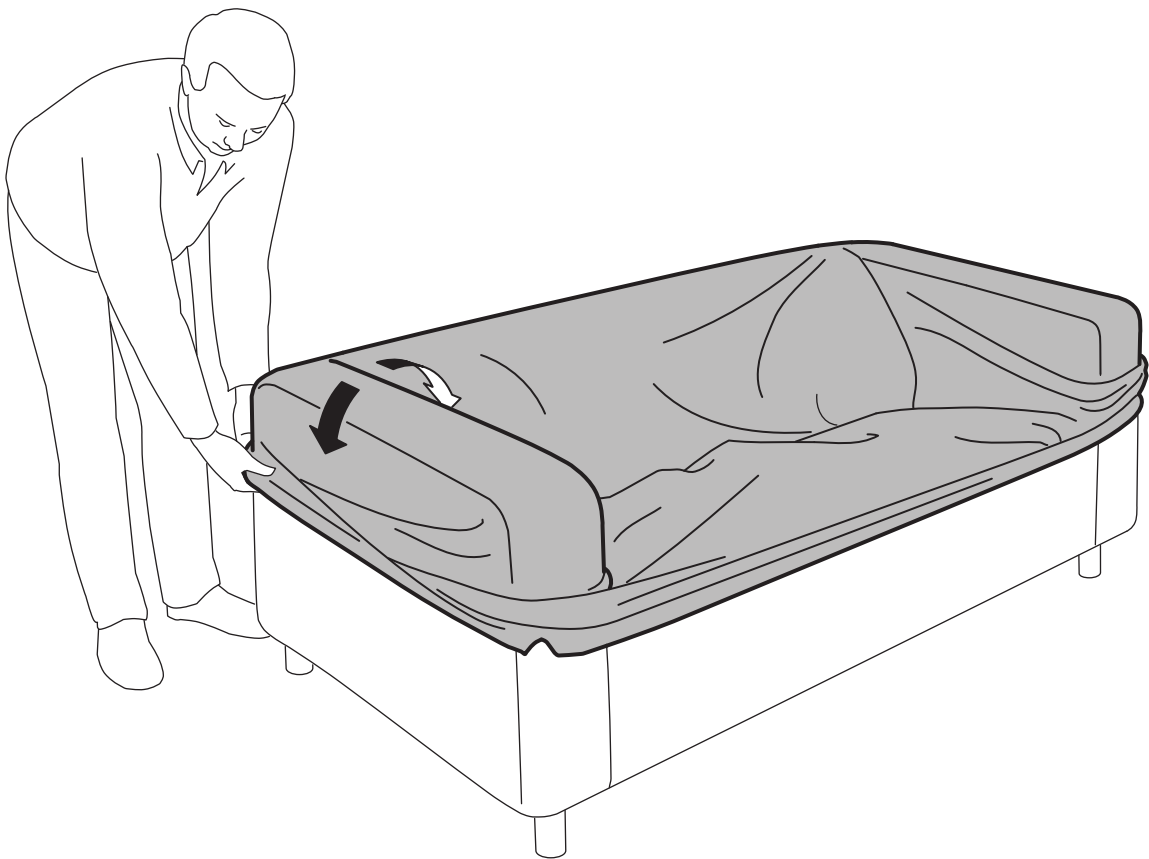

4

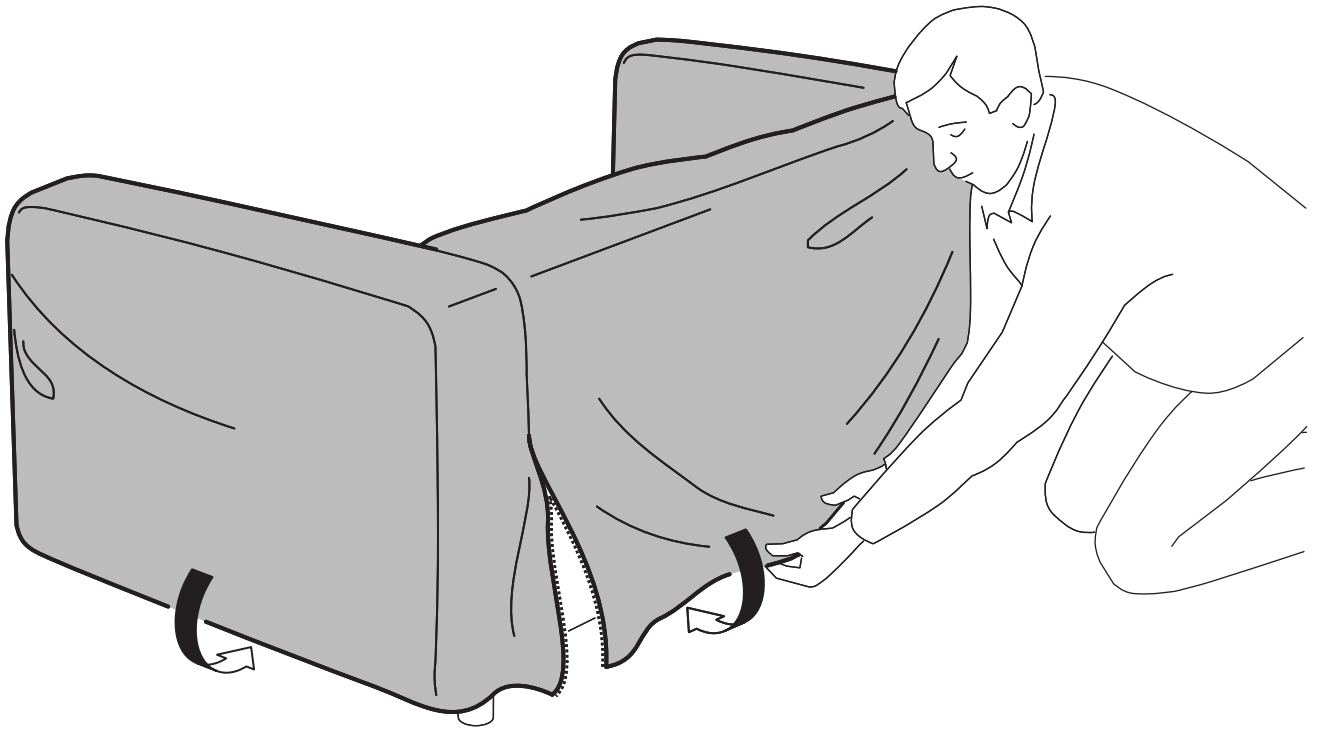

5

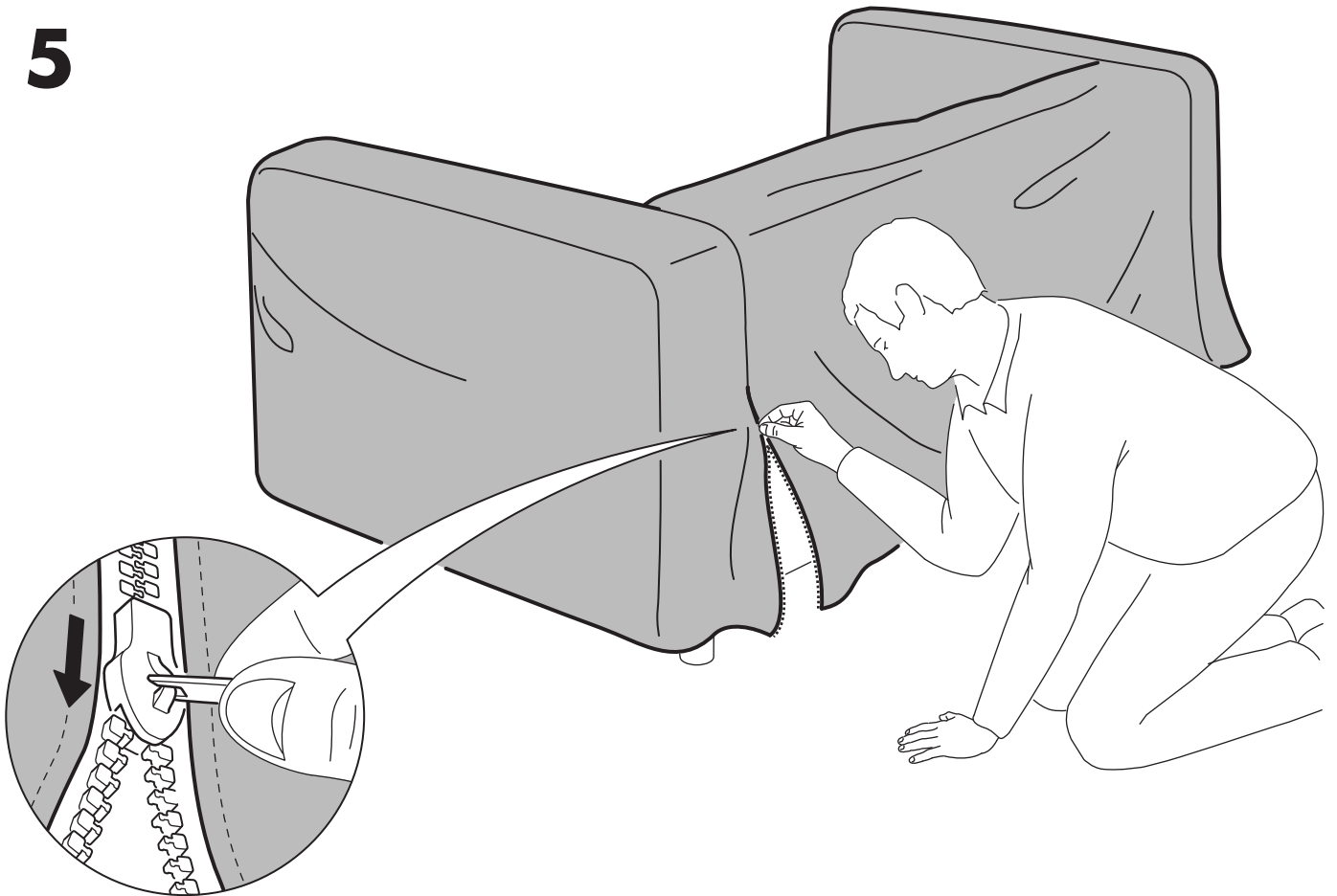

**6**

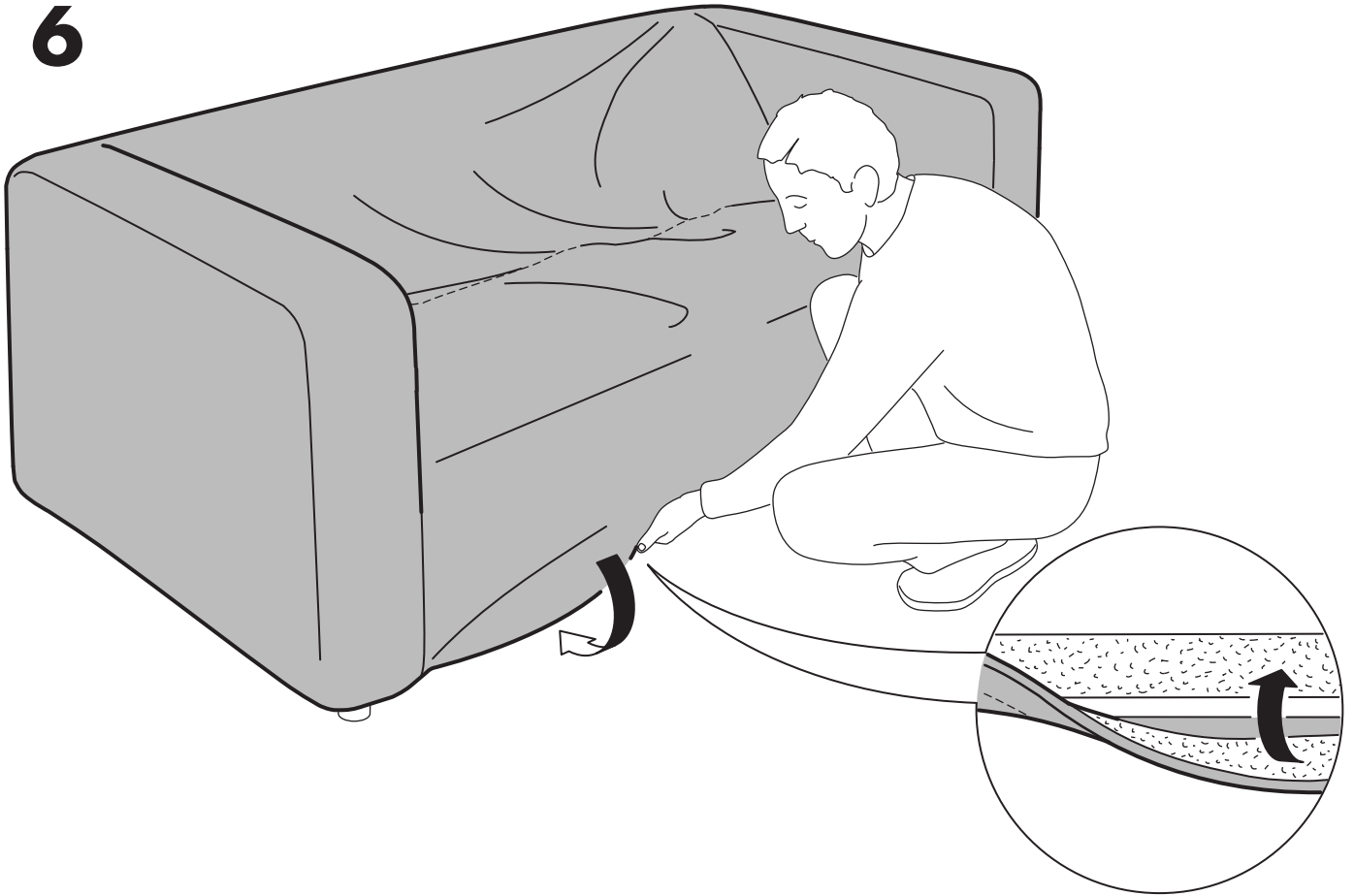

**7**

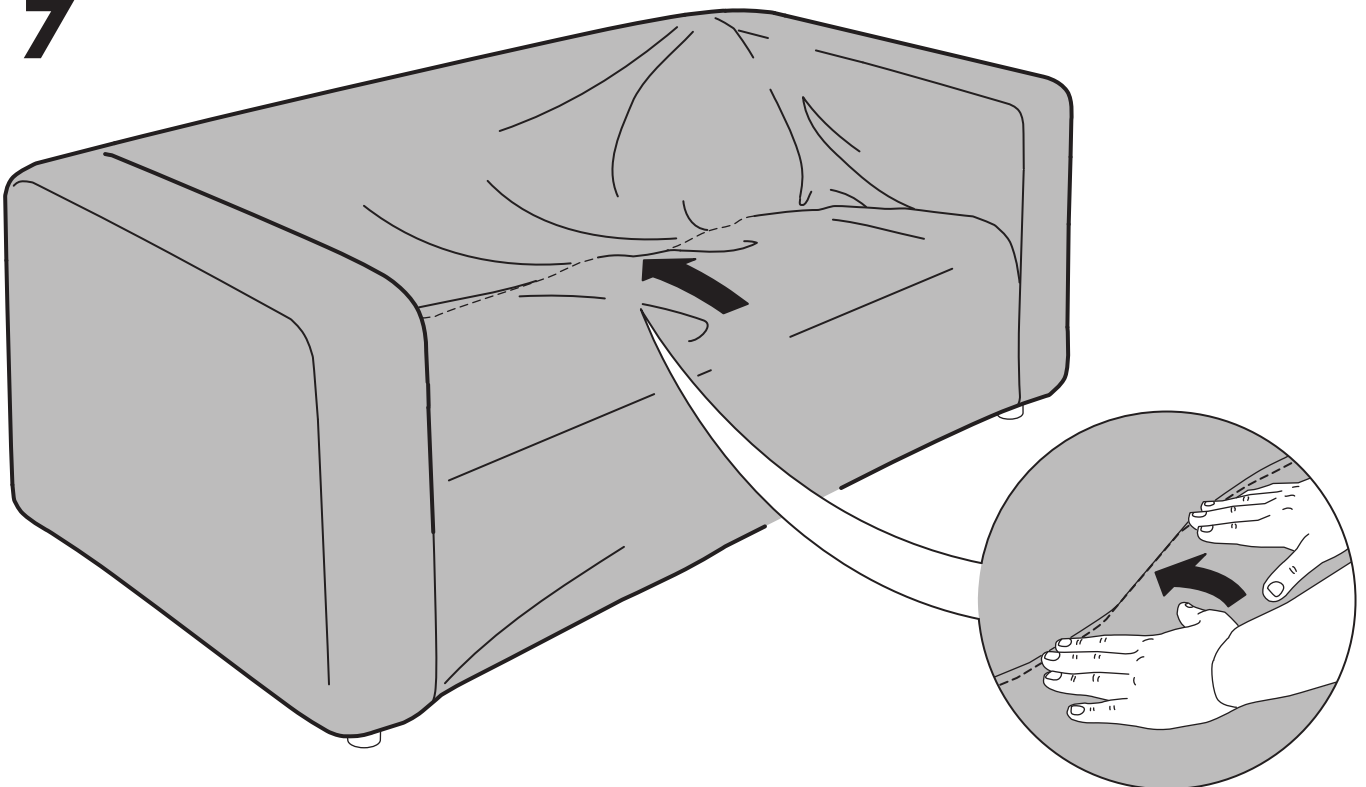

8

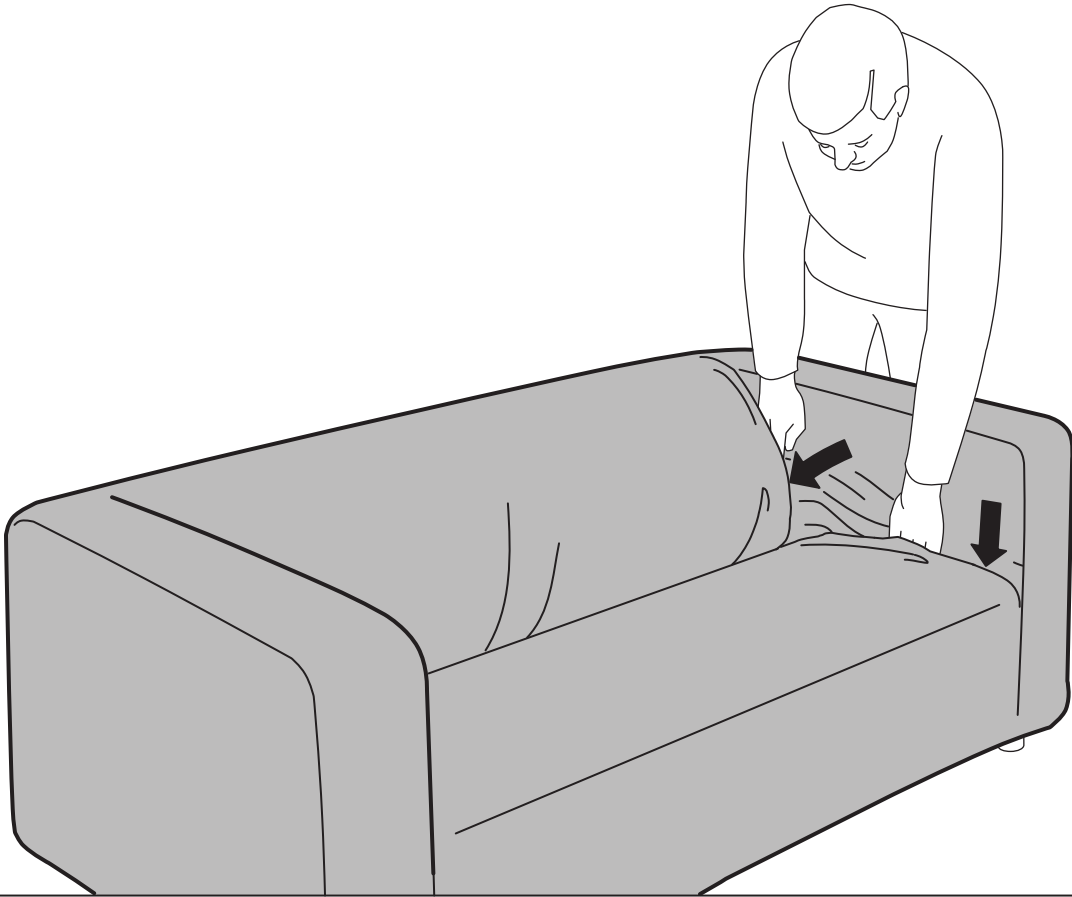

9

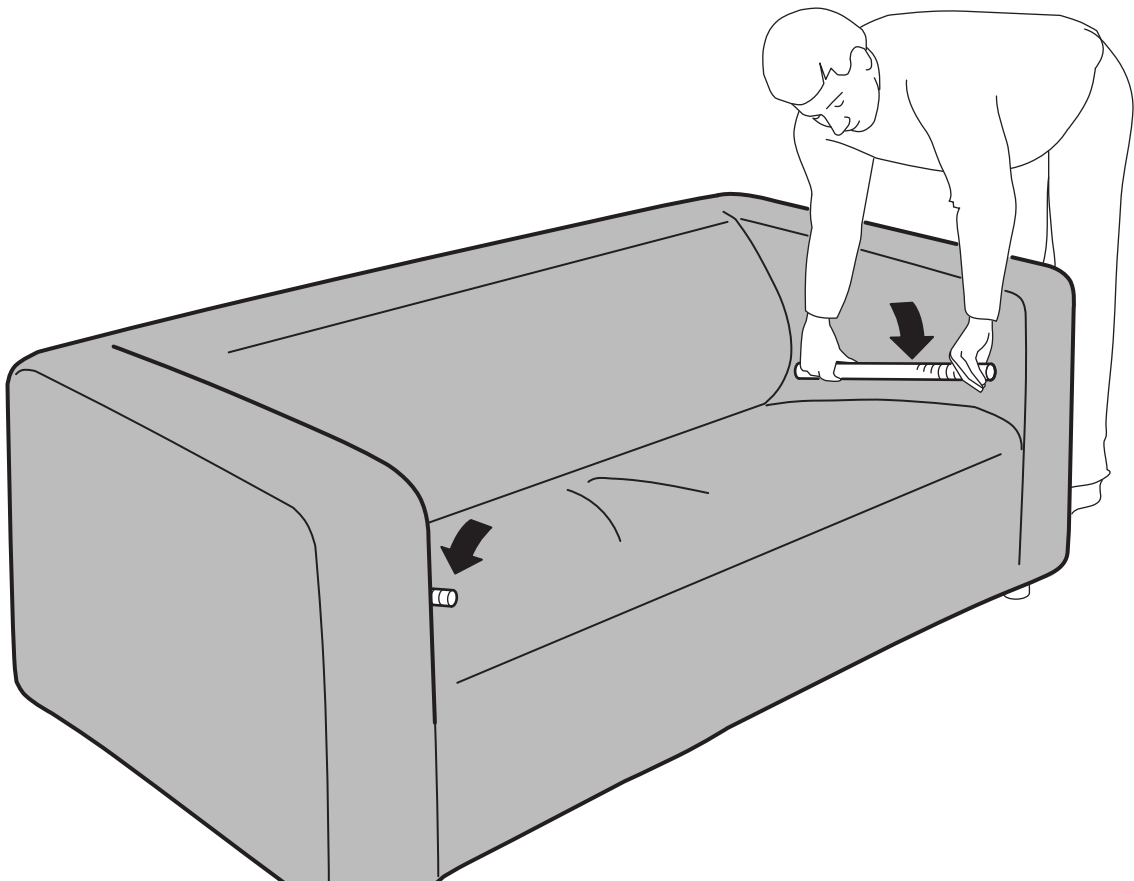

10

