

i

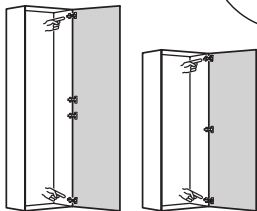

i

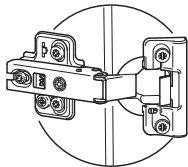
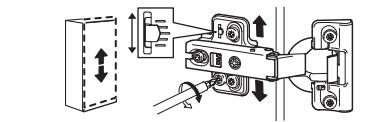
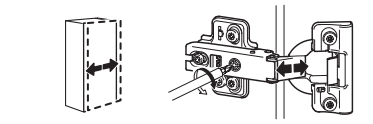
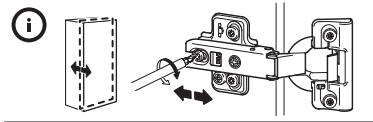

i

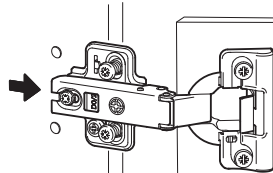
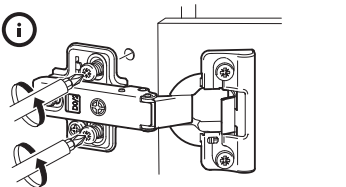

# KOMPLEMENT

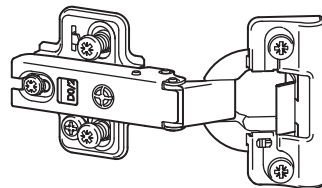

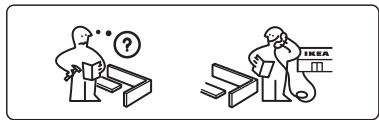

1x

104663

1

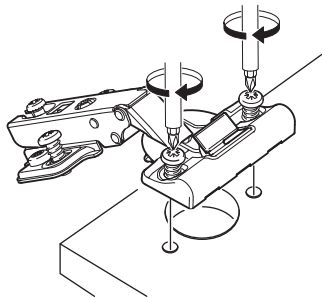

2

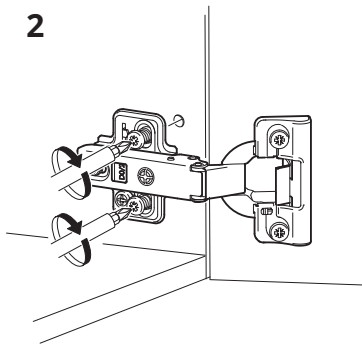

3

