

English

Wipe clean with a soft cloth dampened in water and a mild non-abrasive washing-up detergent or soap, if necessary. Wipe dry with a clean cloth.

How to handle your products with protective film

- Before assembly, remove protective film from edges and other surfaces which may interfere with assembly.
- Leave remaining protective film to avoid damage during assembly. After assembly, remove all protective film.
- Note – surfaces may be extra sensitive to scratches immediately after removing the protective film.
- To further improve resistance to scratches, wipe surfaces with a mild soap solution (max. 1%, no alcohol or abrasives).

Deutsch

Mit einem in Wasser angefeuchteten weichen Tuch und, wenn nötig, mit schleifmittelfreiem Reinigungsmittel oder Seifenlösung säubern. Mit einem sauberen Tuch abtrocknen.

Behandlung von Produkten mit Schutzfolie

- Vor der Montage die Schutzfolie von der Kante und anderen Oberflächen entfernen, wo sie bei der Montage störend sein könnte.
- Die übrige Schutzfolie am Produkt belassen, um Schäden beim Montieren zu vermeiden. Die Schutzfolie nach der Montage komplett entfernen.
- Bitte beachten - direkt nach Entfernen der Schutzfolie kann die Oberfläche besonders empfindlich gegen Kratzer sein.
- Zur Erhöhung der Strapazierfähigkeit die Oberfläche mit einem weichen Tuch und einer milden Seifenlauge (max. 1%; keine alkohohaltigen Mittel oder Schleifmittel) abwischen.

Français

Nettoyer à l'aide d'un chiffon doux imbibé d'eau et, si besoin, d'un détergent non abrasif ou de savon. Essuyer avec un chiffon propre.

Que faire du film protecteur sur les produits.

- Avant le montage, retirer le film de protection qui pourrait gêner, notamment au niveau des coins ou sur certaines surfaces.
- Laisser le film de de protection s'il ne gêne pas, afin d'éviter tout risque de dommages lors du montage. Après le montage, retirer tout le film protecteur.
- Attention : une fois le film retiré, la surface craint particulièrement les rayures.
- Pour renforcer la résistance à l'usure, nettoyer à l'aide d'un chiffon doux trempé dans de l'eau savonneuse (max. 1 % de détergent).

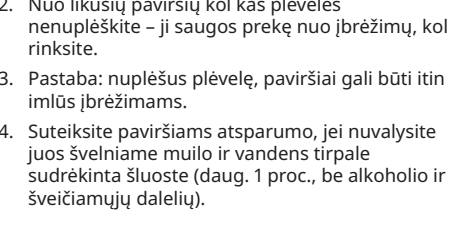
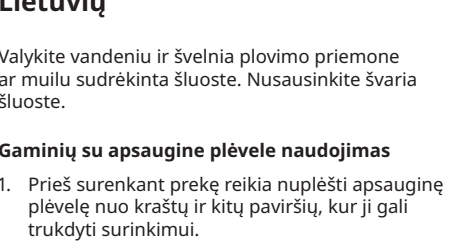
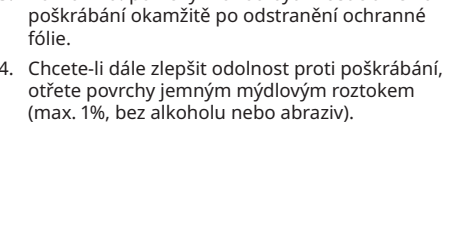
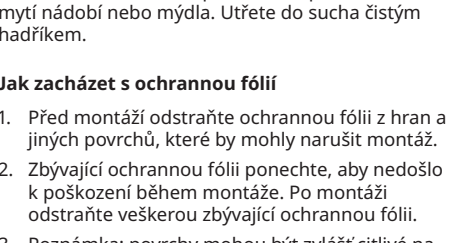
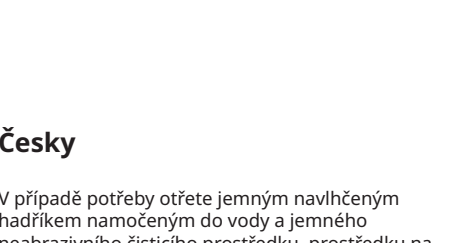

Nederlands

Schoonmaken met een vochtig doekje met water en evt. een schoonmaakmiddel zonder schuurmiddel, of een zeepoplossing. Nadrogen met een droge doek.

Omgaan met producten met beschermfolie

- Voor de montage: verwijder de beschermfolie van de randen en andere oppervlakken die de montage kunnen belemmeren.
- Laat de resterende beschermfolie zitten om beschadigingen tijdens de montage te voorkomen.
- Let op - oppervlakken kunnen meteen nadat de beschermfolie verwijderd is extra gevoelig zijn voor krassen.
- Om de slijtvastheid nog verder te verbeteren, de oppervlakken afnemen met een milde zeepoplossing (max. 1 %, geen alcohol of schuurmiddel).

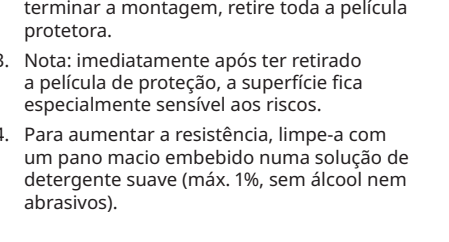
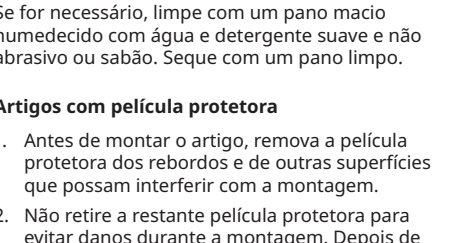
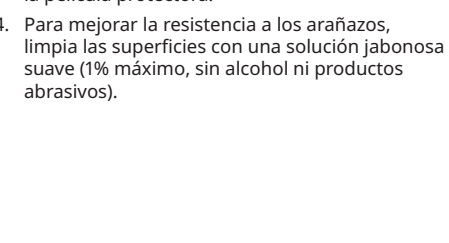
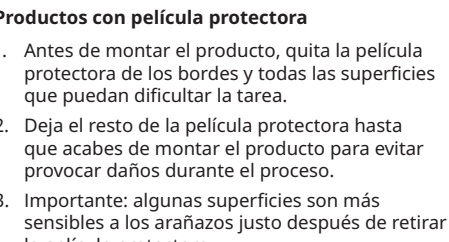
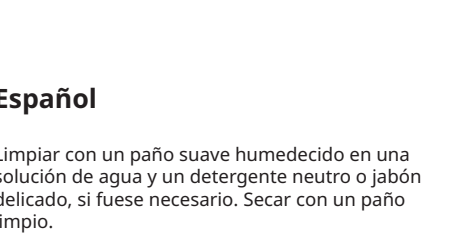

Dansk

Tørres eventuelt af med en blød, fugtig klud tilsat et mildt, ikke-slibende opvaskemiddel eller sæbe. Tør efter med en ren, tør klud.

Sådan håndterer du produkter med beskyttelsesfilm

- Før du samler produktet, skal du fjerne beskyttelsesfilmen fra kanter og andre overflader, der kan vanskeliggøre monterng.
- Lad beskyttelsesfilmen sidde de øvrige steder, så du ikke beskadiger produktet under monterng. Fjern al beskyttelsesfilm efter monterng.
- BEMÆRK!** Umiddelbart efter at du har fjernet beskyttelsesfilmen, kan overfladen være særligt modtagelig over for ridser.
- For at gøre overfladen stærkere, skal du tørre den af med en blød klud og en mild sæbeopløsning (maks. 1%, ingen alkohol eller slipemidler).

Íslenska

Þrífðu með mjúkum rökum klút og mildu hreinsiefni án svarfefna eða sápu, ef nauðsyn krefur. Þurrkaðu með hreinum klút.

Meðhöndlun vara með varnarfilmu

- Fjarlægðu filmuna af brúnum og öðru yfirborði sem gæti haft áhrif á samsetninguna.
- Skildu þá filmu sem eftir er til að koma í veg fyrir skemmdir meðan þú setur saman vöruna. Eftir samsetningu skal fjarlægja alla varnarfilmu.
- Athugaðu – yfirborð gæti verið mjög viðkvæmt fyrir rispum rétt eftir að filman hefur verið fjarlægð.
- Þurrkaðu yfirborðið með mildri sápulausn (háms. 1%, án alkóhóls eða svarfefna) til að auka þol yfirborðsins gegn rispum.

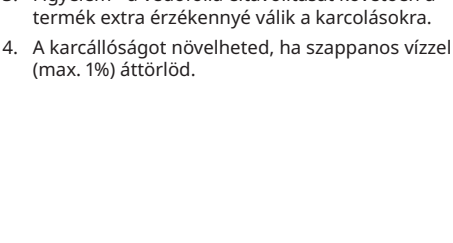
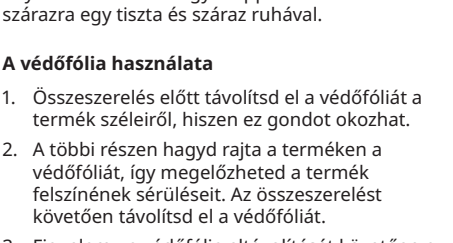
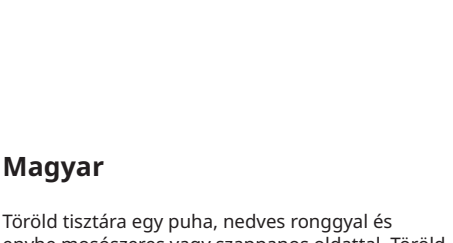

Norsk

Tørk av med en myk klut fuktet med vann og litt mildt oppvaskemiddel eller såpe om nødvendig. Tørk over med en ren klut.

Slik håndterer du produkter med beskyttelsesfilm

- Før monterng må all beskyttelsesfilm fjernes fra kanter og andre flater som kan komme i veien under monterng.
- Behold den øvrige beskyttelsesfilmen for å unngå å skade produktet under monterng. Etter monterng, all beskyttelsesfilm fjernes.
- Merk – flatene kan være ekstra mottagelige for skraper umiddelbart etter at beskyttelsesfilmen er fjernet.
- For å styrke motstanden mot riper ytterligere, kan overflaten tørkes over med mildt såpevann (maks 1 %, uten alkohol eller slipemiddel).

Suomi

Pyyhitään pehmeällä, veteen kostutetulla liinalla. Tarvittaessa voidaan käyttää mietoaa puhdistusainetta, joka ei sisällä hankaavia ainesosia. Kuivataan puhtaalla liinalla.

Suojakalvillisten tuotteiden käsittely

- Poista ennen kokoamisen aloittamista suojakalvo tuotteen reunoista ja muista pinnoista, joissa se voi häiritä kokoamista.
- Jätä loput suojakalvot paikalleen vaurioiden välttämiseksi kokoamisen aikana. Poista loput suojakalvot, kun kokoaminen on suoritettu.
- Huomioi, että pinnat voivat olla erityisen herkkiä naarmuille heti suojakalvon poistamisen jälkeen.
- Naarmunkeston parantamiseksi pyyhi pinnat miedolla saippualluoksella (enintään 1 %, ei alkoholia tai hankaavia aineita).

Svenska

Rengör med mjuk trasa fuktad i vatten och ev. rengöringsmedel utan slipmedel eller tvålösning. Eftertorka med torr trasa.

Så hanterar du dina produkter med skyddsfilm

- Innan monterng, ta bort skyddsfilm från kanter och andra ytor som kan störa monteringen.
- Låt resterande skyddsfilm sitta kvar för att undvika skador under monteringen. Efter monterng, ta bort all skyddsfilm.
- Obs – ytorna kan vara extra känsliga för repor direkt efter att skyddsfilmen tagits bort.
- För att förbättra tåligheten ytterligare, torka av ytorna med mild tvålösning (max 1%, ingen alkohol eller slipmedel).

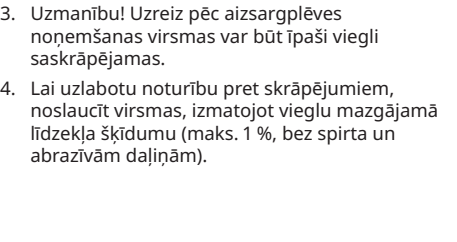
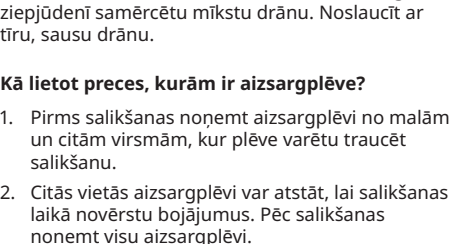
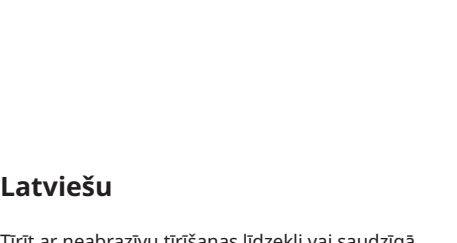

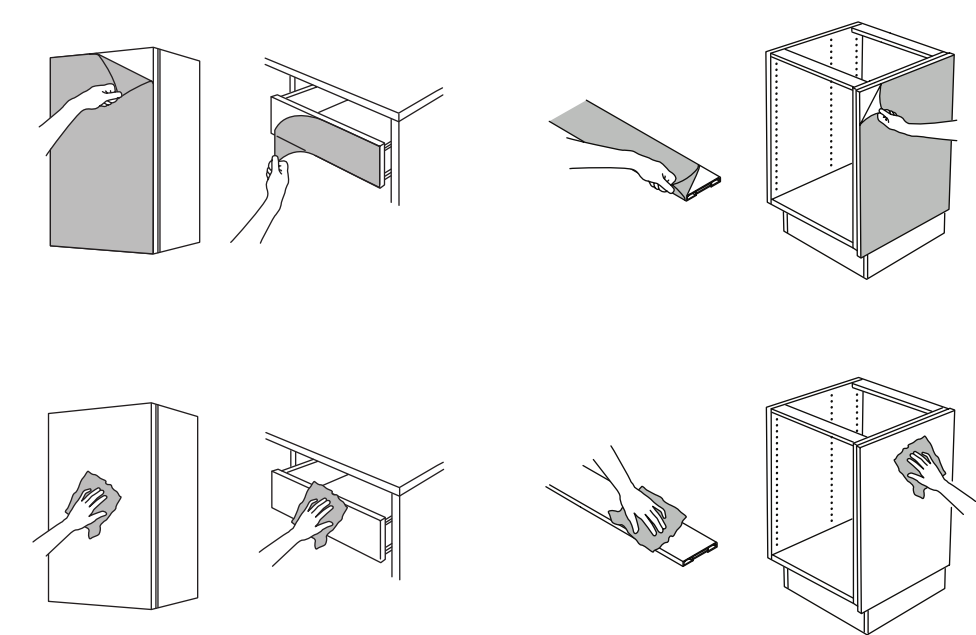

Русский

Протирать мягкой тканью, смоченной в воде с добавлением при необходимости мягкого неабразивного моющего средства или мыла. Затем вытирать чистой тканью.

Как обращаться с товарами с защитной пленкой

- Перед сборкой удалите защитную пленку с кромок и других поверхностей, где она может помешать сборке.
- Не удаляйте защитную пленку с других поверхностей, чтобы избежать повреждений при сборке. После сборки удалите всю защитную пленку.
- Внимание! Поверхности сразу после удаления защитной пленки могут быть очень чувствительны к царапинам .
- Для повышения устойчивости к царапинам протрите поверхности тканью, смоченной в слабом мыльном растворе (не более 1%, без спирта и абразивов).



한국어

부드러운 천을 물에 적신 뒤 비마모성 주방세제나 비누를 묻혀 닦아주세요. 깨끗한 천으로 물기를 닦아 마무리하세요.

보호 필름을 이용한 제품 취급

- 조립하기 전에 원활한 조립을 위해 모서리와 표면에 붙어 있는 보호 필름을 제거해 주세요.
- 다른 보호 필름은 조립 중 손상을 방지하기 위해 남겨두세요. 조립 후 모든 보호 필름을 제거하세요.
- 주의 - 보호 필름을 제거한 직후 표면이 긁힘에 매우 민감할 수 있습니다.
- 긁힘을 방지하기 위해 부드러운 비누 용액으로 표면을 닦아주세요. (최대 1%, 알코올이나 연마제가 없는 성분).

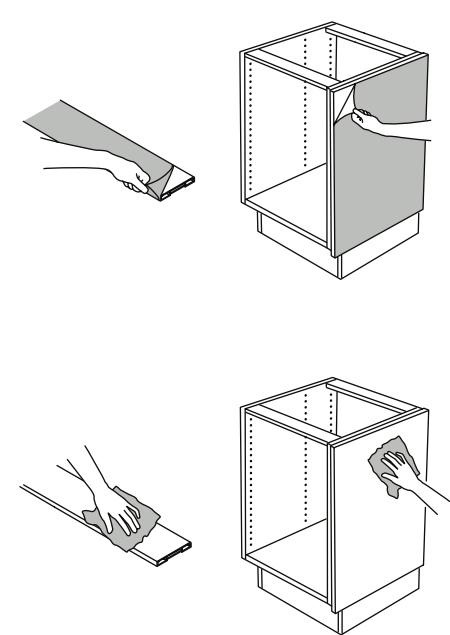

Româna

Curăța cu o cârpă înmuiată în apă și detergent delicat, neabraziv, sau săpun, dacă este necesar. Șterge cu o cârpă uscată.

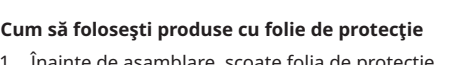

Cum să folosești produse cu folie de protecție

- Înainte de asamblare, scoate folia de protecție de pe margini și alte suprafețe care pot interfera cu asamblarea.
- Lasă restul foliei de protecție pentru a evita deteriorarea în timpul asamblării. După asamblare, scoate toată folia de protecție.
- Notă - suprafețele pot fi foarte sensibile la zgârieturi imediat după eliminarea foliei de protecție.
- Pentru a îmbunătăți rezistența la zgârieturi, șterge suprafețele cu o soluție de detergent delicat (max. 1%, fără alcool sau substanțe abrazive).



Srpski

Čisti mekom krpom nakvašenom vodom i blagom neabrazivnom tečnošću za sude ili sapunom, po potrebi. Osuši čistom krpom.

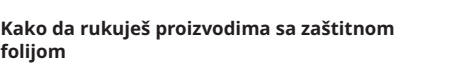

Kako da rukuješ proizvodima sa zaštitnom folijom

- Pre sastavljanja, ukloni foliju s ivica i drugih površina koje mogu uticati na sastavljanje.
- Ostavi preostalu zaštitnu foliju da izbegneš oštećenja tokom sastavljanja. Po sastavljanju, ukloni zaštitnu foliju.
- Napomena — površine mogu biti posebno osetljive na ogrebotine neposredno posle uklanjanja zaštitne folije.
- Da dodatno poboljšaš otpornost na ogrebotine, prebriši površine blagim rastvorom sapuna (maks. 1%, bez alkohola i abraziva).

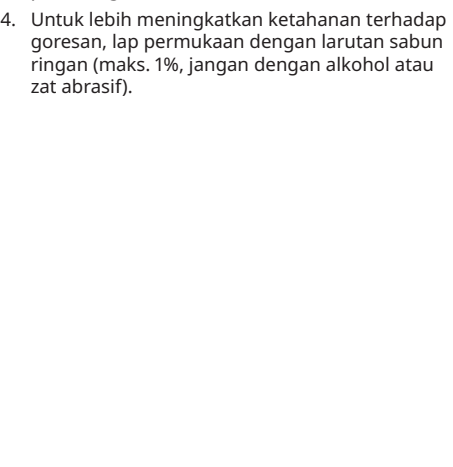

Slovensky

V prípade potreby utrite mäkkou handričkou namočenou vo vode a jemným neabrazívnym čistiacim prostriedkom na umývanie riadu alebo mydlom. Utrite do sucha čistou handričkou



Ako zaobchádzať s výrobkami s ochrannou fóliou

- Pred montážou odstráňte ochranný film z hrán a iných povrchov, ktoré by mohli byť montážou prekryté.
- Zostávajúcu ochrannú fóliu ponechajte, aby sa pri montáži výrobok nepoškodil. Po montáži zvyšok ochrannej fólie odstráňte.
- Pozor, povrchy môžu byť okamžite po odstránení ochrannej fólie mimoriadne citlivé na poškriabanie.
- Aby ste zlepšili ich odolnosť proti poškriabaniu, utrite povrchy jemným mydlovým roztokom (max. 1%, bez alkoholu alebo drsných čističiek).



Slovenščina

Očisti z mehko krpo, navlaženo z vodo, po potrebi lahko tudi z nežnim neabrazivnim čistilnim sredstvom. Obriši do suhega s čisto krpo.

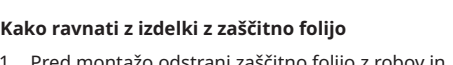

Kako ravnati z izdelki z zaščitno folijo

- Pred montažo odstrani zaščitno folijo z robov in drugih površin, kjer lahko ta ovira montažo.
- Na preostalih mestih ne odstrani zaščitne folije, da se površina med montažo ne poškoduje.
- Pomni – takoj po odstranitvi folije je površina posebno občutljiva na praske.
- Za boljšo odpornost proti praskam površine prebriši z mehko krpo, navlaženo z blago milnico (največ 1% raztopino brez alkohola ali abrazivnih sredstev).

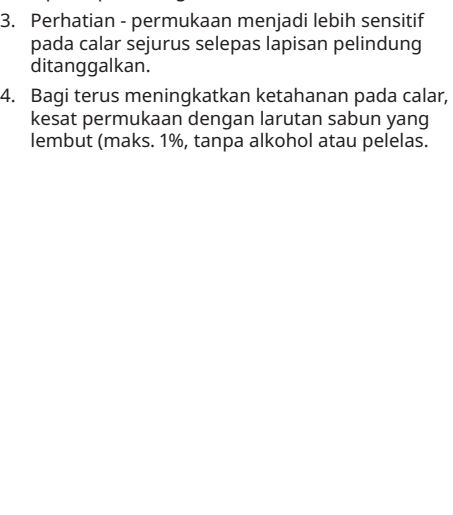
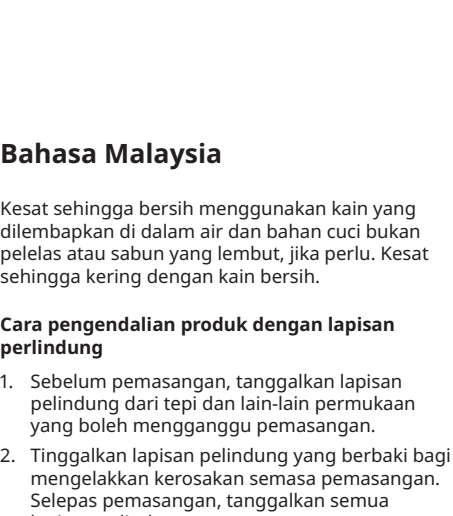

Български

Ако е необходимо, почистете с кърпа навлажнена с вода и мек неабразивен препарат или сапун. После подсушете с чиста кърпа.



Работа с продукти покрити с предпазно фолио

- Преди да започнете сглобяването премахнете предпазното фолио от ъглите и от други повърхност, ако пречат на сглобяването.
- Оставете останалото предпазно фолио с цел защита от щети по време на сглобяването. Премахнете изцяло предпазното фолио след като сте приключили със сглобяването.
- Забележка - след като премахнете предпазното фолио някои повърхности могат да бъдат по-уязвими на надраскване.
- За да направите артикула по-устойчив на надраскване, избършете повърхностите с мек сапунен разтвор (макс. 1%, без алкохол или абразивни елементи).



Türkçe

Suyla nemlendirilmis yumusak bir bez ve gerekirse hafif aşındırıcı olmayan bir deterjan veya sabunla silin. Temiz bir bezle kurulayın.

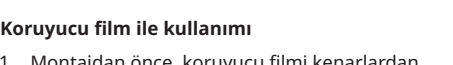

Koruyucu film ile kullanımı

- Montajdan önce, koruyucu filmi kenarlardan ve montaj engelleyebilecek diğer yüzeylerden çıkarın.
- Montaj sırasında hasar görmemesi için kalan koruyucu filmi bırakın. Montajdan sonra, tüm koruyucu filmi çıkarın.
- Not - koruyucu filmi çıkardıktan hemen sonra yüzeyler çiziklere karşı aşırı duyarlı olabilir.
- Çizilmelere karşı direnci arttırmak için, yüzeyleri yumuşak bir sabun çözeltisiyle silin (en fazla %1, alkol veya aşındırıcı madde içermemelidir).



Hrvatski

Očistiti krpom natopljenom u blagi deterđzent za pranje ili sapun, po potrebi. Osušiti čistom krpom.

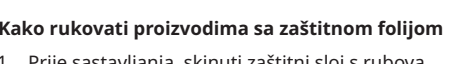

Kako rukovati proizvodima sa zaštitnom folijom

- Prije sastavljanja, skinuti zaštitni sloj s rubova ili ostalih površina koje mogu smetati pri sastavljanju.
- Ostaviti preostalu foliju radi izbjegavanja oštećenja nastalih tijekom sastavljanja. Nakon sastavljanja, skinuti svu zaštitnu foliju.
- Napomena – police mogu biti dodatno osjetljive na ogrebotine odmah po skidanju zašitnog sloja.
- Za povećavanje otpornosti na ogrebotine, prebriši površine blagom sapunskom otopinom (maks. 1 %, bez alkohola ili abraziva).



中文

用柔軟的抹布蘸水或不含磨劑的中性清潔劑或肥皂擦拭干淨。用干淨布塊擦干。

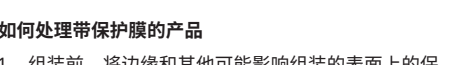

如何处理带保护膜的产品

- 组裝前，將邊緣和其他可能影响組裝的表面上的保護膜移除。
- 留下剩餘的保護膜，避免产品在組裝過程中受損。組裝完成后，移除所有保護膜。
- 注意：移除保護膜后，产品表面可能会更容易遭受刮擦。
- 为进一步防止刮擦，可用温和皂液擦拭表面（皂液浓度最高为1%，不含酒精或研磨剂）。

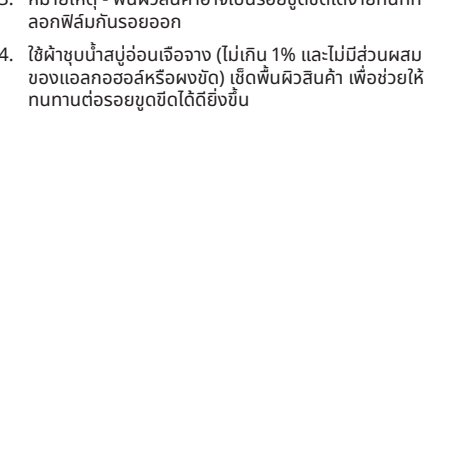
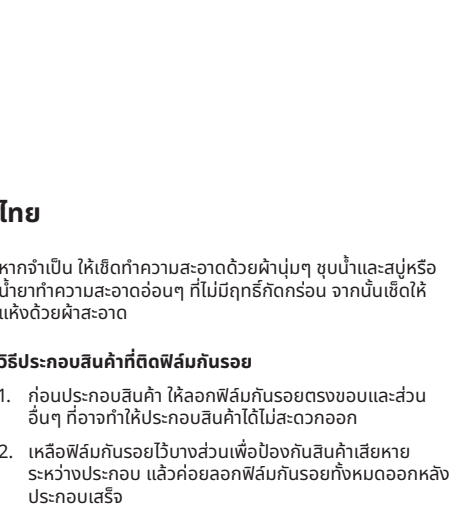

Ελληνικά

Καθαρίστε με ένα μαλακό πανί μουσκεμένο σε νερό και ήπιο, μη διαβρωτικό απορρυπαντικό ή σαπούνι, αν είναι απαραίτητο. Σκουπίστε με ένα καθαρό και στεγνό πανί.



Χρήση προϊόντων με την προστατευτική μεμβράνη

- Πριν την συναρμολόγηση, αφαιρέστε την προστατευτική μεμβράνη από τις άκρες και από άλλες επιφάνειες που μπορεί να παρεμβαίνει στην συναρμολόγηση.
- Αφίρηστε την προστατευτική μεμβράνη που υπολείπεται για να προστατεύσετε την επιφάνεια κατά τη διάρκεια της συναρμολόγησης. Μετά την συναρμολόγηση αφαιρέστε όλη την μεμβράνη.
- Σημείωση-οι επιφάνειες μπορεί να είναι πολύ ευαίσθητες στις γρατσουνιές αμέσως μετά την αφαίρεση της μεμβράνης.
- Για να βελτιώσετε περισσότερο την αντοχή στις γρατσουνιές, καθαρίστε τις επιφάνειες με ένα ήπιο διάλυμα σαπουνιού (μέγ. 1%, χωρίς αλκοόλ ή διαλύτες).



繁體

用軟布沾水、不含研磨成分的溫和清潔劑擦拭乾淨，再用乾淨的布擦乾。

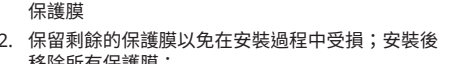

如何在產品應用保護膜

- 安裝前，請先移除邊緣及其他表面上會影響組裝的保護膜

- 保留剩餘的保護膜以免在安裝過程中受損；安裝後移除所有保護膜；

- 注意–移除保護膜後表面很容易被刮花

- 若要加強防刮能力，可用溫和的皂水(最多含1%或不含酒精或研磨劑)擦拭表面

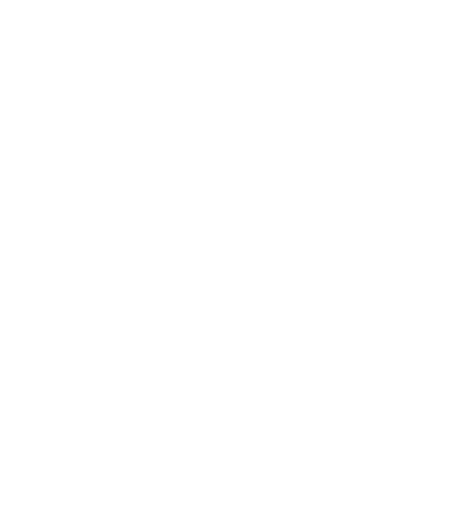

Tiếng Việt

Lau sạch bằng khăn mềm thấm nước và dung dịch tẩy rửa nhẹ như xà phòng hoặc nước rửa chén không ăn mòn, nếu cần. Lau khô bằng khăn sạch.

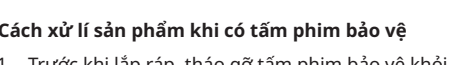

Cách xử lý sản phẩm khi có tấm phim bảo vệ

- Trước khi lắp ráp, tháo gỡ tấm phim bảo vệ khỏi các cạnh hoặc những khu vực có thể gây cản trở trong quá trình lắp ráp.

- Để phần còn lại của lớp phim bảo vệ để tránh bị hư hỏng trong quá trình lắp ráp. Sau khi lắp ráp, tháo gỡ tất cả tấm phim bảo vệ.

- Lưu ý - sau khi gỡ tấm phim bảo vệ, bề mặt sẽ dễ bị trầy xước.

- Để tăng độ bền bề mặt, lau bề mặt bằng dung dịch xà phòng dịu nhẹ (tối đa 1%, không cồn hoặc không chất ăn mòn).