

# MATÄLSKARE MATTRADITION

GB



Design and Quality  
IKEA of Sweden





Please refer to the last page of this manual for the full list of IKEA appointed Authorized Service Centre and relative national phone numbers.

## ENGLISH

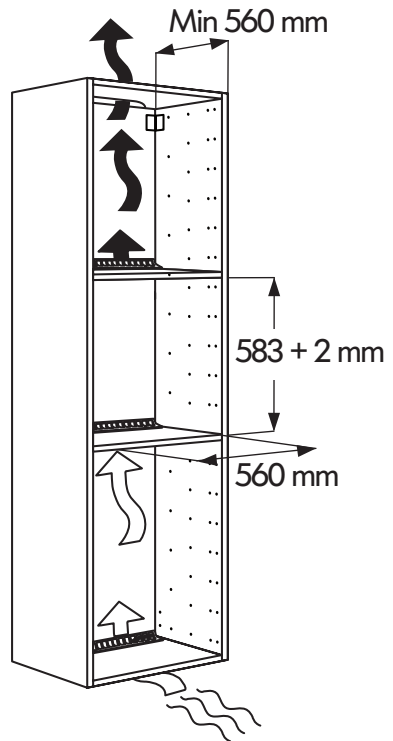
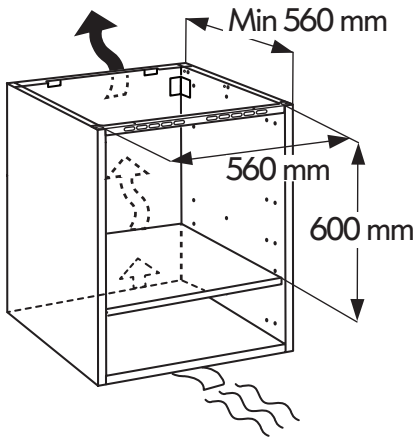

## Table of contents

Safety Information	5	What to do if ...	15
Product description	8	Technical data	16
Control panel	9	Installation	17
First use	9	Electrical connection	18
Daily use	9	Environmental concerns	18
Cooking tables	11	IKEA GUARANTEE	19
Cleaning and maintenance	13		

## Safety Information

Before using the appliance, read these safety instructions. Keep them nearby for future reference. These instructions and the appliance itself provide important safety warnings, to be observed at all times. The manufacturer declines any liability for failure to observe these safety instructions, for inappropriate use of the appliance or incorrect setting of controls.

### SAFETY WARNINGS

**⚠** Very young children (0-3 years) should be kept away from the appliance. Young children (3-8 years) should be kept away from the appliance unless continuously supervised. Children from 8 years old and above and persons with reduced physical, sensory or mental capabilities or lack of experience and knowledge can use this appliance only if they are supervised or have been given instructions on safe use and understand the hazards involved. Children must not play

with the appliance. Cleaning and user maintenance must not be carried out by children without supervision.

**⚠ WARNING!** The appliance and its accessible parts become hot during use. Care should be taken to avoid touching heating elements. Children less than 8 years old must be kept away unless continuously supervised.

**⚠ WARNING!** Never leave the appliance unattended during food drying. If the appliance is suitable for probe usage, only use a temperature probe recommended for this oven - risk of fire.

**⚠** Keep clothes or other flammable materials away from the appliance, until all the components have cooled down completely - risk of fire. Always be vigilant when cooking foods rich in fat, oil or when adding alcoholic beverages - risk of fire. Use oven gloves to remove pans and accessories. At the end of cooking, open the door with caution: allowing hot air or

steam to exit gradually before accessing the cavity - risk of burns. Do not obstruct hot air vents at the front of the oven - risk of fire.

⚠ Exercise caution when the oven door is in the open or down position, to avoid hitting the door.

### PERMITTED USE

⚠ **CAUTION:** the appliance is not intended to be operated by means of an external switching device, such as a timer, or separate remote controlled system.

⚠ This appliance is intended to be used in household and similar applications such as: staff kitchen areas in shops, offices and other working environments; farm houses; by clients in hotels, motels, bed & breakfast and other residential environments.

⚠ This appliance is not for professional use. Do not use the appliance outdoors.

No other use is permitted (e.g. heating rooms).

⚠ Do not store explosive or flammable substances (e.g. gasoline or aerosol cans) inside or near the appliance - risk of fire.

### INSTALLATION

⚠ The appliance must be handled and installed by two or

more persons - risk of injury. Use protective gloves to unpack and install - risk of cuts.

⚠ Installation, including water supply (if any) and electrical connections, and repairs must be carried out by a qualified technician. Do not repair or replace any part of the appliance unless specifically stated in the user manual.

Keep children away from the installation site. After unpacking the appliance, make sure that it has not been damaged during transport. In the event of problems, contact the dealer or your nearest After-sales Service. Once installed, packaging waste (plastic, styrofoam parts etc.) must be stored out of reach of children - risk of suffocation. The appliance must be disconnected from the power supply before any installation operation - risk of electrical shock. During installation, make sure the appliance does not damage the power cable - risk of fire or electrical shock. Only activate the appliance when the installation has been completed.

⚠ Carry out all cabinet cutting works before fitting the appliance in the furniture and remove all wood chips and sawdust.

Do not obstruct the minimum gap between the worktop and the

upper edge of the oven - risk of burn.

Do not remove the oven from its polystyrene foam base until the time of installation.

⚠ After installation, the bottom of the appliance must no longer be accessible - risk of burn.

⚠ Do not install the appliance behind a decorative door - risk of fire.

### **ELECTRICAL WARNINGS**

⚠ The rating plate is on the front edge of the oven (visible when the door is open).

⚠ It must be possible to disconnect the appliance from the power supply by unplugging it if plug is accessible, or by a multi-pole switch installed upstream of the socket and the appliance must be earthed, in conformity with national electrical safety standards.

⚠ Do not use extension leads, multiple sockets or adapters. The electrical components must not be accessible to the user after installation.

Do not use the appliance when you are wet or barefoot.

Do not operate this appliance if it has a damaged power cable or plug, if it is not working properly, or if it has been damaged or dropped.

⚠ If the supply cord is damaged, it must be replaced with an identical one by the manufacturer, its service agent or similarly qualified persons in order to avoid a hazard - risk of electrical shock.

⚠ In case of replacement of power cable, contact an authorized service center.

**Product description**

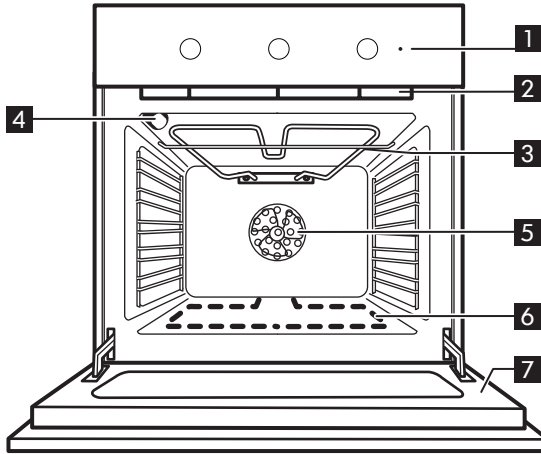

- 1** Control panel
- 2** Cooling fan (not visible)
- 3** Grill element
- 4** Oven lamp
- 5** Oven fan
- 6** Lower heating element (hidden)
- 7** Oven door

**Accessories**

Baking tray

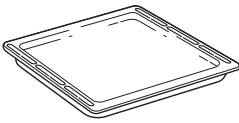

1x

Deep tray

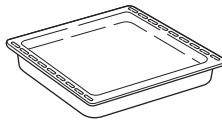

1x

Wire Shelf

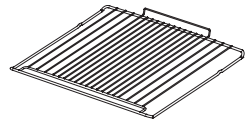

1x

Grill pan set

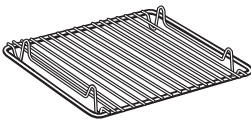

1x

**Inserting the wire shelf and other accessories**

Insert the wire shelf onto the level you require by holding it tilted slightly upwards and resting the raised rear side (pointing upwards) down first. Next, slide it horizontally along the shelf guide as far as possible.

The other accessories, such as the baking tray, are inserted horizontally by sliding them along the shelf guides.

If you want to buy an accessory, call the Authorized Service Centre.



Control panel

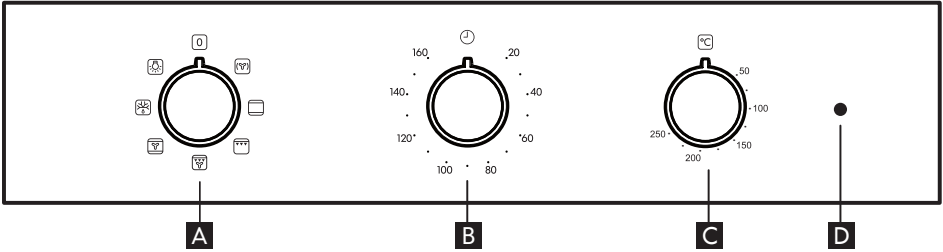

- A** Selection knob
- B** Time knob

- C** Thermostat knob
- D** Led thermostat/preheating

First use

Remove the accessories from the oven and heat it at 200° for about an hour to eliminate

the smell and fumes from the insulating materials and protective grease.

Daily use

1. Select a function

To select a function, turn the *selection knob* to the symbol for the function you require.

2. Turn on/off the oven

To switch on the oven turn the **A** Knob to the desired function, to switch off turn the **A** knob to position "0".

3. Preheating

Once the function has been activated, the LED thermostat will switch on signalling that the preheating process has begun.

At the end of this process, the LED thermostat switches off indicating that the oven has reached the set temperature: At this point, place the food inside and proceed with cooking.

**Please note:** Placing the food in the oven before preheating has finished may have an adverse effect on the final cooking result.

4. Setting the timer





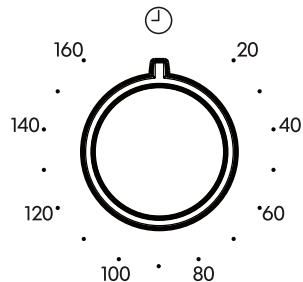

This option does not interrupt or activate cooking but allows you to use the minute minder both while a function is active and when the oven is off.

To activate the timer, turn the *timer knob* right round in an clockwise direction and then turn it back in the opposite direction to the desired duration: an acoustic signal will warn you when the count-down is finished.































## Oven functions table

The oven has 5 cooking levels. Count up from the lower level.









Function		Description of function
<b>0</b>	<b>OVEN OFF</b>	For switching off the oven.
	<b>FORCED AIR</b>	For cooking different foods that require the same cooking temperature on several shelves (maximum three) at the same time. This function can be used to cook different foods without odours being transferred from one food to another.
	<b>CONVENTIONAL (Top and Bottom Heat)</b>	For cooking any kind of dish on one shelf only. It is best to use the 2nd shelf.
	<b>GRILL</b>	For grilling steaks, kebabs and sausages, cooking vegetables au gratin or toasting bread. When grilling meat, we recommend using a drip tray to collect the cooking juices: position the pan on any of the levels below the wire shelf and add 200 ml of drinking water.
	<b>GRILLING WITH FAN</b>	For roasting large joints of meat (legs, roast beef, chicken). We recommend using a drip tray to collect the cooking juices: position the pan on any of the levels below the wire shelf and add 500 ml of drinking water.
	<b>CONVECTION BAKE</b>	For baking cakes with juicy fillings on a single shelf. This function can also be used for cooking on two shelves. Switch the position of the dishes to cook food more evenly.
	<b>DEFROST</b>	For defrosting food more quickly. Place the food in the center of the cavity, level 3
	<b>LIGHT</b>	For switching on the light in the compartment.

**Cooking tables**

Type of food	Function	Preheating	Level (from the bottom)	Temperature (°C)	Cooking time (min)
SWEETS, PASTRY, ETC					
<b>Leavened cakes</b>		X	2	150-170	30-90
		X	4-1	160-180	30-90
<b>Filled pies</b> (cheesecake, strudel, fruit pie)		X	2	160-200	35-90
		X	4-2	160-200	40-90
<b>Biscuits/tartlets</b>		X	2/3	160-180	15-40
		X	4-2/5-3-1	150-170	20-45
<b>Choux buns</b>		X	2	180-200	40-60
		X	4-2	170-190	35-50
<b>Meringues</b>		X	2	90	150-200
		X	4-2/5-3-1	90	140-200
<b>Bread/pizza/ focaccia</b>		X	1/2	220-250	10-40
		X	4-2	200-240	20-30
<b>Frozen pizza</b>		X	2	250	10-30
		X	4-2	230-250	10-30
<b>Savoury pies</b> (vegetable pie, quiche)		X	2	180-200	30-50
		X	4-2/5-3-1	180-200	30-60
<b>Vols-au-vent /Puff pastry crackers</b>		X	2	190-200	20-30
		X	4-2/5-3-1	180-190	20-40
<b>Lasagne, baked pasta, cannelloni, flans</b>		X	2	190-200	45-65
<b>Lasagna &amp; Meat</b>		X	4-2	200	50-100***
<b>Meat &amp; Potatoes</b>		X	4-1	190-200	45-100***
<b>Fish &amp; Vegetables</b>		X	4-1	180	30-50***
<b>Complete meal</b> Fruit tart (Level 5) / Lasagna (Level 3) / Meat (Level 1)		X	5-3-1	180-190	40-120***

Type of food	Function	Preheating	Level (from the bottom)	Temperature (°C)	Cooking time (min)
MEAT					
<b>Roast pork with crackling</b> 2 kg		X	2	180-190	110-150
<b>Lamb/Veal/Beef/Pork</b> 1Kg		X	2	190-200	80-120
<b>Chicken/Rabbit/Duck</b> 1Kg		X	2	200-230	50-100
<b>Turkey/Goose</b> 3Kg		X	2	180-200	150-200
FISH					
<b>Baked fish/en papillote</b> 0.5Kg (fillet, whole)		X	2	170-190	30-50
VEGETABLES					
<b>Stuffed vegetables</b> (tomatoes, courgettes, aubergines)		X	2	180-200	50-70

#### Cooking table with GRILL function

Type of food	Function	Preheating	Level (from the bottom)	Temperature (°C)	Cooking time (min)
<b>Toast</b>		5'	5	250	2-6
<b>Fish fillets/slices</b>		5'	4/3	250	15-30*
<b>Sausages/kebabs/spare ribs/hamburgers</b>		5'	5/4	250	15-30*
<b>Leg of lamb/knuckle</b>		–	3	200-220	60-90**
Vegetable gratin		–	3	200-220	30-60**
Roast potatoes		–	3	200-220	30-60**
<b>Roast chicken</b> 1-1.3 Kg		–	3	200-220	60-90**
<b>Roast beef rare</b> 1Kg		–	3	200-220	30-60**

**Note:** cooking temperatures and times are for guidance only.

\* Turn food halfway through cooking

\*\* Turn food two-thirds of the way through cooking (if necessary).

\*\*\* Estimated length of time: dishes can be removed from the oven at different times depending on personal preference.

**Cleaning and maintenance**

**CLEANING**

**⚠ WARNING!**

- Never use steam cleaning equipment.
- Only clean the oven when it is cool to the touch.
- Disconnect the appliance from the power supply.

**Oven exterior**

**i IMPORTANT:** do not use corrosive or abrasive detergents. If any of these products accidentally comes into contact with the appliance, clean immediately with a damp cloth.

- Clean the surfaces with a damp cloth. If it is very dirty, add a few drops of washing up detergent to the water. Finish off with a dry cloth.

**Oven interior**

**i IMPORTANT:** do not use abrasive sponges or metallic scrapers or scourers. Over time, these can ruin enamelled surfaces and the oven door glass.

- After every use, allow the oven to cool then clean it preferably while it is still warm in order to remove built-up dirt and stains caused by food residues (e.g. food with a high sugar content).
- Use proper oven detergents and follow the manufacturer's instructions to the letter.
- Clean the door glass with a suitable liquid detergent. The oven door can be removed to facilitate cleaning (see MAINTENANCE). Inner glass is smooth to facilitate cleaning.

**NOTE:** during prolonged cooking of foods with a high water content (e.g. pizza, vegetables, etc.) condensation may form on the inside of the door and around the seal. When the oven is cold, dry the inside of the door with a cloth or sponge.

**Accessories**

- Soak the accessories in water with washing up detergent immediately after use, handling them with oven gloves if still hot.
- Food residues can be easily removed using a brush or sponge.

**MAINTENANCE**

**⚠ WARNING!**

- Use safety gloves.
- Ensure the oven is cold before carrying out the following operations.
- Disconnect the oven from the power supply.

**To remove the shelf guides**

firmly grip the external part of the guide, and pull it towards you to extract the support and the two internal pins from the lodging.

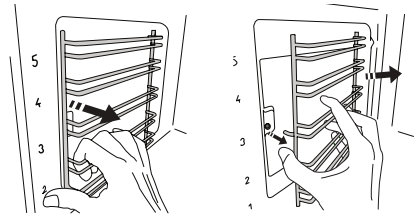

**To reposition the shelf guides**

position them near the cavity and initially insert the two pins into their lodgings. Next, position the external part near its lodging, insert the support, and firmly press towards the wall of the cavity to make sure the shelf guide is properly secured.

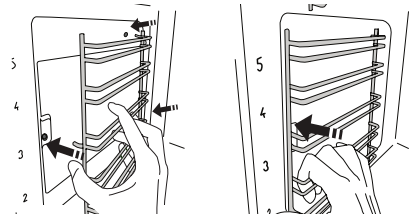

**To remove the door**

1. Open the door fully.
2. Lift the catches and push them forwards as far as they will go (Fig. 1).

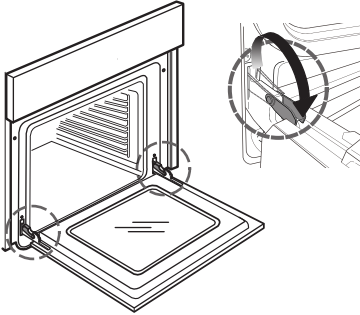

Fig. 1

3. Close the door as far as it will go (A), lift it up (B) and turn it (C) until it is released (D) (Fig. 2, 3, 4).

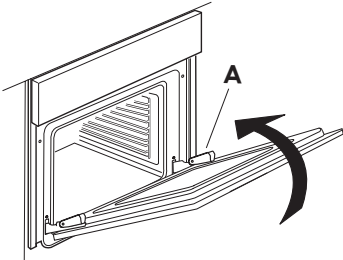

Fig. 2

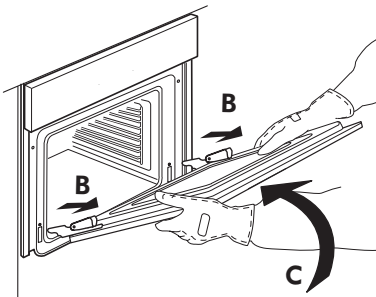

Fig. 3

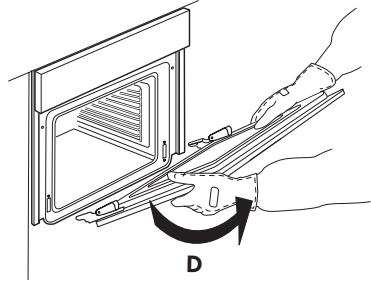

Fig. 4

**To refit the door**

1. Insert the hinges in their seats.
2. Open the door fully.
3. Lower the two catches.
4. Close the door

**Cleaning the glass**

1. After removing the door and resting it on a soft surface with the handle downwards, simultaneously press the two retaining clips and remove the upper edge of the door by pulling it towards you.

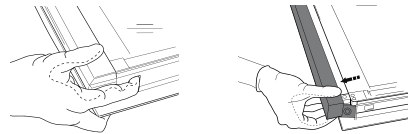

2. Lift and firmly hold the inner glass with both hands, remove it and place it on a soft surface before cleaning it. Do the same operation for the intermediate glass.
3. To reposition both the intermediate and the internal glass properly, be sure that the "R" can be seen in the left corner. First insert the long side of the glass indicated by "R" into the support seats, then lower it into position.

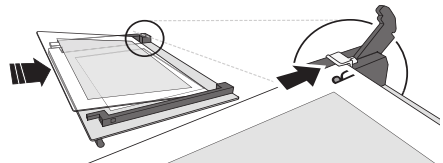

4. Refit the upper edge: A click will indicate correct positioning. Make sure the seal is secure before refitting the door.

**To replace the lamp**

1. Disconnect the oven from the power supply.

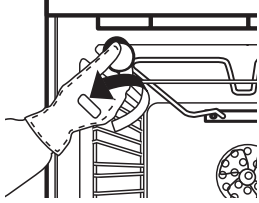

Fig. 5

2. Unscrew the lamp cover (Fig. 5), replace the lamp (see note for lamp type) and screw the lamp cover back on.
3. Reconnect the oven to the power supply.

**NOTE:**

- Only use 25W/230 V type G9, T300°C halogen lamps.
- The lamp used in the appliance is specifically designed for electrical appliances and it is not suitable for household room illumination (Commission Regulation (EC) No 244/2009).
- Lamps are available from IKEA Authorized Service Centre.

**What to do if ...**

Problem	Possible cause	Solution
The oven does not work.	No presence of mains electrical power.	Verify the presence of mains electrical power.
	The oven is not connected to the electrical supply.	Connect the oven to the power supply.
	The oven selector is turned to “☺”.	Turn the oven selector and select a cooking function.

**Before calling the Authorized Service Centre:**

1. See if you can solve the problem yourself with the help of the suggestions given in the “What to do if ...” table.
2. Switch the appliance off and back on again to see if the fault persists.  
If after the above checks the fault still occurs, contact IKEA Authorized Service Centre.

Always specify:

- a brief description of the fault;
- the type and exact model of the oven;
- the service number (number after the word Service on the rating plate), located on the right hand edge of the oven cavity (visible when the oven door is open);

**SERVICE** 0000 000 00000



- your full address;
- your telephone number.

If any repairs are required, please contact IKEA Authorized Service Centre (to guarantee that original spare parts will be used and repairs carried out correctly).

## Technical data

Type of product: Built-in Electrical Oven	
Model identification: MATÄLSKARE 103.687.81, MATTRADITION 203.687.85 MATTRADITION 504.118.72 MATTRADITION 804.118.75	
Number of cavities	1
Heat source	Electrical
Number of functions	6
Usable volume. Measured with any side grids and catalytic panels removed l	71
Area of the largest baking sheet cm <sup>2</sup>	1191
Energy Efficiency Class (Lowest Consumption)	A
Energy Efficiency Index	95,3
Energy consumption Conventional function (with a standard load and top + bottom heating) kWh/cycle	0,99
Energy consumption Fan Forced function (with a standard load and forced air heating) kWh/cycle	0,81
Top heating element W	2500
Bottom heating element W	1150
Grill heating element W	2500
Fan heating element W	1800
Cooling fan W	15
Oven lamp W	25
Oven Fan Wattage W	22
Total rating W	2750
Dimensions	
Width mm	595
Height mm	595
Depth mm	550
Mass of the appliance MATÄLSKARE stainless steel Kg MATTRADITION stainless steel Kg MATTRADITION White Kg MATTRADITION Black Kg	27 29 29 29



**Technical data**

The technical informations are situated in the rating plate inside the appliance.

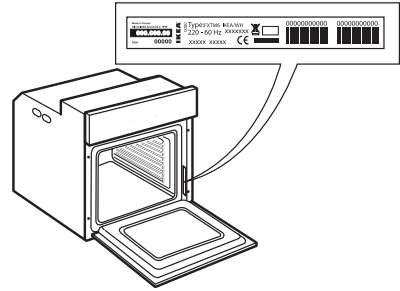

**Installation**

**Door lock device**

To open the door with the door lock device see Fig 1.

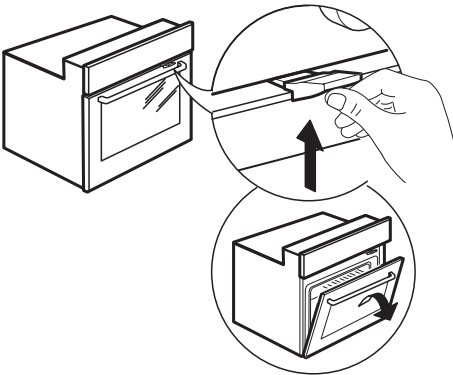

Fig. 1

The door safety device can be removed by following the sequence of images (see Fig. 2).

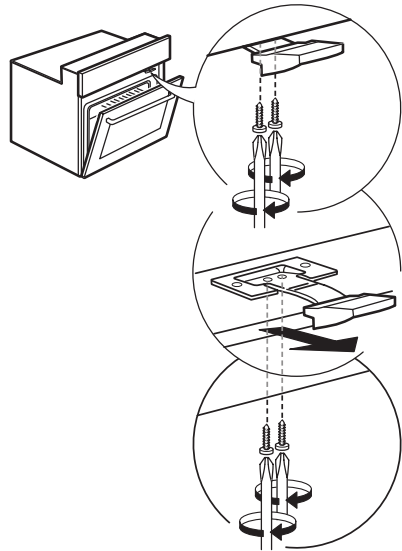

Fig. 2

## Electrical connection

Make sure the power voltage specified on the appliance rating plate is the same as the mains voltage. The rating plate is on the front edge of the oven (visible when the door is open).

Power cable replacement (type H05 V2V2 x 1,5 mm<sup>2</sup>) must be carried out by a qualified electrician. Contact IKEA Authorized Service Centre.

## Environmental concerns

**⚠ WARNING!** Ensure that the appliance is switched off and disconnected from the power supply before performing any maintenance operation - risk of electrical shock. Never use steam cleaning equipment.

**⚠** Do not use harsh abrasive cleaners or metal scrapers to clean the door glass since they can scratch the surface, which may result in shattering of the glass.

**⚠** Ensure the appliance is cooled down before any cleaning or maintenance. - risk of burn.

**⚠ WARNING!** Switch off the appliance before replacing the lamp - risk of electrical shock.

### DISPOSAL OF PACKAGING MATERIALS

The packaging material is 100% recyclable and is marked with the recycle symbol.  The various parts of the packaging must therefore be disposed of responsibly and in full compliance with local authority regulations governing waste disposal.

### SCRAPPING OF HOUSEHOLD APPLIANCES

This appliance is manufactured with recyclable or reusable materials. Dispose of

it in accordance with local waste disposal regulations. For further information on the treatment, recovery and recycling of household electrical appliances, contact your local authority, the collection service for household waste or the store where you purchased the appliance. This appliance is marked in compliance with European Directive 2012/19/EU, Waste Electrical and Electronic Equipment (WEEE). By ensuring this product is disposed of correctly, you will help prevent negative consequences for the environment and human health.



The symbol  on the product or on the accompanying documentation indicates that it should not be treated as domestic waste but must be taken to an appropriate collection center for the recycling of electrical and electronic equipment.

### ENERGY SAVING TIPS

Only preheat the oven if specified in the cooking table or your recipe. Use dark lacquered or enamelled baking trays as they absorb heat better. Food requiring prolonged cooking will continue to cook even once the oven is switched off.

### DECLARATION OF CONFORMITY

This appliance meets the Eco Design requirements of European Regulations n.65/2014 and 66/2014 in conformity to the European standard EN 60350-1.



## IKEA GUARANTEE

### How long is the IKEA guarantee valid?

This guarantee is valid for five years from the original date of purchase of your appliance at IKEA. The original sales receipt, is required as proof of purchase. If service work is carried out under guarantee, this will not extend the guarantee period for the appliance.

### Who will execute the service?

IKEA service provider will provide the service through its own service operations or authorized service partner network.

### What does this guarantee cover?

The guarantee covers faults of the appliance, which have been caused by faulty construction or material faults from the date of purchase from IKEA. This guarantee applies to domestic use only. The exceptions are specified under the headline "What is not covered under this guarantee?" Within the guarantee period, the costs to remedy the fault e.g. repairs, parts, labour and travel will be covered, provided that the appliance is accessible for repair without special expenditure. On these conditions the EU guidelines (Nr. 99/44/EG) and the respective local regulations are applicable. Replaced parts become the property of IKEA.

### What will IKEA do to correct the problem?

IKEA appointed Service Provider will examine the product and decide, at its sole discretion, if it is covered under this guarantee. If considered covered, IKEA Service Provider or its authorized service partner through its own service operations, will then, at its sole discretion, either repair the defective product or replace it with the same or a comparable product.

### What is not covered under this guarantee?

- Normal wear and tear.
- Deliberate or negligent damage, damage caused by failure to observe operating instructions, incorrect installation or by connection to the wrong voltage, damage caused by chemical or electrochemical reaction, rust, corrosion or water damage including but not

limited to damage caused by excessive lime in the water supply, damage caused by abnormal environmental conditions.

- Consumable parts including batteries and lamps.
- Non-functional and decorative parts which do not affect normal use of the appliance, including any scratches and possible color differences.
- Accidental damage caused by foreign objects or substances and cleaning or unblocking of filters, drainage systems or soap drawers.
- Damage to the following parts: ceramic glass, accessories, crockery and cutlery baskets, feed and drainage pipes, seals, lamps and lamp covers, screens, knobs, casings and parts of casings. Unless such damages can be proved to have been caused by production faults.
- Cases where no fault could be found during a technician's visit.
- Repairs not carried out by our appointed service providers and/or an authorized service contractual partner or where non-original parts have been used.
- Repairs caused by installation which is faulty or not according to specification.
- The use of the appliance in a non-domestic environment i.e. professional use.
- Transportation damages. If a customer transports the product to his home or another address, IKEA is not liable for any damage that may occur during transport. However, if IKEA delivers the product to the customer's delivery address, then damage to the product that occurs during this delivery will be covered by IKEA.
- Cost for carrying out the initial installation of the IKEA appliance.
- However, if an IKEA appointed Service Provider or its authorized service partner repairs or replaces the appliance under the terms of this guarantee, the appointed Service Provider or its authorized service partner will reinstall the repaired appliance or install the replacement, if necessary.

- This does not apply within Ireland, customer should contact the local IKEA dedicated after sales line or the appointed Service Provider for further information.  
**(just for GB)**

These restrictions do not apply to fault-free work carried out by a qualified specialist using our original parts in order to adapt the appliance to the technical safety specifications of another EU country.

### How country law applies

The IKEA guarantee gives you specific legal rights, which cover or exceed all the local legal demands. However these conditions do not limit in any way consumer rights described in the local legislation.

### Area of validity

For appliances which are purchased in one EU country and taken to another EU country, the services will be provided in the framework of the guarantee conditions normal in the new country.

An obligation to carry out services in the framework of the guarantee exists only if the appliance complies and is installed in accordance with:

- the technical specifications of the country in which the guarantee claim is made;
- the Assembly Instructions and User Manual Safety Information.

### The dedicated AFTER SALES for IKEA appliances

Please don't hesitate to contact IKEA appointed Authorized Service Centre to:

- make a service request under this guarantee;
- ask for clarifications on installation of the IKEA appliance in the dedicated IKEA kitchen furniture;
- ask for clarification on functions of IKEA appliances.

To ensure that we provide you with the best assistance, please read carefully the Assembly Instructions and/or the User Manual before contacting us.

### How to reach us if you need our service



Please refer to the last page of this manual for the full list of IKEA appointed Authorized Service Centre and relative national phone numbers.

- i** In order to provide you a quicker service, we recommend to use the specific phone numbers listed on this manual. Always refer to the numbers listed in the booklet of the specific appliance you need an assistance for. Please also always refer to the IKEA article number (8 digit code) and 12 digit service number placed on the rating plate of your appliance.

- i** **SAVE THE SALES RECEIPT!**  
It is your proof of purchase and required for the guarantee to apply. The sales receipt also reports the IKEA name and article number (8 digit code) for each of the appliances you have purchased.

### Do you need extra help?

For any additional questions not related to After Sales of your appliances please contact your nearest IKEA store call centre. We recommend you read the appliance documentation carefully before contacting us.



## BELGIË - BELGIQUE - BELGIEN

Telefoon/Numéro de téléphone/Telefon-Nummer:	026200311	
Tarif/Tarif/Tarif:	Lokaal tarief/Prix d'un appel local/Ortstarif	
Openingsstijd:	Maandag - Vrijdag	8.00 - 20.00
Heures d'ouverture:	Lundi - Vendredi	8.00 - 20.00
Öffnungszeiten:	Montag - Freitag	8.00 - 20.00

## БЪЛГАРИЯ

Телефонен номер:	02 4003536	
Тарифа:	Локална тарифа	
Работно време:	понеделник - петък	8.00 - 20.00

## ČESKÁ REPUBLIKA

Telefonní číslo:	225376400	
Sazba:	Míst ní sazba	
Pracovní doba:	Pondělí - Pátek	8.00 - 20.00

## DANMARK

Telefonnummer:	70150909	
Takst:	Lokal takst	
Åbningstid:	Mandag - fredag	9.00 - 20.00
	Lørdag (Åbent udvalgte søndage, se IKEA.dk)	9.00 - 18.00

## DEUTSCHLAND

Telefon-Nummer:	06929993602	
Tarif:	Ortstarif	
Öffnungszeiten:	Montag - Freitag	8.00 - 20.00

## ΕΛΛΑΔΑ

Τηλεφωνικός αριθμός:	2109696497	
Χρέωση:	Τοπική χρέωση	
Ώρες λειτουργίας:	Δευτέρα - Παρασκευή	8.00 - 20.00

## ESPAÑA

Teléfono:	913754126 (España Continental)	
Tarifa:	Tarifa local	
Horario:	Lunes - Viernes	8.00 - 20.00

## EESTI

<http://www.ikea.com>

## FRANCE

Numéro de téléphone:	0170480513	
Tarif:	Prix d'un appel local	
Heures d'ouverture:	Lundi - Vendredi	9.00 - 21.00

## HRVATSKA

Broj telefona:	0800 3636	
Tarifa:	Lokalna tarifa	
Radno vrijeme:	Ponedjeljak - Petak	8.00 - 20.00

## ÍSLAND

Símanúmer:	5852409	
Kostnaður við símtal:	Almennt mínútuverð	
Opnunartími:	Mánudaga - Föstudaga	9.00 - 17.00

## ITALIA

Telefono:	0238591334	
Tariffa:	Tariffa locale	
Orari d'apertura:	Lunedì - Venerdì	8.00 - 20.00

## LATVIJA

<http://www.ikea.com>

## LIETUVIŲ

Telefono numeris:	(0) 520 511 35	
Skambučių kaina:	Vietos mokėstis	
Darbo laikas:	Nuo pirmadienio iki penktadienio	8.00 - 20.00

## LUXEMBOURG

Numéro de téléphone:	035220882569	
Tarif:	Prix d'un appel local	
Heures d'ouverture:	Lundi - Vendredi	8.00 - 18.00

## MAGYARORSZÁG

Telefon szám:	(06-1)-3285308	
Tarifa:	Helyi tarifa	
Nyitvatartási idő:	Hétfőtől Péntekig	8.00 - 20.00

## NORGE

Telefon nummer:	23500112	
Takst:	Lokal takst	
Åpningstider:	Mandag - fredag	8.00 - 20.00

## NEDERLAND

Telefoon:	0900-235 45 32 en/of 0900 BEL IKEA	
	0031-50 316 8772 international	
Tarif:	Geen extra kosten. Alleen lokaal tarief.	
Openingsstijd:	Maandag t/m - Vrijdag	8.00 - 21.00
	Zaterdag	9.00 - 21.00
	Zondag / Feestdagen	10.00 - 18.00

## ÖSTERREICH

Telefon-Nummer:	013602771461	
Tarif:	Ortstarif	
Öffnungszeiten:	Montag - Freitag	8.00 - 20.00

## POLSKA

Numer telefonu:	225844203	
Stawka:	Koszt połączenia według taryfy operatora	
Godziny otwarcia:	Montag - Freitag	8.00 - 20.00

## PORTUGAL

Telefone:	213164011	
Tarifa:	Tarifa local	
Horário:	Segunda - Sexta	9.00 - 21.00

## ROMÂNIA

Număr de telefon:	021 2044888	
Tarif:	Tarif local	
Orar:	Luni - Vineri	8.00 - 20.00

## РОССИЯ

Телефонный номер:	84957059426	
Стоимость звонка:	Местная стоимость звонка	
Время работы:	Понедельник - Пятница	9.00 - 21.00
	(Московское время)	

## SCHWEIZ - SUISSE - SVIZZERA

Telefon-Nummer/Numéro de téléphone/Telefono:	0225675345	
Tarif/Tarif/Tariffa:	Ortstarif/Prix d'un appel local/Tariffa locale	
Öffnungszeiten:	Montag - Freitag	8.00 - 20.00
Heures d'ouverture:	Lundi - Vendredi	8.00 - 20.00
Orario d'apertura:	Lunedì - Venerdì	8.00 - 20.00

## SLOVENSKO

Telefónne číslo:	(02) 50102658	
Cena za hovor:	Cena za miestny hovor	
Pracovná doba:	Pondelok až piatok	8.00 - 20.00

## SLOVENIJA

<http://www.ikea.com>

## SRBIJA

Број телефона:	011 7 555 444	
стопа:	lokalna курс	
Радно време:	Понедељак - субота	9.00 - 20.00
	недеља	9.00 - 18.00

## SUOMI

Puhelinnumero:	0981710374	
Taxa:	Yksikköhinta	
Aukioloaika:	Maanantaista perjantaihin	8.00 - 20.00

## SVERIGE

Telefon nummer:	0775-700 500	
Taxa:	Lokal samtal	
Öppet tider:	Måndag - Fredag	8.30 - 20.00
	Lördag - Söndag	9.30 - 18.00

## UNITED KINGDOM - IRELAND

Phone number:	02076601517	
Rate:	Local rate	
Opening hours:	Monday - Friday	8.00am - 6.00pm
	Saturday	8.30am - 4.30pm
	Sunday	9.30am - 3.30pm







23256

AA-1951548-4