

MATÄLSKARE MATTRADITION

GB

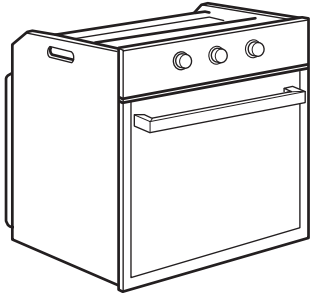

Design and Quality
IKEA of Sweden



1x

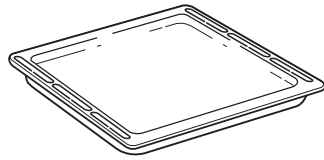

1x

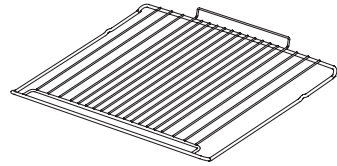

1x

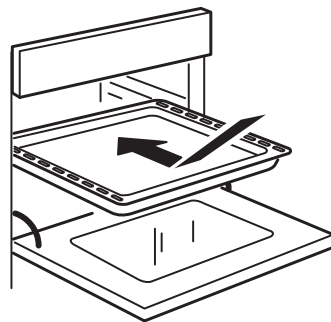
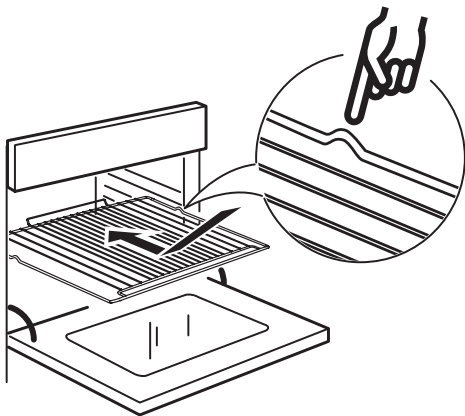
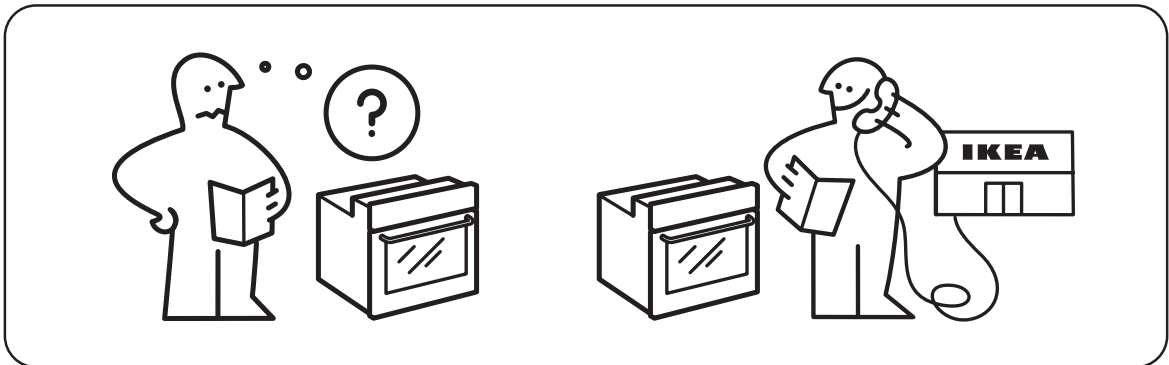

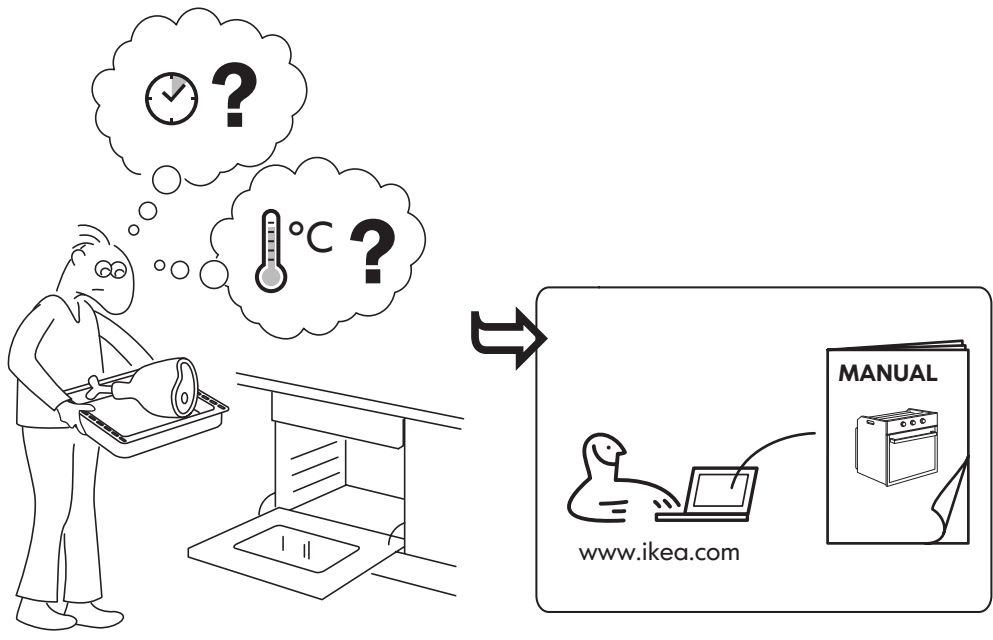
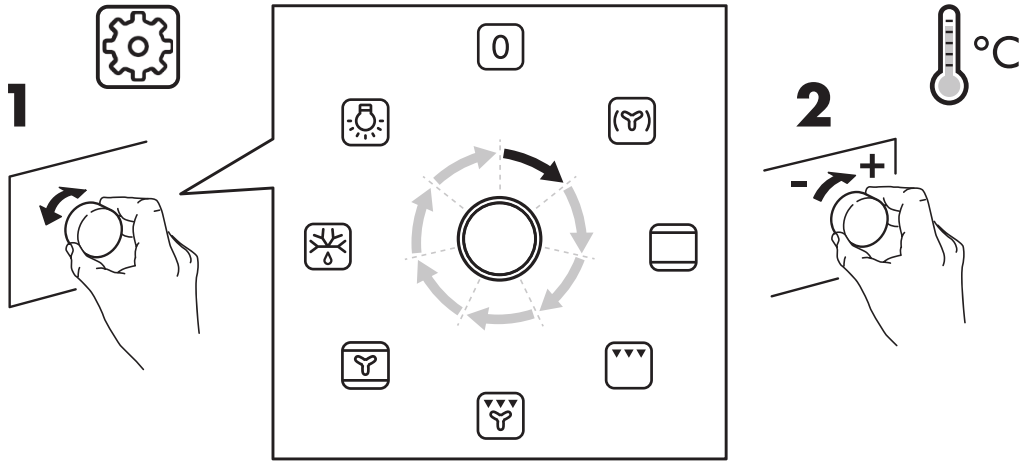

Product description

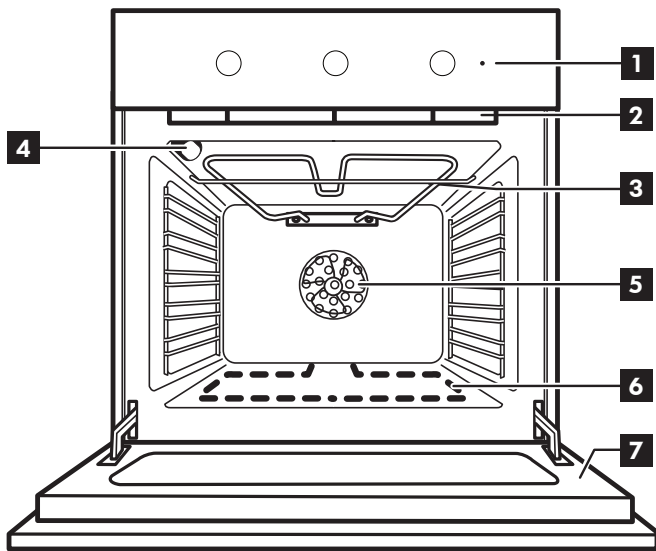

- 1** Control panel
- 2** Cooling fan (not visible)
- 3** Grill element
- 4** Oven lamp
- 5** Oven fan
- 6** Lower heating element (hidden)
- 7** Oven door

Inserting the wire shelf and other accessories

Insert the wire shelf onto the level you require by holding it tilted slightly upwards and resting the raised rear side (pointing upwards) down first. Next, slide it horizontally along the shelf guide as far as possible.

The other accessories, such as the baking tray, are inserted horizontally by sliding them along the shelf guides.



If you want to buy an accessory, call the Authorized Service Centre.

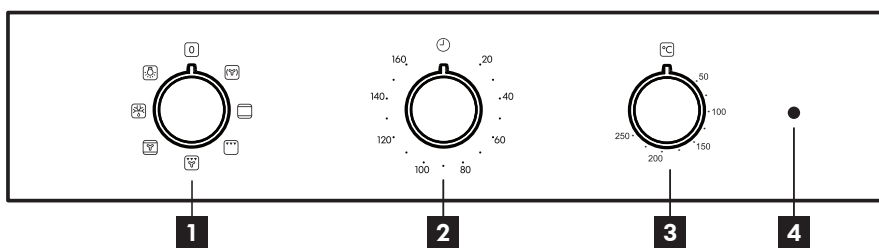



Control panel



- 1** Selection knob
- 2** Time knob
- 3** Thermostat knob
- 4** Led thermostat/preheating

Display / Function

-  **FORCED AIR**
For cooking different foods that require the same cooking temperature on several shelves (maximum three) at the same time.
-  **CONVENTIONAL (Top and Bottom Heat)**
For cooking any kind of dish on one shelf only.
-  **GRILL**
For grilling steaks, kebabs and sausages, cooking vegetables au gratin or toasting bread.

-  **GRILLING WITH FAN**
For roasting large joints of meat (legs, roast beef, chicken).
-  **CONVECTION BAKE**
For baking cakes with juicy fillings on a single shelf.
-  **DEFROST**
For defrosting food more quickly.
-  **LIGHT**

| | | | | | | |
|---------------------------|---|---------------|------------------|--------------------------|--|----------------------------|
| MATÅLSKARE | 103 687 81 | | 1 | | 71 | 29 |
| MATTRADITION | 203 687 85 504 118 72 804 118 75 | | 1 | | 71 | 27 |
| GB Manufacturer | Model | Built-in Oven | Number of cavity | Heat source : electrical | Usable volume (litres) Measured with any side grids and catalytic panels removed | Mass of the appliance (Kg) |

| | | | | | |
|---------------------------|--|-------------------------|--|---|---|
| MATÅLSKARE | 0,81 | 95,3 | A | 0,99 | 1200 |
| MATTRADITION | 0,81 | 95,3 | A | 0,99 | 1200 |
| GB Manufacturer | Fan Forced function (measured with any sliding shelves and catalytic panels removed) | Energy Efficiency Index | Energy Efficiency Class (Lowest Consumption) | Energy consumption (kWh/cycle) Conventional function (measured with any sliding shelves and catalytic panels removed) | Area of the largest baking sheet (cm ²) |

400011341062

