



Dansk

Tørres eventuelt af med en blød, fugtig klud tilsat et mildt, ikke-slibende opvaskemiddel eller sæbe. Tør efter med en ren, tør klud.

Sådan håndterer du produkter med beskyttelsesfilm

- Før du samler produktet, skal du fjerne beskyttelsesfilmen fra kanter og andre overflader, der kan vanskeliggøre monteringen.
- Lad beskyttelsesfilmen sidde de øvrige steder, så du ikke beskadiger produktet under monteringen. Fjern al beskyttelsesfilm efter monteringen.
- BEMÆRK!** Umiddelbart efter at du har fjernet beskyttelsesfilmen, kan overfladen være særligt modtagelig over for ridser.
- For at gøre overfladen stærkere, skal du tørre den af med en blød klud og en mild sæbeopløsning (maks. 1%, ingen alkohol eller slipemidler).

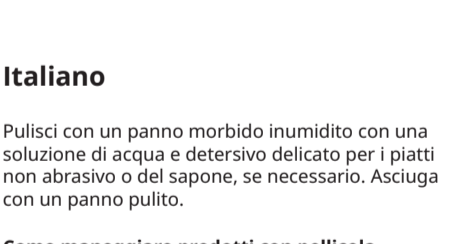

Come maneggiare prodotti con pellicola protettiva

- Prima del montaggio, togli la pellicola protettiva dai bordi e dalle altre superfici dove potrebbe interferire con il montaggio.
- Lascia la pellicola protettiva sulle parti rimanenti per evitare danni durante il montaggio. Una volta terminato il montaggio, puoi rimuovere tutta la pellicola protettiva.
- N.B. Subito dopo aver tolto la pellicola protettiva, la superficie è particolarmente sensibile ai graffi.
- Per migliorarne la resistenza ai graffi, lava la con una soluzione di acqua e sapone poco concentrata (max 1%). Non usare prodotti contenenti alcool o abrasivi.

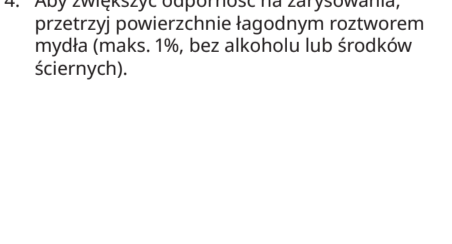
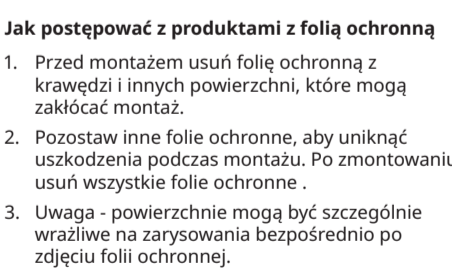
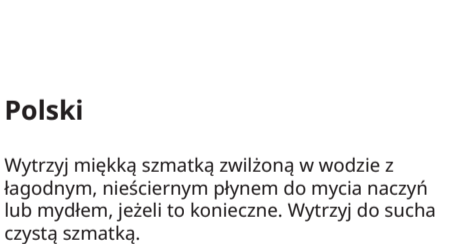
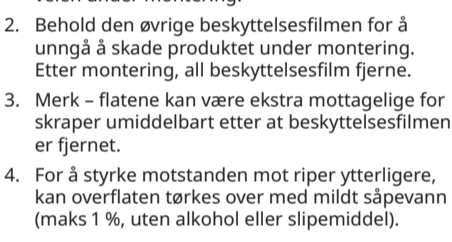
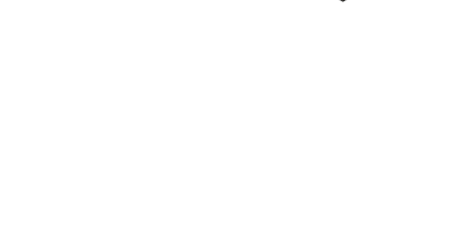
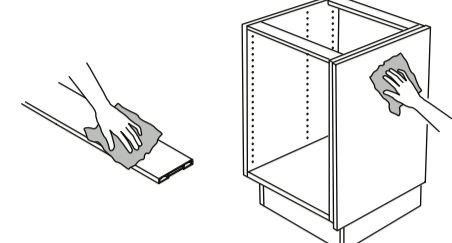
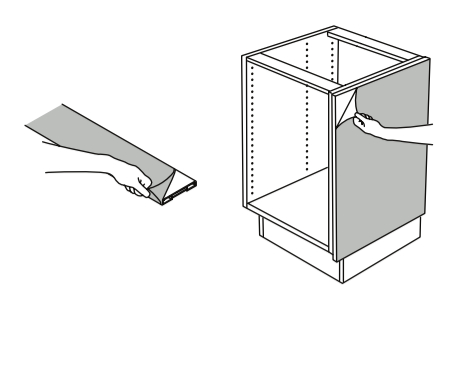
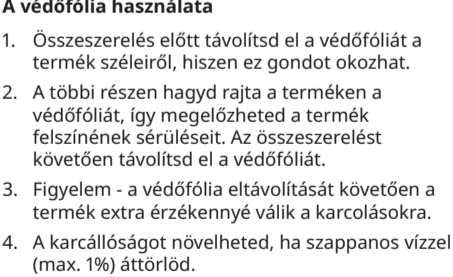
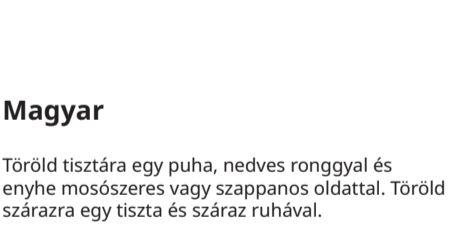
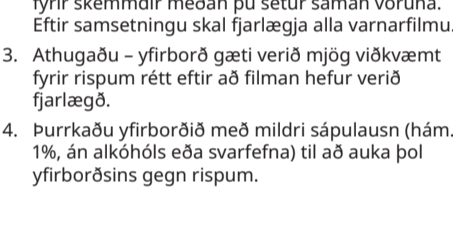
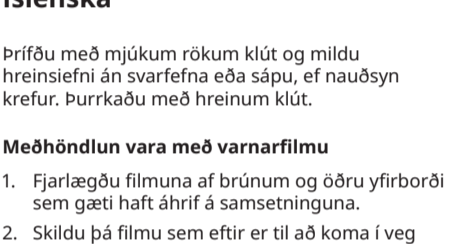
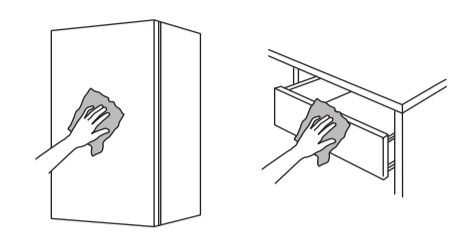
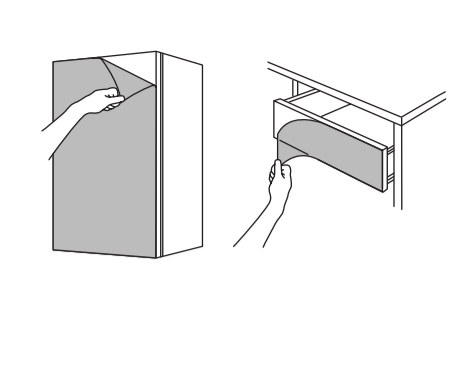

English

Wipe clean with a soft cloth dampened in water and a mild non-abrasive washing-up detergent or soap, if necessary. Wipe dry with a clean cloth.

How to handle your products with protective film

- Before assembly, remove protective film from edges and other surfaces which may interfere with assembly.
- Leave remaining protective film to avoid damage during assembly. After assembly, remove all protective film.
- Note – surfaces may be extra sensitive to scratches immediately after removing the protective film.
- To further improve resistance to scratches, wipe surfaces with a mild soap solution (max. 1%, no alcohol or abrasives).

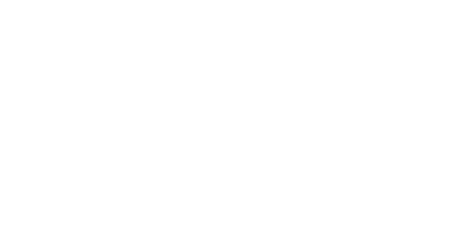
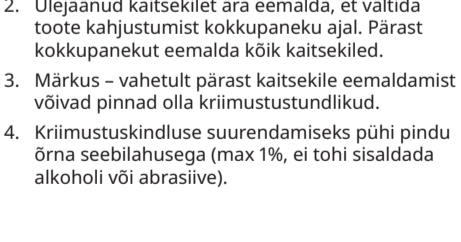
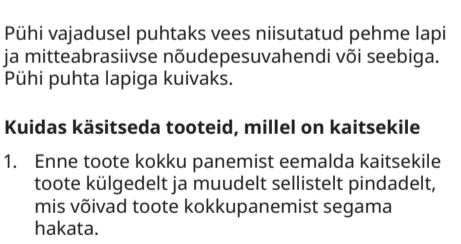
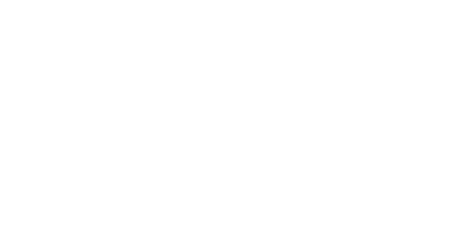
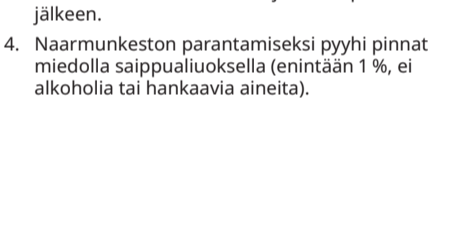
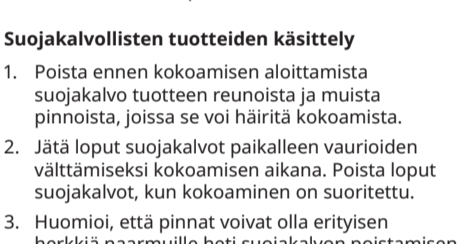
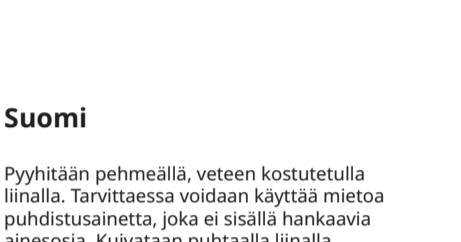

Deutsch

Mit einem in Wasser angefeuchteten weichen Tuch und, wenn nötig, mit schleifmittelfreiem Reinigungsmittel oder Seifenlösung säubern. Mit einem sauberen Tuch abtrocknen.

Behandlung von Produkten mit Schutzfolie

- Vor der Montage die Schutzfolie von der Kante und anderen Oberflächen entfernen, wo sie bei der Montage störend sein könnte.
- Die übrige Schutzfolie am Produkt belassen, um Schäden beim Montieren zu vermeiden. Die Schutzfolie nach der Montage komplett entfernen.
- Bitte beachten - direkt nach Entfernen der Schutzfolie kann die Oberfläche besonders empfindlich gegen Kratzer sein.
- Zur Erhöhung der Strapazierfähigkeit die Oberfläche mit einem weichen Tuch und einer milden Seifenlauge (max. 1%; keine alkohohaltigen Mittel oder Schleifmittel) abwischen.

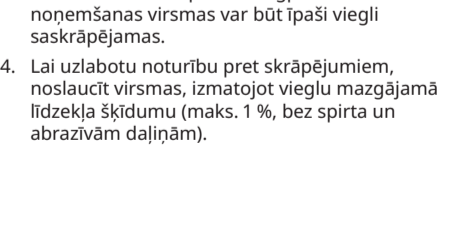
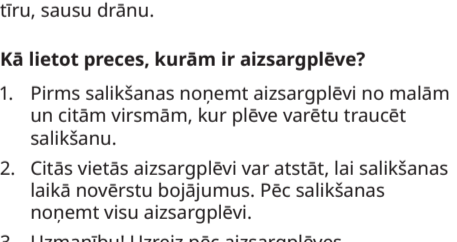
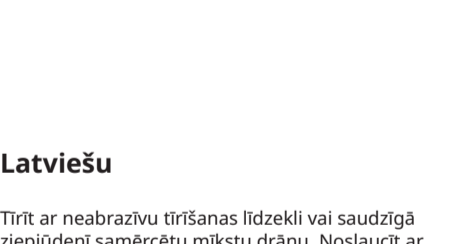
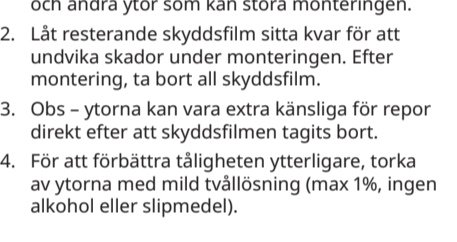
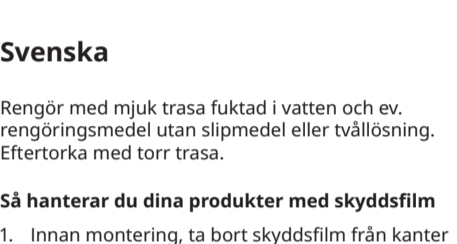

Français

Nettoyer à l'aide d'un chiffon doux imbibé d'eau et, si besoin, d'un détergent non abrasif ou de savon. Essuyer avec un chiffon propre.

Que faire du film protecteur sur les produits.

- Avant le montage, retirer le film de protection qui pourrait gêner, notamment au niveau des coins ou sur certaines surfaces.
- Laisser le film de de protection s'il ne gêne pas, afin d'éviter tout risque de dommages lors du montage. Après le montage, retirer tout le film protecteur.
- Attention : une fois le film retiré, la surface craint particulièrement les rayures.
- Pour renforcer la résistance à l'usure, nettoyer à l'aide d'un chiffon doux trempé dans de l'eau savonneuse (max. 1 % de détergent).

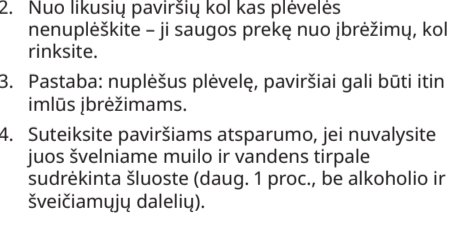
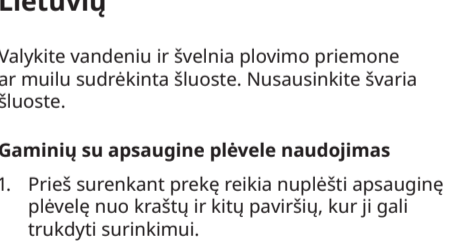
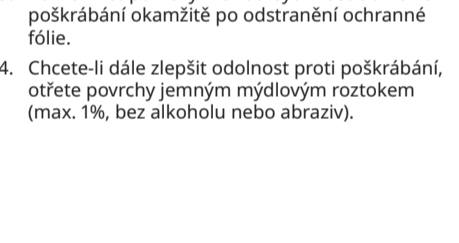
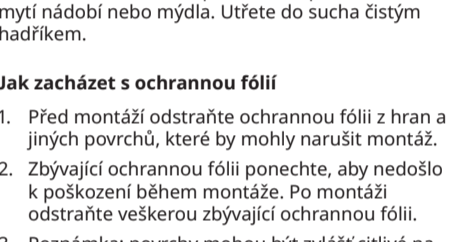
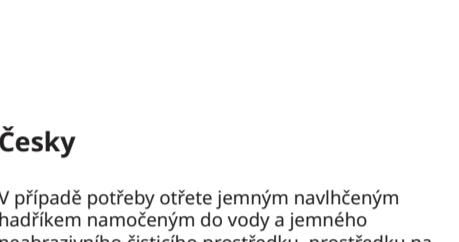

Nederlands

Schoonmaken met een vochtig doekje met water en evt. een schoonmaakmiddel zonder schuurmiddel, of een zeepoplossing. Nadrogen met een droge doek.

Omgaan met producten met beschermfolie

- Voor de montage: verwijder de beschermfolie van de randen en andere oppervlakken die de montage kunnen belemmeren.
- Laat de resterende beschermfolie zitten om beschadigingen tijdens de montage te voorkomen.
- Let op - oppervlakken kunnen meteen nadat de beschermfolie verwijderd is extra gevoelig zijn voor krassen.
- Om de slijtvastheid nog verder te verbeteren, de oppervlakken afnemen met een milde zeepoplossing (max. 1 %, geen alcohol of schuurmiddel).

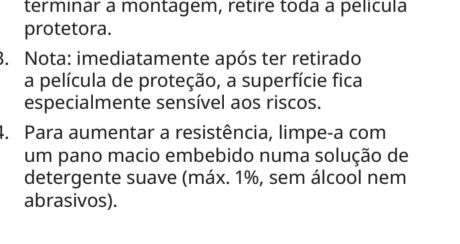
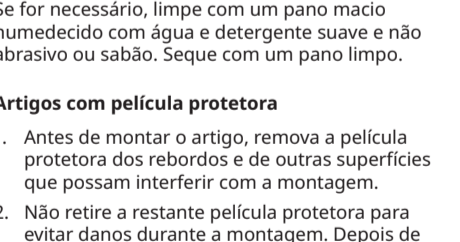
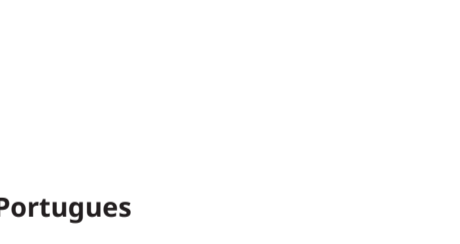
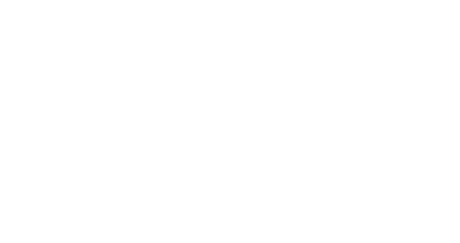
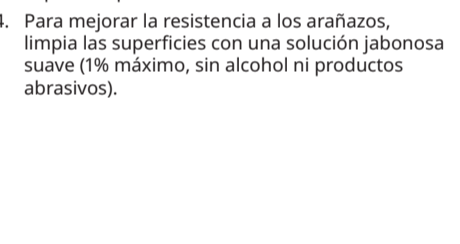
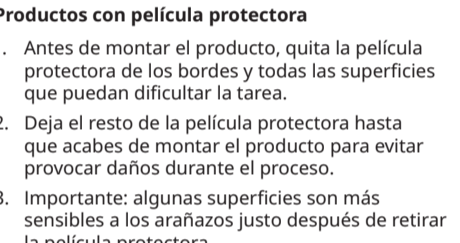
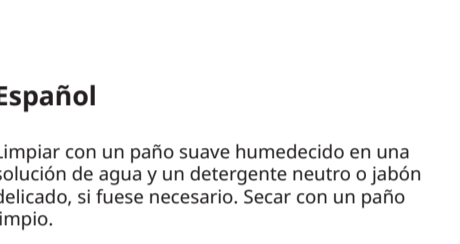

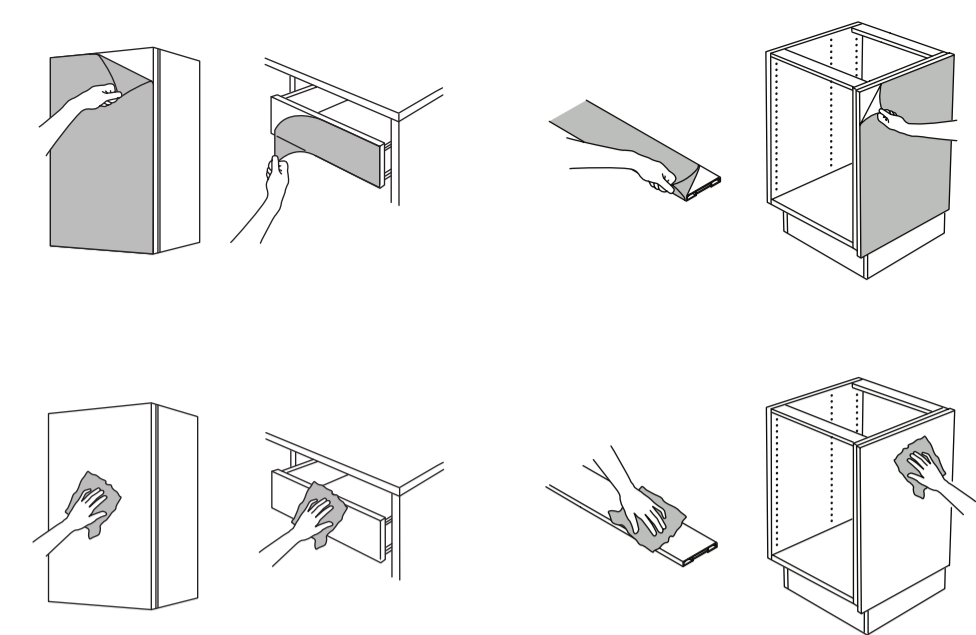

Русский

Протирать мягкой тканью, смоченной в воде с добавлением при необходимости мягкого неабразивного моющего средства или мыла. Затем вытирать чистой тканью.

Как обращаться с товарами с защитной пленкой

- Перед сборкой удалите защитную пленку с кромок и других поверхностей, где она может помешать сборке.
- Не удаляйте защитную пленку с других поверхностей, чтобы избежать повреждений при сборке. После сборки удалите всю защитную пленку.
- Внимание! Поверхности сразу после удаления защитной пленки могут быть очень чувствительны к царапинам .
- Для повышения устойчивости к царапинам протрите поверхности тканью, смоченной в слабом мыльном растворе (не более 1%, без спирта и абразивов).



한국어

부드러운 천을 물에 적신 뒤 비마모성 주방세제나 비누를 묻혀 닦아주세요. 깨끗한 천으로 물기를 닦아 마무리하세요.

보호 필름을 이용한 제품 취급

- 조립하기 전에 원활한 조립을 위해 모서리와 표면에 붙어 있는 보호 필름을 제거해 주세요.
- 다른 보호 필름은 조립 중 손상을 방지하기 위해 남겨주세요. 조립 후 모든 보호 필름을 제거하세요.
- 주의 - 보호 필름을 제거한 직후 표면이 긁힘에 매우 민감할 수 있습니다.
- 긁힘을 방지하기 위해 부드러운 비누 용액으로 표면을 닦아주세요. (최대 1%, 알코올이나 연마제가 없는 성분).

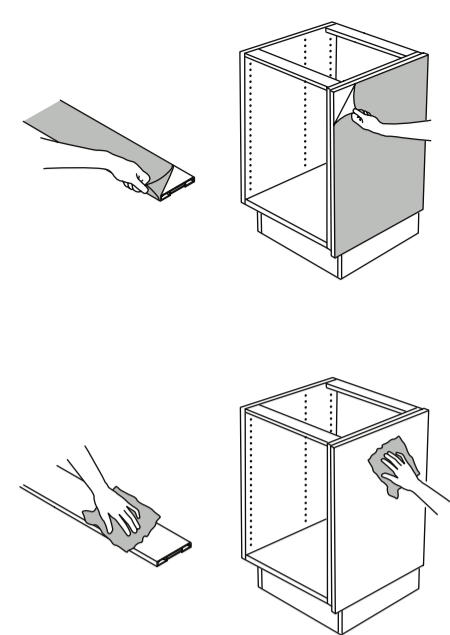

Româna

Curăța cu o cârpă înmuiată în apă și detergent delicat, neabraziv, sau săpun, dacă este necesar. Șterge cu o cârpă uscată.

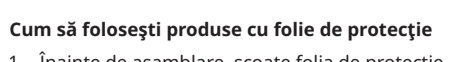

Cum să folosești produse cu folie de protecție

- Înainte de asamblare, scoate folia de protecție de pe margini și alte suprafețe care pot interfera cu asamblarea.
- Lasă restul foliei de protecție pentru a evita deteriorarea în timpul asamblării. După asamblare, scoate toată folia de protecție.
- Notă - suprafețele pot fi foarte sensibile la zgârieturi imediat după eliminarea foliei de protecție.
- Pentru a îmbunătăți rezistența la zgârieturi, șterge suprafețele cu o soluție de detergent delicat (max. 1%, fără alcool sau substanțe abrazive).



Srpski

Čisti mekom krpom nakvašenom vodom i blagom neabrazivnom tečnošću za sude ili sapunom, po potrebi. Osuši čistom krpom.

Kako da rukuješ proizvodima sa zaštitnom folijom

- Pre sastavljanja, ukloni foliju s ivica i drugih površina koje mogu uticati na sastavljanje.
- Ostavi preostalu zaštitnu foliju da izbegneš oštećenja tokom sastavljanja. Po sastavljanju, ukloni zaštitnu foliju.
- Napomena — površine mogu biti posebno osetljive na ogrebotine neposredno posle uklanjanja zaštitne folije.
- Da dodatno poboljšaš otpornost na ogrebotine, prebriši površine blagim rastvorom sapuna (maks. 1%, bez alkohola i abraziva).



Bahasa Indonesia

Bersihkan menggunakan kain lembut yang dibasahi air dan deterjen atau sabun berbusa sedikit non-abrasif, jika perlu. Lalu, lap hingga kering dengan kain bersih.

Cara melepas film pelindung pada produk Anda

- Sebelum merakit, lepaskan film pelindung dari tepi dan permukaan lain yang dapat mengganggu perakitan.
- Cabut film pelindung yang tersisa untuk menghindari kerusakan selama perakitan. Setelah perakitan, lepaskan semua film pelindung.
- Catatan - permukaan mungkin sangat sensitif terhadap goresan setelah melepas film pelindung.
- Untuk lebih meningkatkan ketahanan terhadap goresan, lap permukaan dengan larutan sabun ringan (maks. 1%, jangan dengan alkohol atau zat abrasif).

Slovensky

V prípade potreby utrite mäkkou handričkou namočenou vo vode a jemným neabrazívnym čistiacim prostriedkom na umývanie riadu alebo mydlom. Utrite do sucha čistou handričkou

Ako zaobchádzať s výrobkami s ochrannou fóliou

- Pred montážou odstráňte ochranný film z hrán a iných povrchov, ktoré by mohli byť montážou prekryté.
- Zostávajúcu ochrannú fóliu ponechajte, aby sa pri montáži výrobok nepoškodil. Po montáži zvyšok ochrannej fólie odstráňte.
- Pozor, povrchy môžu byť okamžite po odstránení ochrannej fólie mimoriadne citlivé na poškriabanie.
- Aby ste zlepšili ich odolnosť proti poškriabaniu, utrite povrchy jemným mydlovým roztokom (max. 1%, bez alkoholu alebo drsných čističiek).



Slovenščina

Očisti z mehko krpo, navlaženo z vodo, po potrebi lahko tudi z nežnim neabrazivnim čistilnim sredstvom. Obriši do suhega s čisto krpo.

Kako ravnati z izdelki z zaščitno folijo

- Pred montažo odstrani zaščitno folijo z robov in drugih površin, kjer lahko ta ovira montažo.
- Na preostalih mestih ne odstrani zaščitne folije, da se površina med montažo ne poškoduje.
- Pomni – takoj po odstranitvi folije je površina posebno občutljiva na praske.
- Za boljšo odpornost proti praskam površine prebriši z mehko krpo, navlaženo z blago milnico (največ 1% raztopino brez alkohola ali abrazivnih sredstev).



Bahasa Malaysia

Kesat sehingga bersih menggunakan kain yang dilembapkan di dalam air dan bahan cuci bukan pelepas atau sabun yang lembut, jika perlu. Kesat sehingga kering dengan kain bersih.

Cara pengendalian produk dengan lapisan perlindungan

- Sebelum pemasangan, tanggalkan lapisan pelindung dari tepi dan lain-lain permukaan yang boleh mengganggu pemasangan.
- Tinggalkan lapisan pelindung yang berbaki bagi mengelakkan kerosakan semasa pemasangan. Selepas pemasangan, tanggalkan semua lapisan pelindung.
- Perhatian - permukaan menjadi lebih sensitif pada calar sejurus selepas lapisan pelindung ditanggalkan.
- Bagi terus meningkatkan ketahanan pada calar, kesat permukaan dengan larutan sabun yang lembut (maks. 1%, tanpa alkohol atau pelepas.

Български

Ако е необходимо, почистете с кърпа навлажнена с вода и мек неабразивен препарат или сапун. После подсушете с чиста кърпа.

Работа с продукти покрити с предпазно фолио

- Преди да започнете сглобяването премахнете предпазното фолио от ългите и от други повърхност, ако пречат на сглобяването.
- Оставете останалото предпазно фолио с цел защита от щети по време на сглобяването. Премахнете изцяло предпазното фолио след като сте приключили със сглобяването.
- Забележка - след като премахнете предпазното фолио някои повърхности могат да бъдат по-уязвими на надраскване.
- За да направите артикула по-устойчив на надраскване, избършете повърхностите с мек сапунен разтвор (макс. 1%, без алкохол или абразивни елементи).



Türkçe

Suyla nemlendirilmis yumusak bir bez ve gerekirse hafif aşındırıcı olmayan bir deterjan veya sabunla silin. Temiz bir bezle kurulayın.

Koruyucu film ile kullanımı

- Montajdan önce, koruyucu filmi kenarlardan ve montaj engelleyebilecek diğer yüzeylerden çıkarın.
- Montaj sırasında hasar görmemesi için kalan koruyucu filmi bırakın. Montajdan sonra, tüm koruyucu filmi çıkarın.
- Not - koruyucu filmi çıkardıktan hemen sonra yüzeyler çiziklere karşı aşırı duyarlı olabilir.
- Çizilmelere karşı direnci arttırmak için, yüzeyleri yumuşak bir sabun çözeltisiyle silin (en fazla %1, alkol veya aşındırıcı madde içermemelidir).



Hrvatski

Očistiti krpom natopljenom u blagi deterđzent za pranje ili sapun, po potrebi. Osušiti čistom krpom.

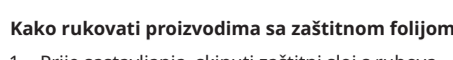

Kako rukovati proizvodima sa zaštitnom folijom

- Prije sastavljanja, skinuti zaštitni sloj s rubova ili ostalih površina koje mogu smetati pri sastavljanju.
- Ostaviti preostalu foliju radi izbjegavanja oštećenja nastalih tijekom sastavljanja. Nakon sastavljanja, skinuti svu zaštitnu foliju.
- Napomena – police mogu biti dodatno osjetljive na ogrebotine odmah po skidanju zaštitnog sloja.
- Za povećavanje otpornosti na ogrebotine, prebriši površine blagom sapunskom otopinom (maks. 1 %, bez alkohola ili abraziva).



中文

用柔軟的抹布蘸水或不含磨劑的中性清潔劑或肥皂擦拭干淨。用干淨布塊擦干。

如何处理帶保護膜的产品

- 組裝前，將邊緣和其他可能影响組裝的表面上的保護膜移除。
- 留下剩餘的保護膜，避免产品在組裝過程中受損。組裝完成后，移除所有保護膜。
- 注意：移除保護膜后，产品表面可能会更容易遭受刮擦。
- 为进一步防止刮擦，可用温和皂液擦拭表面（皂液浓度最高为1%，不含酒精或研磨剂）。

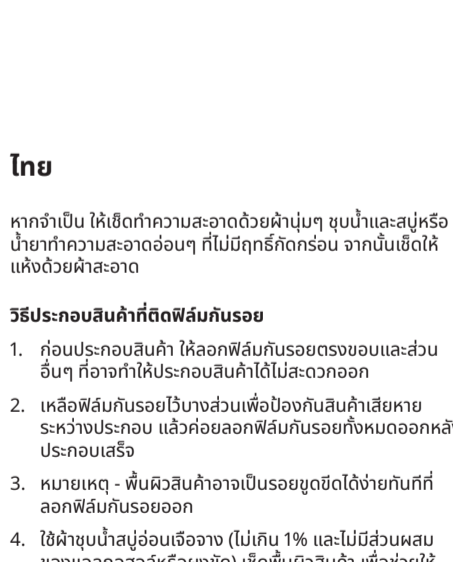

หากจำเป็น ให้ใช้ผ้าความละเอียดอย่างนุ่มๆ ชุบน้ำและสบู่นหรือป้ายผ้าความละเอียดอ่อนๆ ที่ไม่ถูกรักรีดหรือจากนั้นเช็ดให้แห้งด้วยผ้าสะอาด

วิธีประกอบสินค้าที่ติดฟิล์มกับรอย

- ก่อนประกอบสินค้า ให้ลอกฟิล์มกับรอยตรงขอบและส่วนอื่นๆ ที่อาจทำให้ประกอบสินค้าได้ไม่สะดวก
- เหลือฟิล์มกับรอยไว้บางส่วนเพื่อป้องกันสินค้าเสียหายระหว่างประกอบ แล้วค่อยลอกฟิล์มกับรอยทั้งหมดออกหลังประกอบเสร็จ
- หมายเหตุ - พื้นผิวสินค้าอาจเป็นรอยขีดได้ยากันที่ที่ลอกฟิล์มกับรอยออก
- ใช้ผ้าชุบน้ำปู้อ่อนเจือจาง (ไม่เกิน 1% และไม่มีส่วนผสมของแอลกอฮอล์หรือผงซัก) เช็ดพื้นผิวสินค้า เพื่อช่วยให้ nummดรอยขีดได้ดียิ่งขึ้น

Ελληνικά

Καθαρίστε με ένα μαλακό πανί μουσκεμένο σε νερό και ήπιο, μη διαβρωτικό απορρυπαντικό ή σαπούνι, αν είναι απαραίτητο. Σκουπίστε με ένα καθαρό και στεγνό πανί.

Χρήση προϊόντων με την προστατευτική μεμβράνη

- Πριν την συναρμολόγηση, αφαιρέστε την προστατευτική μεμβράνη από τις άκρες και από άλλες επιφάνειες που μπορεί να παρεμβαίνει στην συναρμολόγηση.
- Αφήστε την προστατευτική μεμβράνη που υπολείπεται για να προστατεύσετε την επιφάνεια κατά τη διάρκεια της συναρμολόγησης. Μετά την συναρμολόγηση αφαιρέστε όλη την μεμβράνη.
- Σημείωση-οι επιφάνειες μπορεί να είναι πολύ ευαίσθητες στις γρατσουνιές αμέσως μετά την αφαίρεση της μεμβράνης.
- Για να βελτιώσετε περισσότερο την αντοχή στις γρατσουνιές, καθαρίστε τις επιφάνειες με ένα ήπιο διάλυμα σαπουνιού (μέγ. 1%, χωρίς αλκοόλ ή διαλύτες).

