

English

Wipe clean with a soft cloth dampened in water and a mild non-abrasive washing-up detergent or soap, if necessary. Wipe dry with a clean cloth.

How to handle your products with protective film

- Before assembly, remove protective film from edges and other surfaces which may interfere with assembly.
- Leave remaining protective film to avoid damage during assembly. After assembly, remove all protective film.
- Note – surfaces may be extra sensitive to scratches immediately after removing the protective film.
- To further improve resistance to scratches, wipe surfaces with a mild soap solution (max. 1%, no alcohol or abrasives).

Deutsch

Mit einem in Wasser angefeuchteten weichen Tuch und, wenn nötig, mit schleifmittelfreiem Reinigungsmittel oder Seifenlösung säubern. Mit einem sauberen Tuch abtrocknen.

Behandlung von Produkten mit Schutzfolie

- Vor der Montage die Schutzfolie von der Kante und anderen Oberflächen entfernen, wo sie bei der Montage störend sein könnte.
- Die übrige Schutzfolie am Produkt belassen, um Schäden beim Montieren zu vermeiden. Die Schutzfolie nach der Montage komplett entfernen.
- Bitte beachten - direkt nach Entfernen der Schutzfolie kann die Oberfläche besonders empfindlich gegen Kratzer sein.
- Zur Erhöhung der Strapazierfähigkeit die Oberfläche mit einem weichen Tuch und einer milden Seifenlauge (max. 1%; keine alkoholhaltigen Mittel oder Schleifmittel) abwischen.

Français

Nettoyer à l'aide d'un chiffon doux imbibé d'eau et, si besoin, d'un détergent non abrasif ou de savon. Essuyer avec un chiffon propre.

Que faire du film protecteur sur les produits.

- Avant le montage, retirer le film de protection qui pourrait gêner, notamment au niveau des coins ou sur certaines surfaces.
- Laisser le film de de protection s'il ne gêne pas, afin d'éviter tout risque de dommages lors du montage. Après le montage, retirer tout le film protecteur.
- Attention : une fois le film retiré, la surface craint particulièrement les rayures.
- Pour renforcer la résistance à l'usure, nettoyer à l'aide d'un chiffon doux trempé dans de l'eau savonneuse (max. 1 % de détergent).

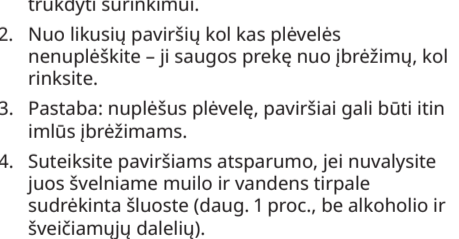
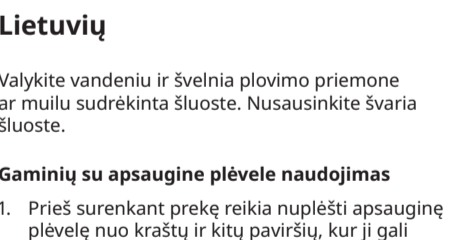
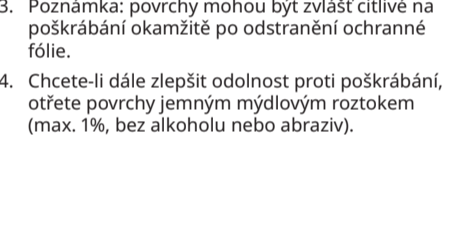
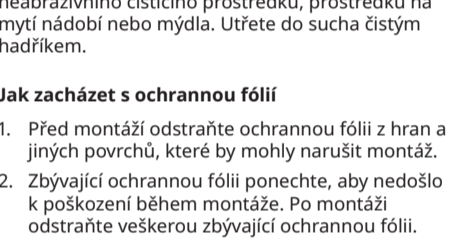
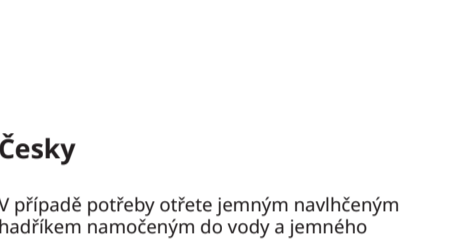

Nederlands

Schoonmaken met een vochtig doekje met water en evt. een schoonmaakmiddel zonder schuurmiddel, of een zeepoplossing. Nadrogen met een droge doek.

Omgaan met producten met beschermfolie

- Voor de montage: verwijder de beschermfolie van de randen en andere oppervlakken die de montage kunnen belemmeren.
- Laat de resterende beschermfolie zitten om beschadigingen tijdens de montage te voorkomen.
- Let op - oppervlakken kunnen meteen nadat de beschermfolie verwijderd is extra gevoelig zijn voor krassen.
- Om de slijtvastheid nog verder te verbeteren, de oppervlakken afnemen met een milde zeepoplossing (max. 1 %, geen alcohol of schuurmiddel).

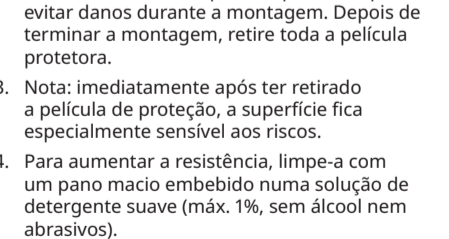
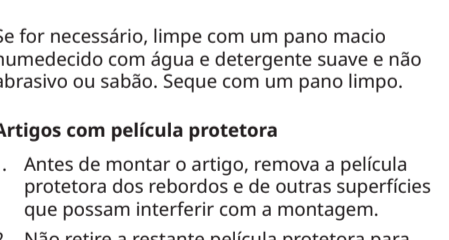
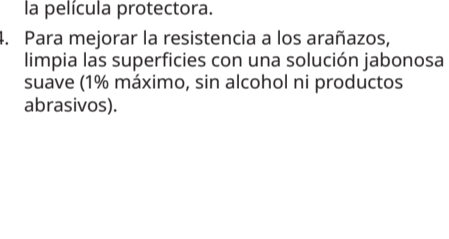
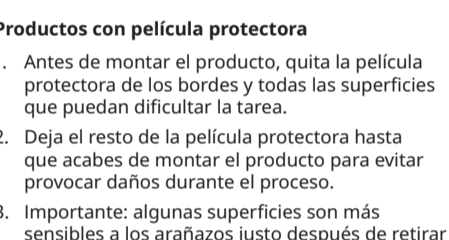
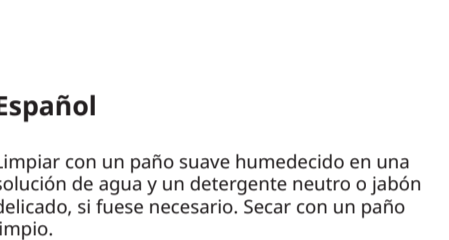

Dansk

Tørres eventuelt af med en blød, fugtig klud tilsat et mildt, ikke-slibende opvaskemiddel eller sæbe. Tør efter med en ren, tør klud.

Sådan håndterer du produkter med beskyttelsesfilm

- Før du samler produktet, skal du fjerne beskyttelsesfilmen fra kanter og andre overflader, der kan vanskeliggøre montering.
- Lad beskyttelsesfilmen sidde de øvrige steder, så du ikke beskadiger produktet under montering. Fjern al beskyttelsesfilm efter montering.
- BEMÆRK!** Umiddelbart efter at du har fjernet beskyttelsesfilmen, kan overfladen være særligt modtagelig over for ridser.
- For at gøre overfladen stærkere, skal du tørre den af med en blød klud og en mild sæbeopløsning (maks. 1%, ingen alkohol eller slipemidler).

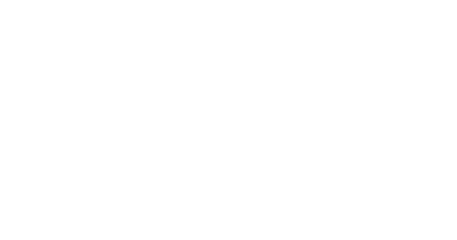
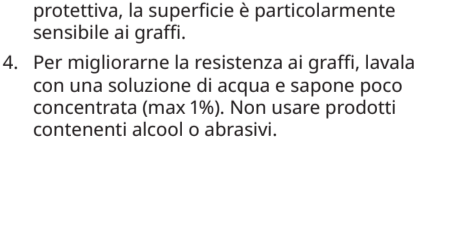
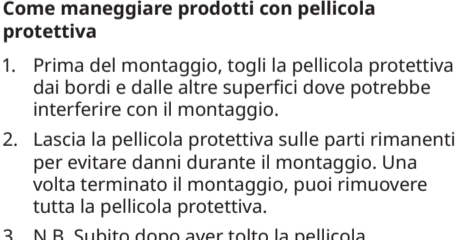
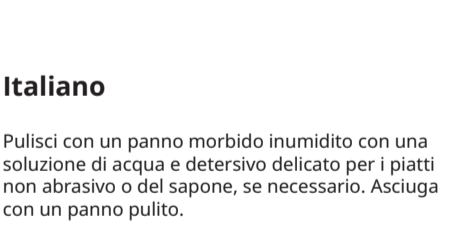
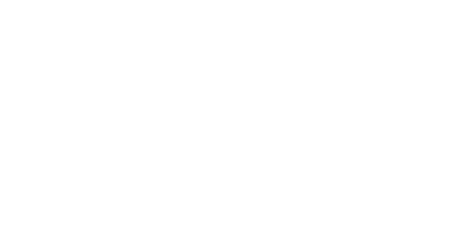

Íslenska

Þrífðu með mjúkum rökum klút og mildu hreinsiefni án svarfefna eða sápu, ef nauðsyn krefur. Þurrkaðu með hreinum klút.

Meðhöndlun vara með varnarfilmu

- Fjarlægðu filmuna af brúnum og öðru yfirborði sem gæti haft áhrif á samsetninguna.
- Skildu þá filmu sem eftir er til að koma í veg fyrir skemmdir meðan þú setur saman vöruna. Eftir samsetningu skal fjarlægja alla varnarfilmu.
- Athugaðu – yfirborð gæti verið mjög viðkvæmt fyrir rispum rétt eftir að filman hefur verið fjarlægð.
- Þurrkaðu yfirborðið með mildri sápulausn (hám. 1%, án alkóhóls eða svarfefna) til að auka þol yfirborðsins gegn rispum.

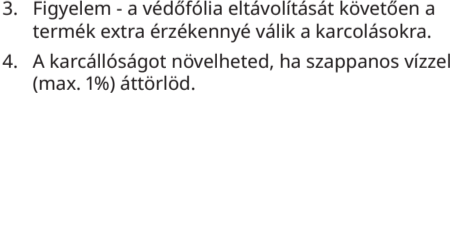
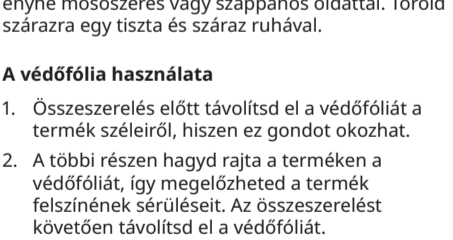
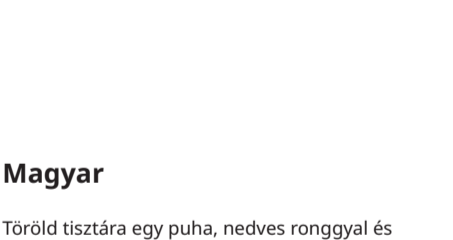

Norsk

Tørk av med en myk klut fuktet med vann og litt mildt oppvaskemiddel eller såpe om nødvendig. Tørk over med en ren klut.

Slik håndterer du produkter med beskyttelsesfilm

- Før montering må all beskyttelsesfilm fjernes fra kanter og andre flater som kan komme i veien under montering.
- Behold den øvrige beskyttelsesfilmen for å unngå å skade produktet under montering. Etter montering, all beskyttelsesfilm fjernes.
- Merk – flatene kan være ekstra mottagelige for skraper umiddelbart etter at beskyttelsesfilmen er fjernet.
- For å styrke motstanden mot riper ytterligere, kan overflaten tørkes over med mildt såpevann (maks 1 %, uten alkohol eller slipemiddel).

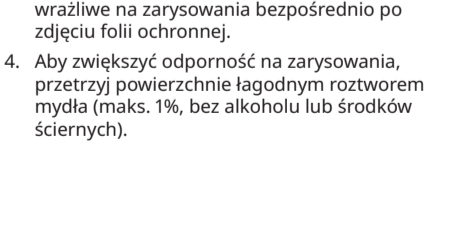
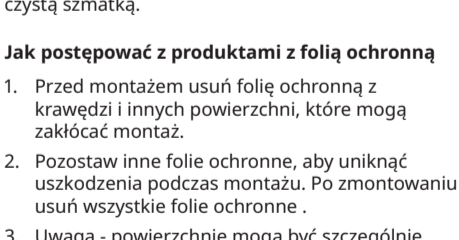
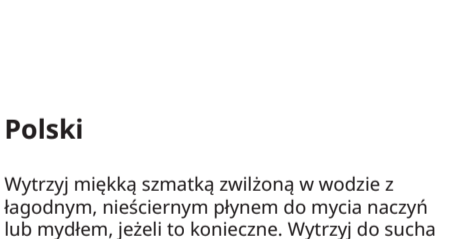

Suomi

Pyyhitään pehmeällä, veteen kostutetulla liinalla. Tarvittaessa voidaan käyttää mietoa puhdistusainetta, joka ei sisällä hankaavia ainesosia. Kuivataan puhtaalla liinalla.

Suojakalvillisten tuotteiden käsittely

- Poista ennen kokoamisen aloittamista suojakalvo tuotteen reunoista ja muista pinnoista, joissa se voi häiritä kokoamista.
- Jätä loput suojakalvot paikalleen vaurioiden välttämiseksi kokoamisen aikana. Poista loput suojakalvot, kun kokoaminen on suoritettu.
- Huomioi, että pinnat voivat olla erityisen herkkiä naarmuille heti suojakalvon poistamisen jälkeen.
- Naarmunkeston parantamiseksi pyyhi pinnat miedolla saippualuoksella (enintään 1 %, ei alkoholia tai hankaavia aineita).

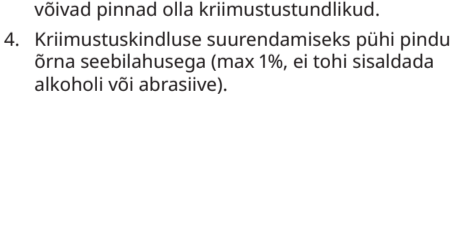
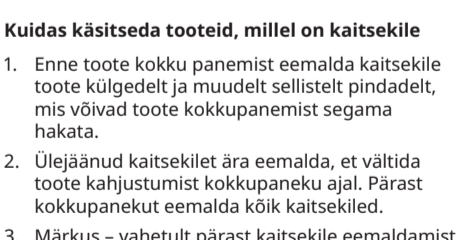
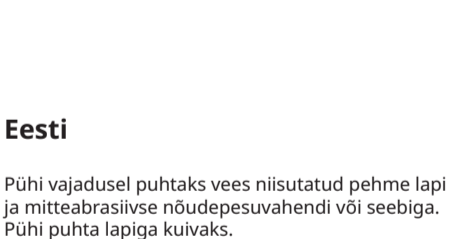

Svenska

Rengör med mjuk trasa fuktad i vatten och ev. rengöringsmedel utan slipmedel eller tvållösning. Eftertorka med torr trasa.

Så hanterar du dina produkter med skyddsfilm

- Innan montering, ta bort skyddsfilm från kanter och andra ytor som kan störa monteringen.
- Låt resterande skyddsfilm sitta kvar för att undvika skador under monteringen. Efter montering, ta bort all skyddsfilm.
- Obs – ytorna kan vara extra känsliga för repor direkt efter att skyddsfilmen tagits bort.
- För att förbättra tåligheten ytterligare, torka av ytorna med mild tvållösning (max 1%, ingen alkohol eller slipmedel).

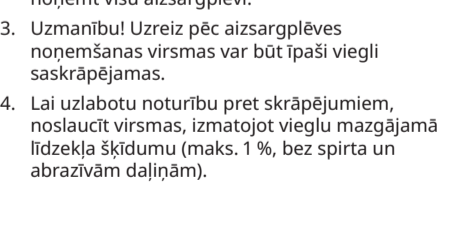
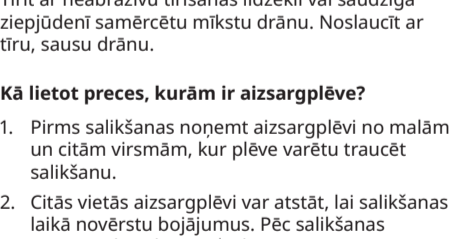
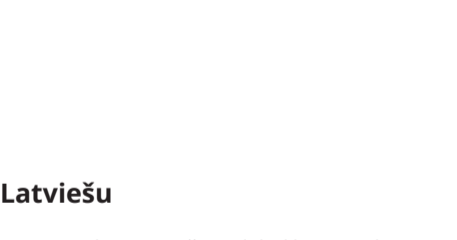

Česky

V případě potřeby otřete jemným navlhčeným hadříkem namočeným do vody a jemného neabrazivního čistícího prostředku, prostředku na mytí nádobí nebo mydla. Utřete do sucha čistým hadříkem.

Jak zacházet s ochrannou fólií

- Před montáží odstraňte ochrannou fólii z hran a jiných povrchů, které by mohly narušit montáž.
- Zbývající ochrannou fólii ponechte, aby nedošlo k poškození během montáže. Po montáži odstraňte veškerou zbývající ochrannou fólii.
- Poznámka: povrchy mohou být zvlášt citlivé na poškrábání okamžitě po odstranění ochranné fólie.
- Chcete-li dále zlepšit odolnost proti poškrábání, otřete povrchy jemným mydlovým roztokem (max. 1%, bez alkoholu nebo abraziv).

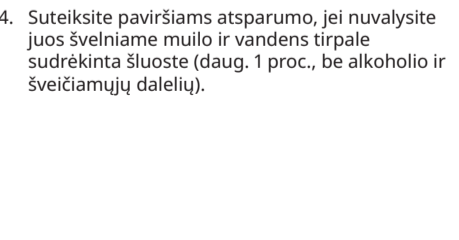
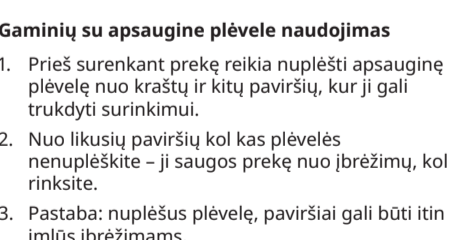
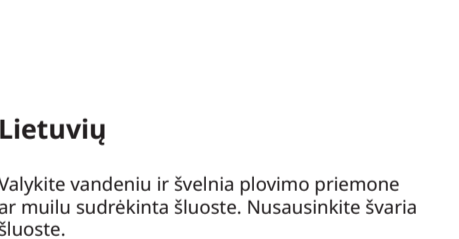

Español

Limpiar con un paño suave humedecido en una solución de agua y un detergente neutro o jabón delicado, si fuese necesario. Secar con un paño limpio.

Productos con película protectora

- Antes de montar el producto, quite la película protectora de los bordes y todas las superficies que puedan dificultar la tarea.
- Deja el resto de la película protectora hasta que acabes de montar el producto para evitar provocar daños durante el proceso.
- Importante: algunas superficies son más sensibles a los arañazos justo después de retirar la película protectora.
- Para mejorar la resistencia a los arañazos, limpia las superficies con una solución jabonosa suave (1% máximo, sin alcohol ni productos abrasivos).

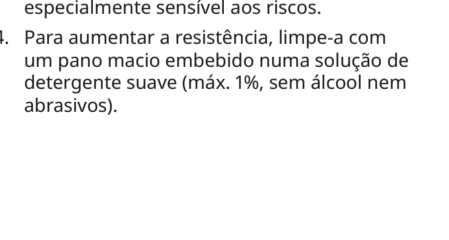
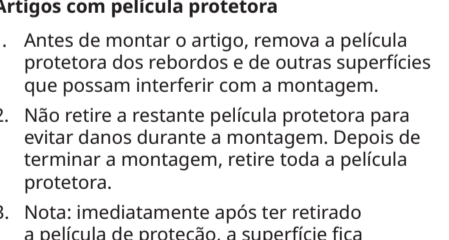
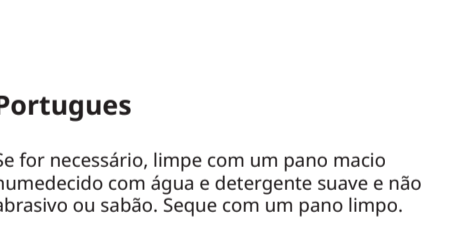

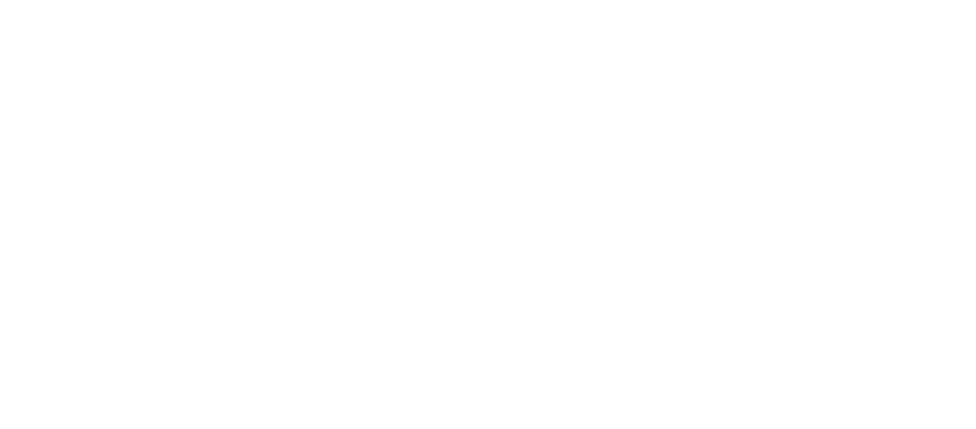
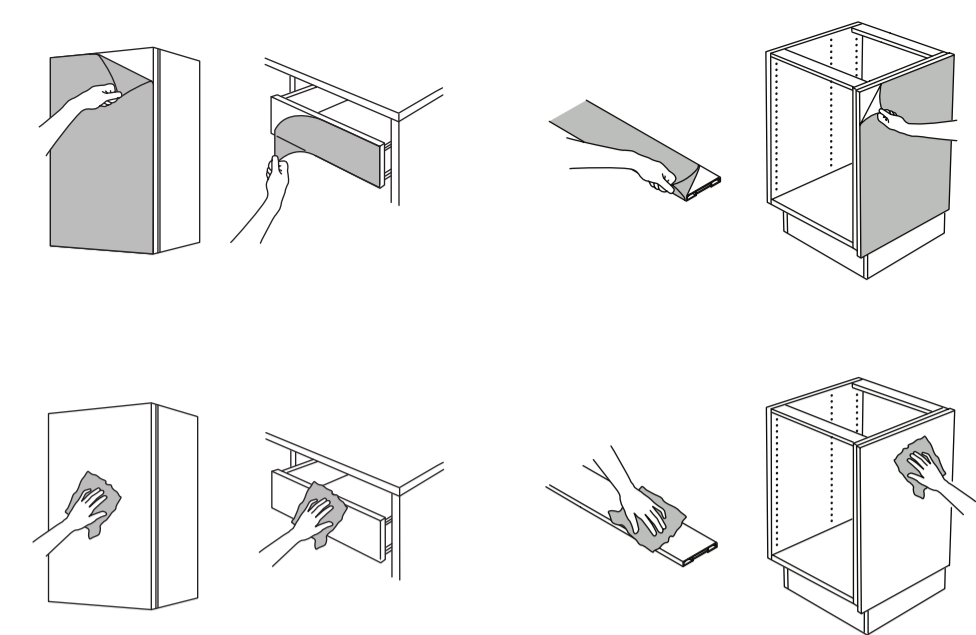

Русский

Протирать мягкой тканью, смоченной в воде с добавлением при необходимости мягкого неабразивного моющего средства или мыла. Затем вытирать чистой тканью.

Как обращаться с товарами с защитной пленкой

- Перед сборкой удалите защитную пленку с кромок и других поверхностей, где она может помешать сборке.
- Не удаляйте защитную пленку с других поверхностей, чтобы избежать повреждений при сборке. После сборки удалите всю защитную пленку.
- Внимание! Поверхности сразу после удаления защитной пленки могут быть очень чувствительны к царапинам .
- Для повышения устойчивости к царапинам протрите поверхности тканью, смоченной в слабом мыльном растворе (не более 1%, без спирта и абразивов).



한국어

부드러운 천을 물에 적신 뒤 비마모성 주방세제나 비누를 묻혀 닦아주세요. 깨끗한 천으로 물기를 닦아 마무리하세요.

보호 필름을 이용한 제품 취급

- 조립하기 전에 원활한 조립을 위해 모서리와 표면에 붙어 있는 보호 필름을 제거해 주세요.
- 다른 보호 필름은 조립 중 손상을 방지하기 위해 남겨주세요. 조립 후 모든 보호 필름을 제거하세요.
- 주의 - 보호 필름을 제거한 직후 표면이 긁힘에 매우 민감할 수 있습니다.
- 긁힘을 방지하기 위해 부드러운 비누 용액으로 표면을 닦아주세요. (최대 1%, 알코올이나 연마제가 없는 성분).

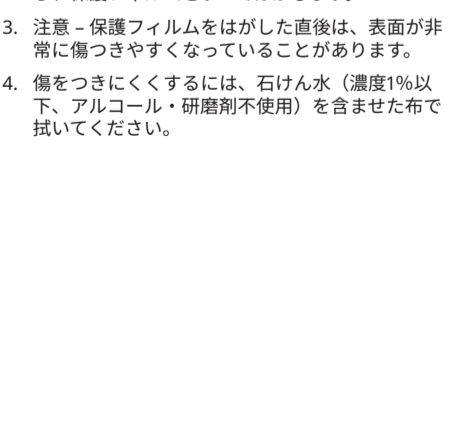
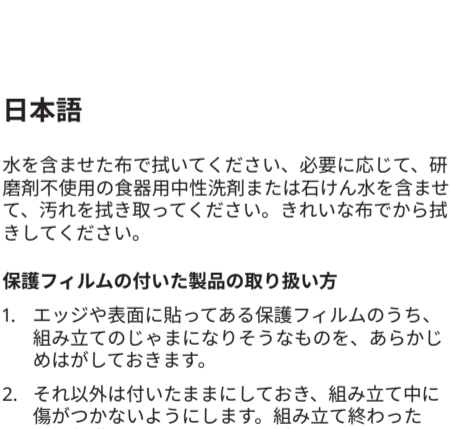
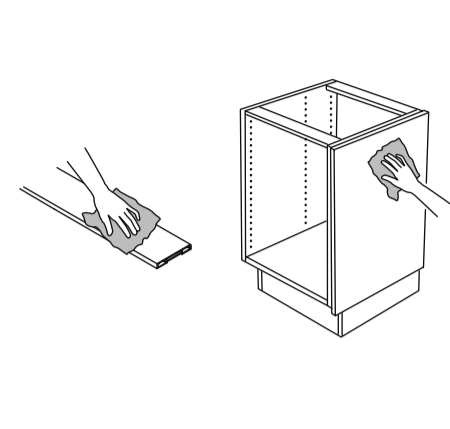
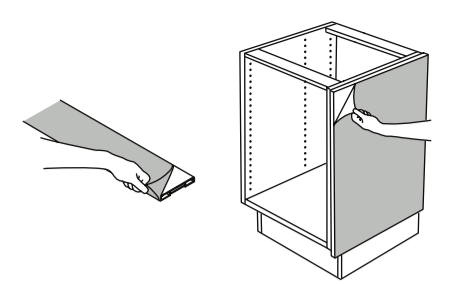

Româna

Curăța cu o cârpă înmuiată în apă și detergent delicat, neabraziv, sau săpun, dacă este necesar. Șterge cu o cârpă uscată.

Cum să folosești produse cu folie de protecție

- Înainte de asamblare, scoate folia de protecție de pe margini și alte suprafețe care pot interfera cu asamblarea.
- Lasă restul foliei de protecție pentru a evita deteriorarea în timpul asamblării. După asamblare, scoate toată folia de protecție.
- Notă - suprafețele pot fi foarte sensibile la zgârieturi imediat după eliminarea foliei de protecție.
- Pentru a îmbunătăți rezistența la zgârieturi, șterge suprafețele cu o soluție de detergent delicat (max. 1%, fără alcool sau substanțe abrazive).



Srpski

Čisti mekom krpom nakvašenom vodom i blagom neabrazivnom tečnošću za sude ili sapunom, po potrebi. Osuši čistom krpom.

Kako da rukuješ proizvodima sa zaštitnom folijom

- Pre sastavljanja, ukloni foliju s ivica i drugih površina koje mogu uticati na sastavljanje.
- Ostavi preostalu zaštitnu foliju da izbegneš oštećenja tokom sastavljanja. Po sastavljanju, ukloni zaštitnu foliju.
- Napomena — površine mogu biti posebno osetljive na ogrebotine neposredno posle uklanjanja zaštitne folije.
- Da dodatno poboljšaš otpornost na ogrebotine, prebriši površine blagim rastvorom sapuna (maks. 1%, bez alkohola i abraziva).

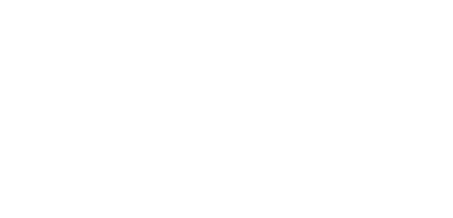
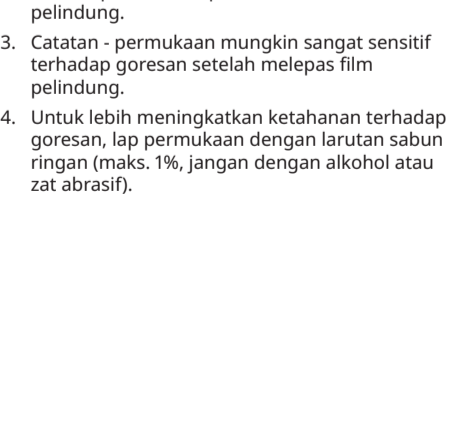

Slovensky

V prípade potreby utrite mäkkou handričkou namočenou vo vode a jemným neabrazívnym čistiacim prostriedkom na umývanie riadu alebo mydlom. Utrite do sucha čistou handričkou

Ako zaobchádzať s výrobkami s ochrannou fóliou

- Pred montážou odstráňte ochranný film z hrán a iných povrchov, ktoré by mohli byť montážou prekryté.
- Zostávajúcu ochrannú fóliu ponechajte, aby sa pri montáži výrobok nepoškodil. Po montáži zvyšok ochrannej fólie odstráňte.
- Pozor, povrchy môžu byť okamžite po odstránení ochrannej fólie mimoriadne citlivé na poškriabanie.
- Aby ste zlepšili ich odolnosť proti poškriabaniu, utrite povrchy jemným mydlovým roztokom (max. 1%, bez alkoholu alebo drsných čističiek).



Slovenščina

Očisti z mehko krpo, navlaženo z vodo, po potrebi lahko tudi z nežnim neabrazivnim čistilnim sredstvom. Obriši do suhega s čisto krpo.

Kako ravnati z izdelki z zaščitno folijo

- Pred montažo odstrani zaščitno folijo z robov in drugih površin, kjer lahko ta ovira montažo.
- Na preostalih mestih ne odstrani zaščitne folije, da se površina med montažo ne poškoduje.
- Pomni – takoj po odstranitvi folije je površina posebno občutljiva na praske.
- Za boljšo odpornost proti praskam površine prebriši z mehko krpo, navlaženo z blago milnico (največ 1% raztopino brez alkohola ali abrazivnih sredstev).

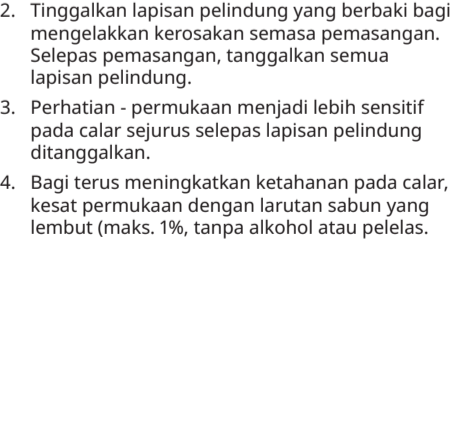
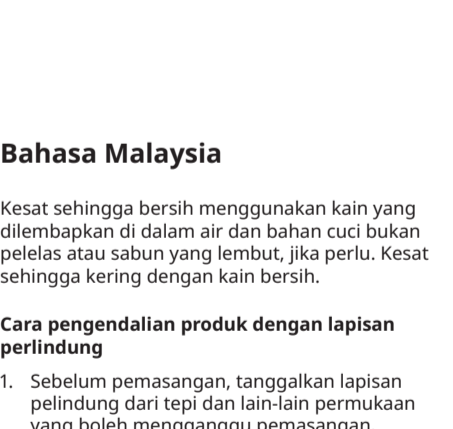

Български

Ако е необходимо, почистете с кърпа навлажнена с вода и мек неабразивен препарат или сапун. После подсушете с чиста кърпа.

Работа с продукти покрити с предпазно фолио

- Преди да започнете сглобяването премахнете предпазното фолио от ъглите и от други повърхност, ако пречат на сглобяването.
- Оставете останалото предпазно фолио с цел защита от щети по време на сглобяването. Премахнете изцяло предпазното фолио след като сте приключили със сглобяването.
- Забележка - след като премахнете предпазното фолио някои повърхности могат да бъдат по-уязвими на надраскване.
- За да направите артикула по-устойчив на надраскване, избършете повърхностите с мек сапунен разтвор (макс. 1%, без алкохол или абразивни елементи).

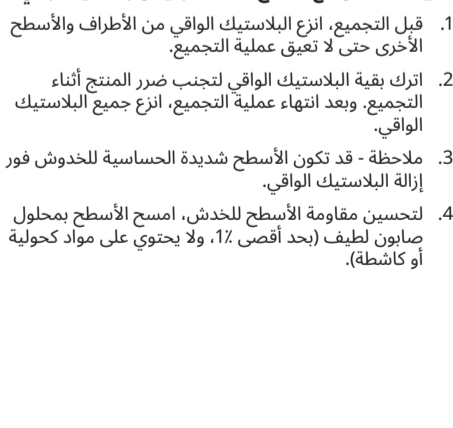
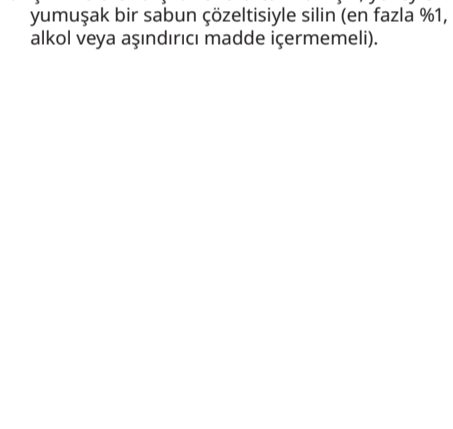
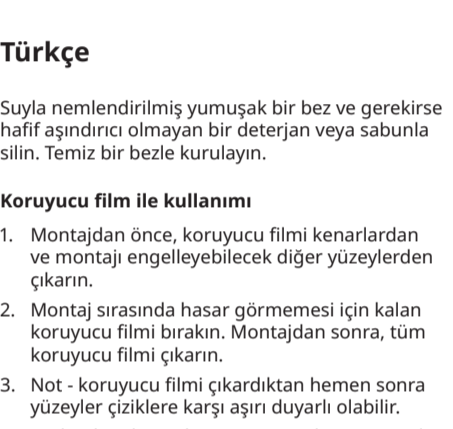

Hrvatski

Očistiti krpom natopljenom u blagi deterđent za pranje ili sapun, po potrebi. Osušiti čistom krpom.

Kako rukovati proizvodima sa zaštitnom folijom

- Prije sastavljanja, skinuti zaštitni sloj s rubova ili ostalih površina koje mogu smetati pri sastavljanju.
- Ostaviti preostalu foliju radi izbjegavanja oštećenja nastalih tijekom sastavljanja. Nakon sastavljanja, skinuti svu zaštitnu foliju.
- Napomena – police mogu biti dodatno osjetljive na ogrebotine odmah po skidanju zašitnog sloja.
- Za povećavanje otpornosti na ogrebotine, prebriši površine blagom sapunskom otopinom (maks. 1 %, bez alkohola ili abraziva).

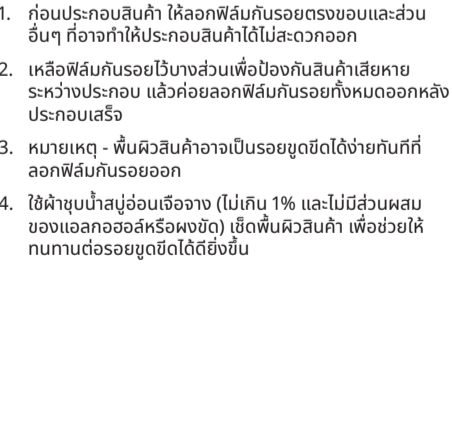
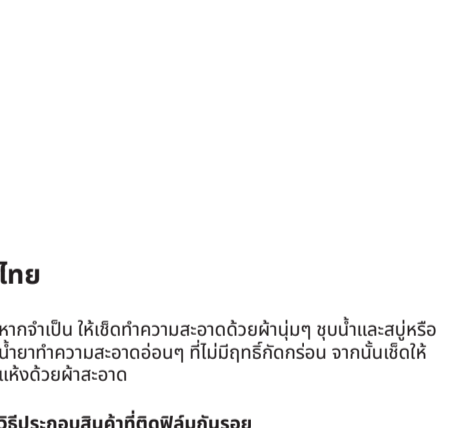
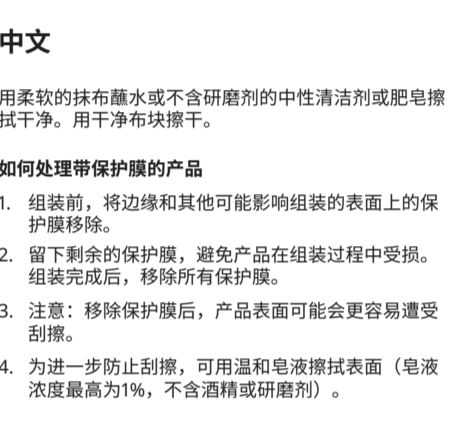

Ελληνικά

Καθαρίστε με ένα μαλακό πανί μουσκεμένο σε νερό και ήπιο, μη διαβρωτικό απορρυπαντικό ή σαπούνι, αν είναι απαραίτητο. Σκουπίστε με ένα καθαρό και στεγνό πανί.

Χρήση προϊόντων με την προστατευτική μεμβράνη

- Πριν την συναρμολόγηση, αφαιρέστε την προστατευτική μεμβράνη από τις άκρες και από άλλες επιφάνειες που μπορεί να παρεμβαίνει στην συναρμολόγηση.
- Αφίρστε την προστατευτική μεμβράνη που υπολείπεται για να προστατεύσετε την επιφάνεια κατά τη διάρκεια της συναρμολόγησης. Μετά την συναρμολόγηση αφαιρέστε όλη την μεμβράνη.
- Σημείωση-οι επιφάνειες μπορεί να είναι πολύ ευαίσθητες στις γρατσουνιές αμέσως μετά την αφαίρεση της μεμβράνης.
- Για να βελτιώσετε περισσότερο την αντοχή στις γρατσουνιές, καθαρίστε τις επιφάνειες με ένα ήπιο διάλυμα σαπουνιού (μέγ. 1%, χωρίς αλκοόλ ή διαλύτες).

