

SOLVINDEN

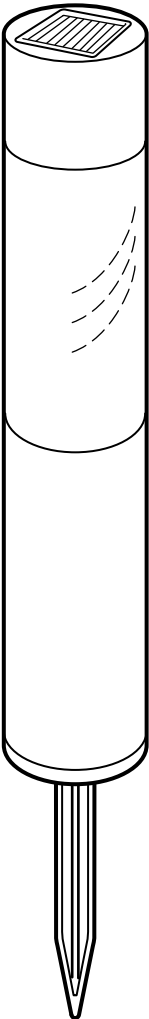

Design and Quality
IKEA of Sweden

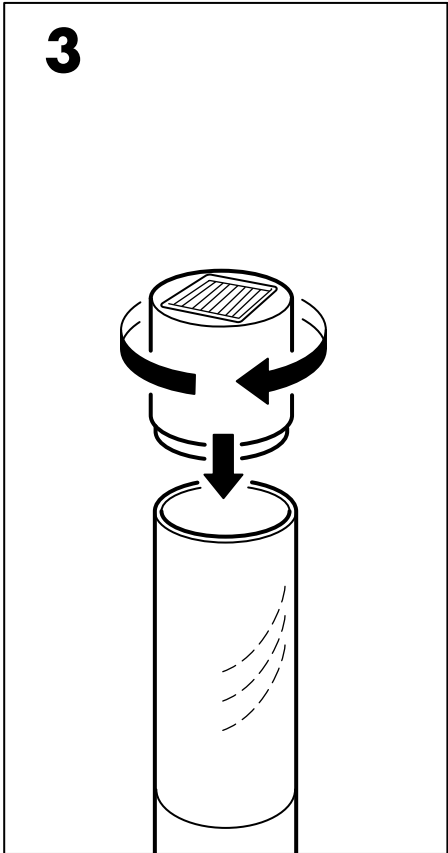

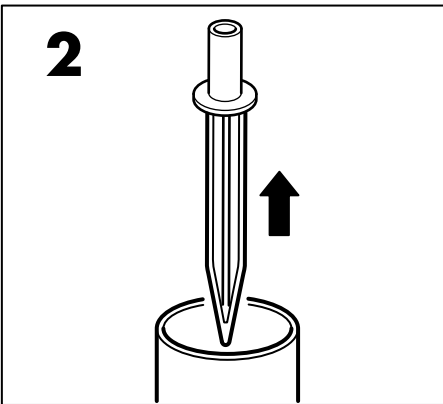
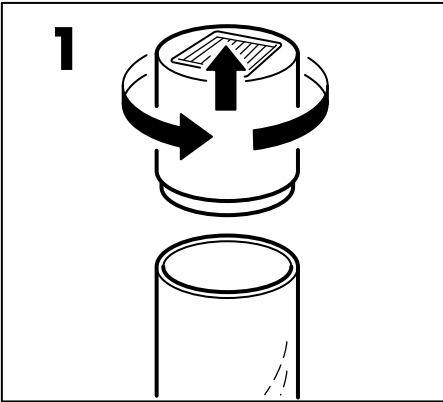
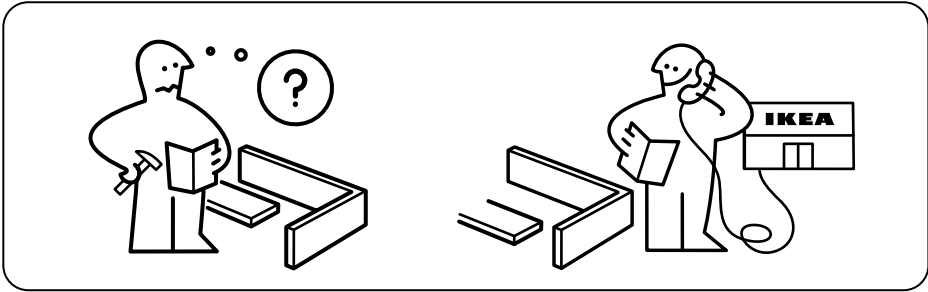
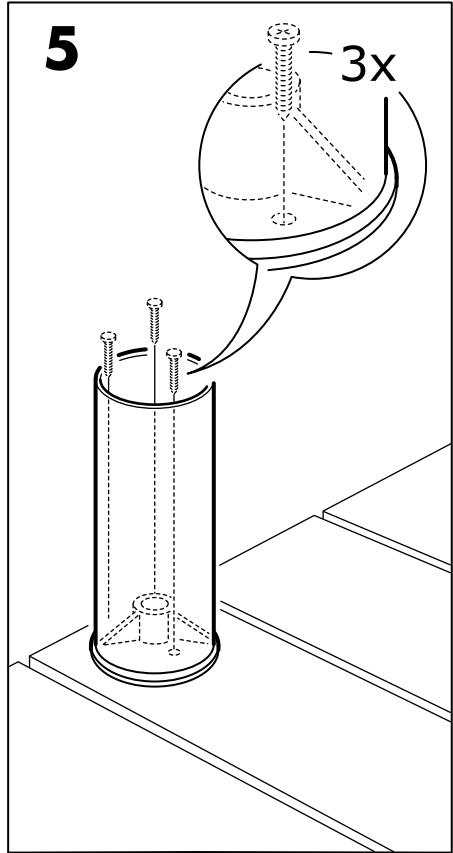
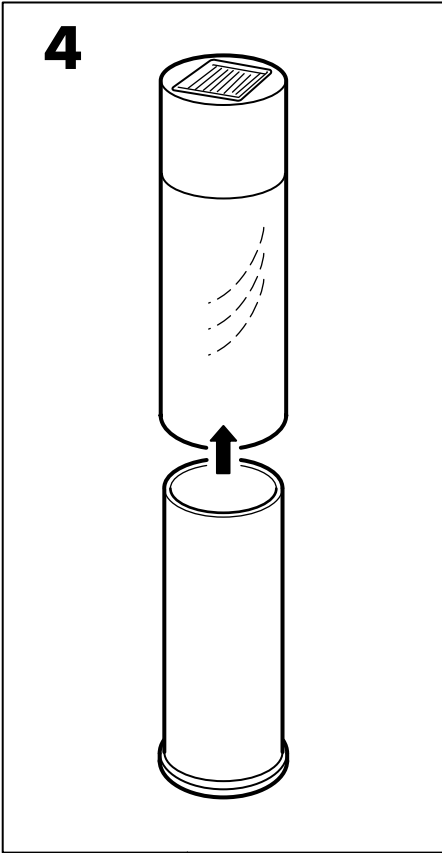
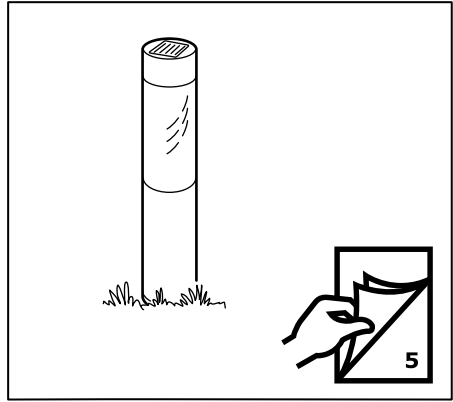
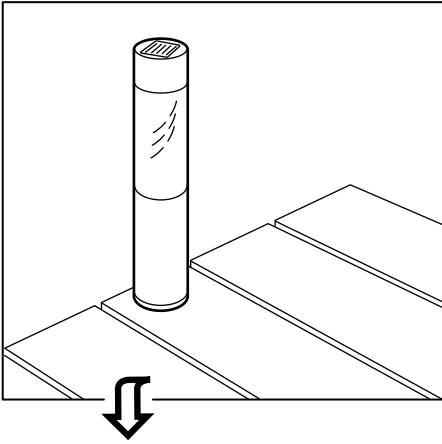

6

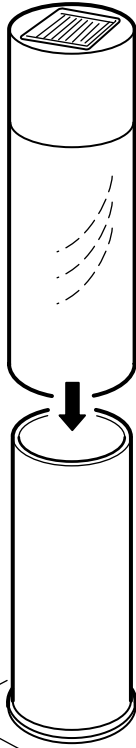

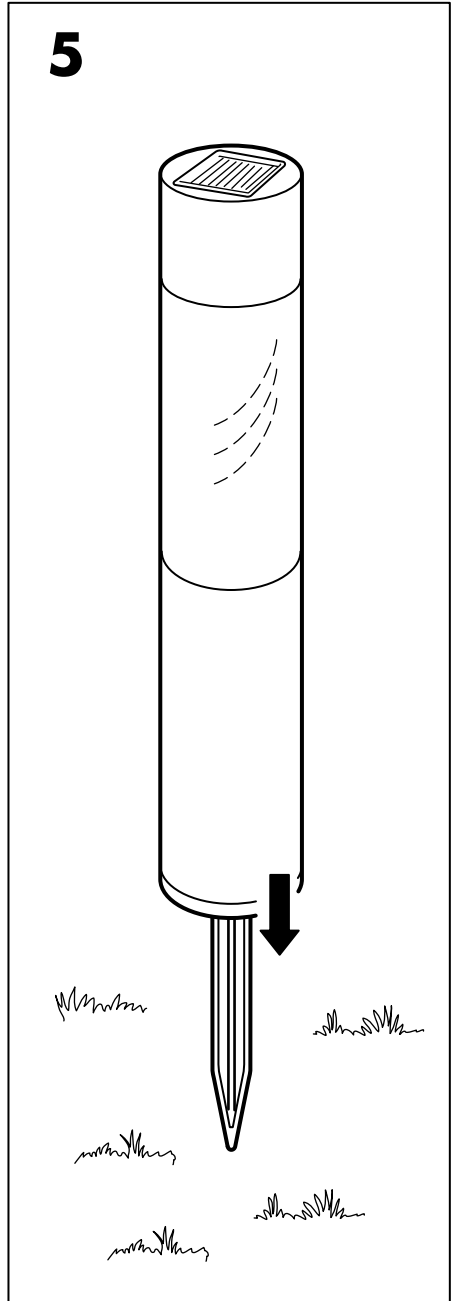
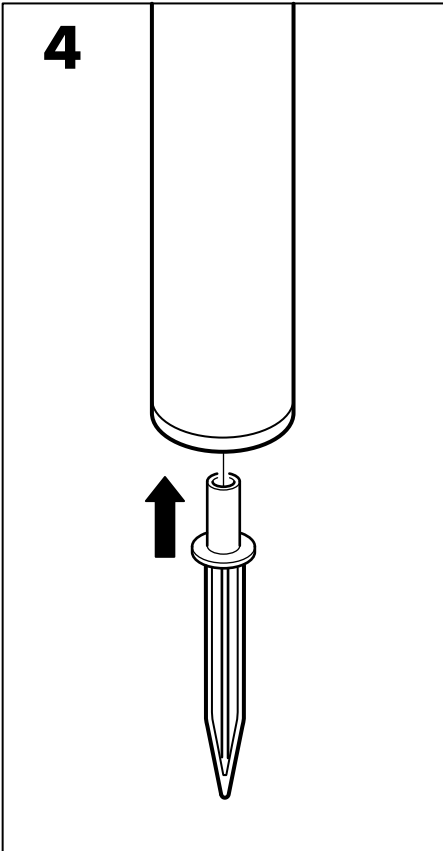
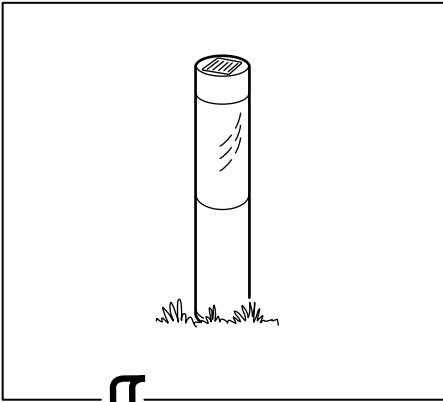

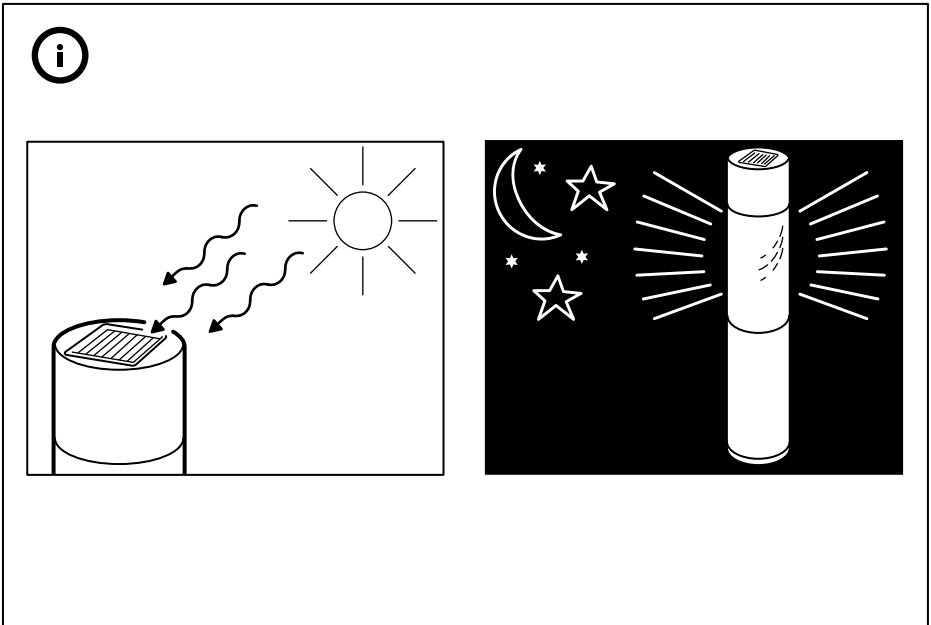
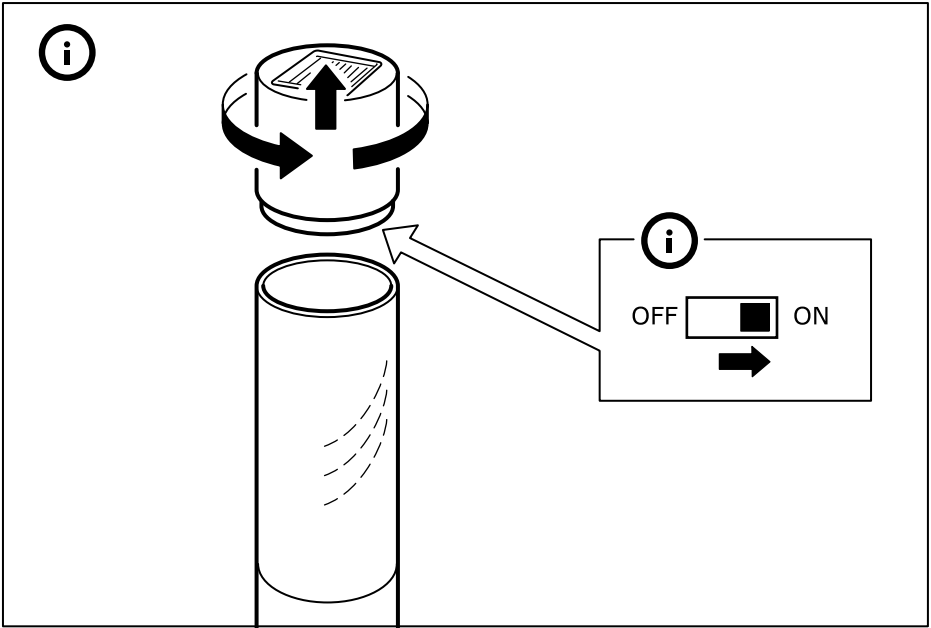

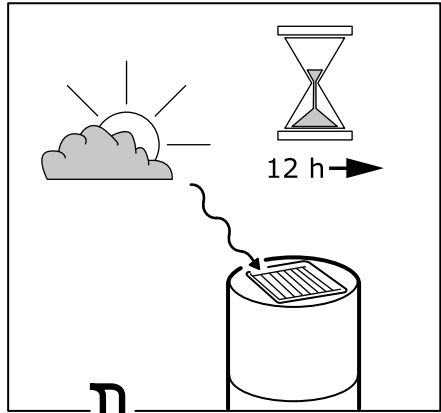
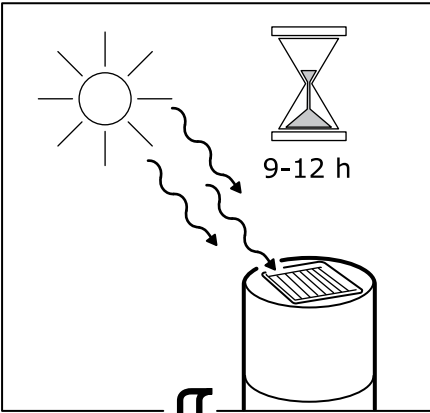
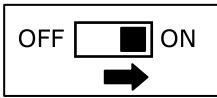

12 h

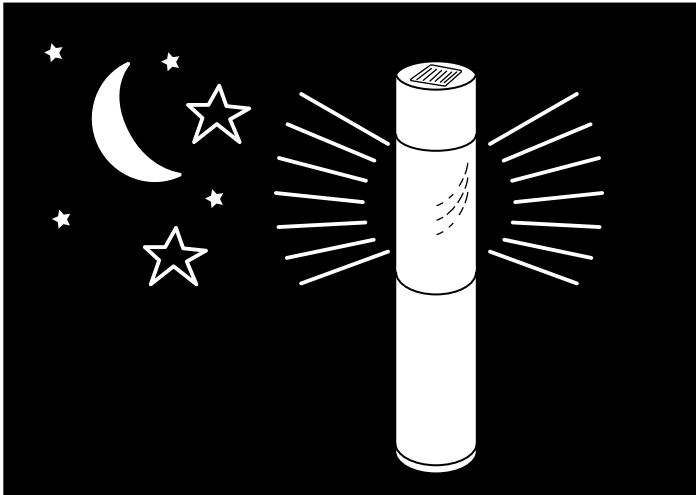



2x

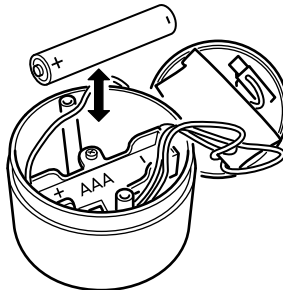
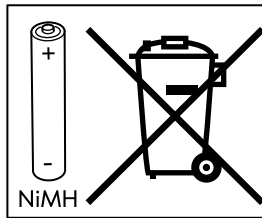
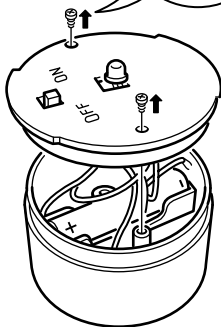

2x

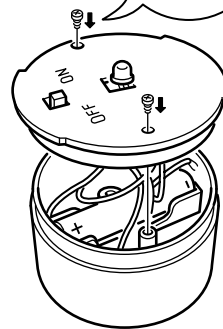

ENGLISH

After approximately 2 years, the rechargeable battery need to be replaced when the lamp don't light up. Replace with Ni-MH rechargeable 1.2V, 750mAH, AAA type batteries.

Light Source is LED (Light Emitting Diodes), the LED can not be exchanged by customer.

SAVE THESE INSTRUCTIONS FOR FUTURE USE.

DEUTSCH

Wenn die Leuchte nicht mehr brennt, muss der Akku nach ca. 2 Jahren ausgetauscht werden. Alte Akkus mit neuen vom Typ Ni-MH 1,2V, 750mAh, AAA ersetzen.

Die Lichtquelle dieses Produkts besteht aus Leuchtdioden (LED), die vom Kunden nicht ausgetauscht werden können.

DIESE ANLEITUNG FÜR KÜNFTIGEN GEBRAUCH AUFHEBEN.

FRANÇAIS

Après environ 2 ans, la pile rechargeable doit être remplacée lorsque la lampe ne s'allume plus. La remplacer avec une pile rechargeable Ni-MH, 1,2V, 750mAh, de type AAA.

La source lumineuse est une LED (Diode Electro Luminescente). La LED ne peut être changée par le client.

CONSERVER CES INSTRUCTIONS POUR VOUS Y REPORTER ULTÉRIEUREMENT.

NEDERLANDS

Na ongeveer 2 jaar moet de oplaadbare batterij worden vervangen wanneer de lamp niet meer aangaat. Vervang de batterij door een oplaadbare batterij van het type Ni-MH 1,2V, 750mAh, AAA.

De lichtbron is een led-lamp. Led-verlichting kan niet door de klant worden vervangen.

BEWAAR DEZE INSTRUCTIES VOOR TOEKOMSTIG GEBRUIK.

DANSK

Efter ca. 2 år skal de genopladelige batterier udskiftes, hvis lampen ikke lyser. Udskift med genopladelige Ni-MH 1,2V, 750 mAh, AAA-batterier. Pæren er en LED-pære, som ikke kan udskiftes af kunden.

GEM DISSE ANVISNINGER TIL FREMTIDIG BRUG.

ÍSLENSKA

Eftir um það bil 2 ár þarf að skipta út endurhlaðanlegu rafhlöðunni, þegar hættir að kvikna á lampanum. Endurnýjið með Ni-MH 1.2V, 750mAh, AAA endurhlaðanlegum rafhlöðum. Ljósgejafi er LED (ljósdíóða), viðskiptavinir geta ekki skipt út LED.

GEYMIÐ LEIÐBEININGARNAR FYRIR FREKARI NOTKUN.

NORSK

Etter cirka 2 år må det oppladbare batteriet skiftes ut, når lampen ikke lyser lenger. Skift batteriet med et oppladbart Ni-MH 1,2 V, 750 mAh, AAA-batteri. Lyskilden er LED (Light Emitting Diode). LED-pærene kan ikke skiftes av kunden.

SPAR PÅ DISSE INSTRUKSJONENE FOR FREMTIDIG BRUK.

SUOMI

Noin kahden vuoden kuluttua ladattava akku on vaihdettava, kun lamppu ei enää syty. Tilalle on vaihdettava ladattava 1,2 V:n Ni-MH-akku (750 mAh, AAA). Valonlähteenä led-lampun, joita ei voi vaihtaa itse.

SÄILYTÄ NÄMÄ OHJEET MYÖHEMPÄÄ TARVETTA VARTEN.



2x

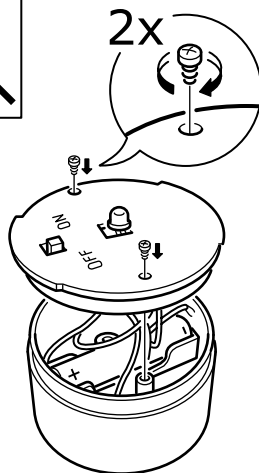
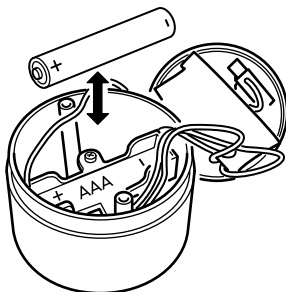
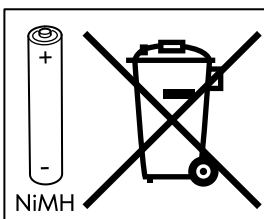
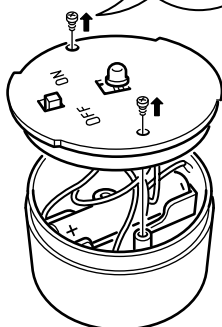

SVENSKA

Efter ungefär 2 år behöver det laddningsbara batteriet bytas ut när lampan inte längre tänds. Ersätt med laddningsbara batterier av typen Ni-MH 1,2V, 750mAh, AAA.

Ljuskällan är LED. LED-belysning kan inte bytas ut av kunden.

SPARA DESSA INSTRUKTIONER FÖR FRAMTIDA BRUK.

ČESKY

Přibližně po 2 letech je potřeba dobíjecí baterie vyměnit, když už se lampa nerozsvítí. Nahraďte je dobíjecími bateriemi Ni-MH 1,2 V, 750 mAh, typu AAA. Zdroj světla je LED (světlo vydávající diody), žárovku LED zákazník vyměnit nemůže.

TYTO INSTRUKCE SI ODLOŽTE PRO BUDOUCÍ POUŽITÍ.

ESPAÑOL

Después de unos dos años, cuando la lámpara no se enciende, la pila recargable se debe reemplazar por pilas recargables Ni-Mh de 1,2V, 750 mAh, AAA.

La fuente de luz es LED (diodos emisores de luz), que el cliente no puede reemplazar.

GUARDA ESTAS INSTRUCCIONES PARA EL FUTURO.

ITALIANO

Dopo circa 2 anni, quando la lampada non si accende, è necessario cambiare la batteria ricaricabile. Sostituiscila con batterie ricaricabili Ni-MH 1,2V, 750mAh, AAA.

La fonte luminosa di questo prodotto è costituita da LED (Light Emitting Diodes), non sostituibili dal cliente.

CONSERVA QUESTE ISTRUZIONI PER ULTERIORI CONSULTAZIONI.

MAGYAR

Nagyjából 2 év elteltével ki kell cserélni az újratölthető elemet, ha a lámpa nem kapcsolna be. Cseréld Ni-Mh újratölthető, 1,2 V, 750 mAh, AAA típusú elemre.

A fényforrás LED (Light Emitting Diode - Fénykibocsátó Dióda), amit a vásárló nem tud kicserélni.

ŐRIZD MEG EZEKET AZ UTASÍTÁSOKAT.

POLSKI

Po około 2 latach akumulatory należy wymienić, jeżeli lampa się nie świeci. Wymień na akumulatory Ni-MH 1,2 V, 750mAh, typ AAA.

Źródłem światła jest dioda LED (Light Emitting Diodes), która nie może być wymieniona przez klienta.

ZACHOWAJ NINIEJSZĄ INSTRUKCJĘ DO WYKORZYSTANIA W PRZYSZŁOŚCI.

EESTI

Umbes kahe aasta pärast, kui lamp enam ei sütti, tuleb laetav patarei asendada. Asenda Ni-MH laetava 1,2V, 750mAh, AAA tüüpi patareiga.

Valgusallikas on LED (valgust kiirgavad diodid), seda ei saa klient vahetada.

SÄILITA NEED JUHISED EDASPIDI KASUTAMISEKS.

LATVIEŠU

Pēc aptuveni 2 gadiem, ja lampa vairs nedeg, lādējamās baterijas nepieciešams nomainīt. Nomainiet tās pret 1,2V, 750mAh, AAA tipa Ni-MH lādējamām baterijām.

LED spuldžu nomaigū nedrīkst veikt patstāvīgi!

SAGLABĀJIET ŠO INSTRUKCIJU TURPMĀKAI UZZIŅAI.



2x

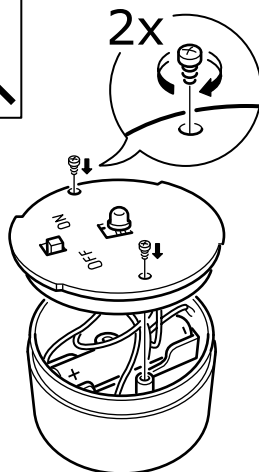
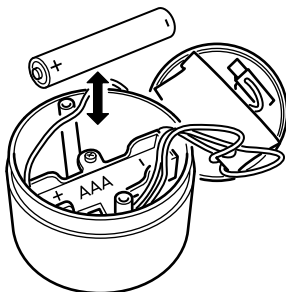
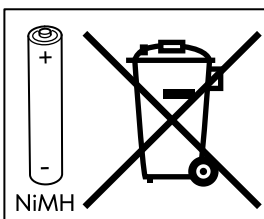
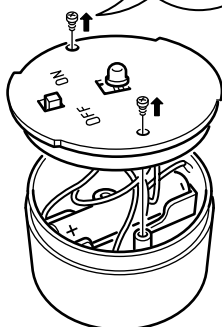

LIETUVIŲ

Po apytiksliai dvejų metų, kai šviestuvas neįsijungs, įkraunamą bateriją reikės pakeisti nauja. Keiskite įkraunamomis Ni-MH, AAA tipo baterijomis (1,2 V, 750 mAh).

Šviesos diodų LED šviesos šaltinis yra nekeičiamas.

**IŠSAUGOKITE INSTRUKCIJAS TOLIMES-
NIAM NAUDOJIMUI.**

PORTUGUÊS

Decorridos cerca de 2 anos, a bateria recarregável tem de ser substituída quando o candeeiro deixar de acender. Substitua por pilhas tipo AAA recarregáveis Ni-MH 1.2V, 750mAh.

A fonte de luz é LED (Díodos Emissores de Luz), que não pode ser substituída pelo cliente.

**GUARDE ESTAS INSTRUÇÕES PARA RE-
FERÊNCIA FUTURA.**

ROMÂNĂ

După aproximativ 2 ani, este necesar să înlocuiеști bateria reîncărcabilă. Înlocuiеște cu baterii reîncărcabile Ni-MH 1,2V, 750mAh, AAA. Bec LED; acesta nu poate fi schimbat de către client.

PĂSTREAȘĂ INSTRUCȚIUNILE PENTRU A LE FOLOSI MAI TĂRZIU.

SLOVENSKY

Po približne 2 rokoch používania bude potrebné vymeniť nabíjateľnú batériu (ak lampa nebude svietiť). Nahrad'te nabíjacími NiMH batériami typu AAA, 1.2V, 750mAh. Svetelný zdroj je LED (luminescenčná dióda) a jeho výmenu nemôže uskutočniť zákazník.

TIETO INŠTRUKCIE USCHOVAJTE NA ĎALŠIE POUŽITIE.

БЪЛГАРСКИ

След около 2 години акумулаторните батерии трябва да бъдат подменени, когато лампата не светва. Подменете ги с Ni-MH акумулаторни батерии 1.2V, 750mAh, тип AAA. Светлинният източник е LED (светодиоди) - светодиодите не могат да се подменят от клиента.

ЗАПАЗЕТЕ ТЕЗИ ИНСТРУКЦИИ ЗА БЪДЕЩА СПРАВКА.

HRVATSKI

Nakon otprilice 2 godine, kad se lampa više ne bude mogla upaliti, punjivu je bateriju potrebno zamijeniti. Zamijeniti punjivim baterijama Ni-MH 1,2 V, 750 mAh, AAA.

Izvor svjetla je LED (Light Emitting Diodes) koji kupac ne može zamijeniti.

SAČUVATI OVE UPUTE ZA BUDUĆE POTREBE.

ΕΛΛΗΝΙΚΑ

Μετά από περίπου 2 χρόνια, η επαναφορτιζόμενη μπαταρία θα πρέπει να αντικατασταθεί όταν το φωτιστικό δεν θα ανάβει πια. Αντικαταστήστε με επαναφορτιζόμενες μπαταρίες Ni-MH 1.2V, 750mAh, τύπου AAA.

Ο λαμπτήρας είναι LED (Light Emitting Diodes) και δεν μπορεί να αντικατασταθεί από τον πελάτη.

ΦΥΛΑΞΤΕ ΑΥΤΕΣ ΤΙΣ ΟΔΗΓΙΕΣ ΓΙΑ ΜΕΛΛΟΝΤΙΚΗ ΧΡΗΣΗ.

РУССКИЙ

Приблизительно после 2 лет использования перезаряжаемые батарейки необходимо заменить, если светильник не работает. Используйте перезаряжаемые батарейки Ni-MH 1,2 В, 750 мА/час, AAA.

Потребитель не может самостоятельно заменить источник света – светодиод.

СОХРАНИТЕ ЭТУ ИНФОРМАЦИЮ ДЛЯ ДАЛЬНЕЙШЕГО ИСПОЛЬЗОВАНИЯ.



2x

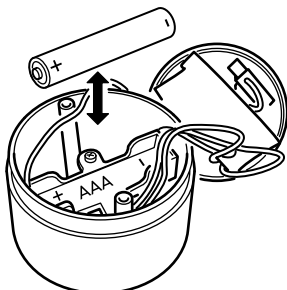
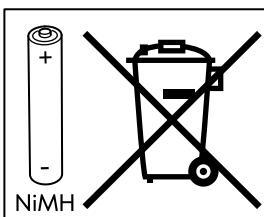
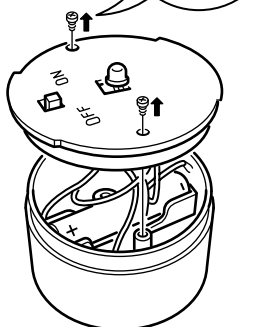

2x

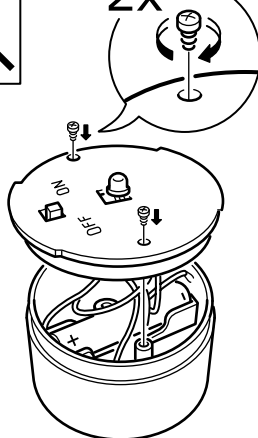

SRPSKI

Nakon oko 2 godine, ako lampa više neće da se uključi, treba zameniti punjive baterije. Zamenite ih Ni-MH punjivim 1.2V, 750mAh, AAA tipom baterija. Izvor svetlosti je LED (svetleće diode), koji kupac sam ne može da zameni.

SAČUVAJTE OVO UPUTSTVO ZA UBUDUĆE.

SLOVENŠČINA

Po približno 2 letih, ko se svetilka ne prižge več, je treba polnilno baterijo zamenjati. Uporabite Ni-MH polnilne baterije 1,2 V, 750 mAh, velikosti AAA. Svetlobni vir so LED (svetlobne) diode, ki jih ni mogoče zamenjati s strani kupca.

TA NAVODILA SHRANITE ZA NADALJNJO UPORABO.

TÜRKÇE

Şarj edilebilir pil, lamba yeteri kadar aydınlatmayacağından yaklaşık 2 yıl sonra değiştirilmelidir. Eski pili, Ni-MH şarj edilebilir 1.2V, 750mAh AAA tipi pil ile değiştiriniz. LED ampul (Işık Yayan Diyo- tlar), müşteri tarafından değiştirilemez.

GELECEKTE KULLANIM İÇİN BU TALİMATLARI SAKLAYINIZ.

中文

使用两年左右若灯具无法点亮则需更换充电电池。请更换 Ni-MH 1.2V, 750mAh, AAA 型充电电池。

光源为 LED，顾客请不要自行更换。

请保存此说明供日后参考。

繁中

使用約2年後·燈具無法亮起時·需更換充電電池。請更換4號鎳氫充電電池(1.2V, 750mAh, AAA) 燈具使用LED燈泡·不可更換燈泡。

請保留產品說明·以供參考。

한국어

약 2년 후 조명이 켜지지 않으면 충전지를 교체해 주세요. Ni-MH 충전식 1.2V, 750mAh, AAA 건 전지가 필요합니다. LED의 경우에는 고객이 자체적으로 교체할 수 없습니다.

나중을 위해 설명서를 보관해주세요.

日本語

電気がつかなくなった場合は、充電用電池を交換する必要があります（交換時期の目安は、使用開始後約2年です）。充電には、ニッケル水素充電電池（1.2V/750mAh/AAA）をお使いください。本製品の光源にはLEDを使用しています。LEDは交換できません。

この説明書は、いつでも参照できるように大切に保管してください。

BAHASA INDONESIA

Setelah kurang lebih 2 tahun, baterai yang dapat diisi ulang perlu diganti saat lampu tidak lagi menyala. Ganti dengan Ni-MH rechargeable 1.2V, 750mAh, tipe baterai AAA.

Bohlam adalah LED (Light Emitting Diodes), LED tidak dapat diganti oleh pelanggan.

SIMPAN PETUNJUK INI UNTUK PENGGUNAAN BERIKUTNYA.

BAHASA MALAYSIA

Selepas kira-kira 2 tahun, apabila lampu tidak menyala, bateri yang dicas semula perlu diganti. Gantikan dengan bateri yang boleh dicas jenis AAA, 750mAh 1.2V.

Sumber Cahaya ialah LED (Diod Pancaran Cahaya), LED tidak boleh ditukar ganti oleh pelanggan.

SIMPAN ARAHAN INI UNTUK KEGUNAAN AKAN DATANG.



2x

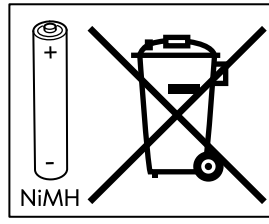
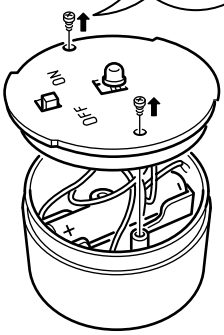

2x

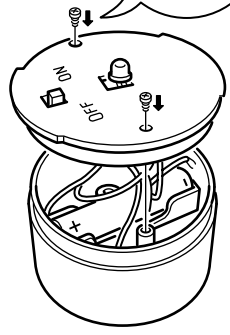
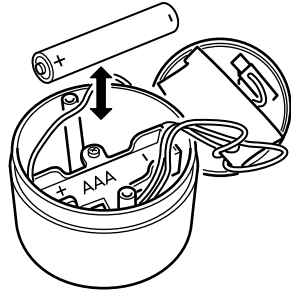

عربي

بعد سنتين تقريباً، تحتاج البطارية القابلة للشحن إلى استبدال عندما لا تضيء اللمبة. استبدلي بطاريات قابلة للشحن من نوعية Ni-MH 1.2V, 750mAh, AAA. مصدر الضوء LED ويعني) الدايمودات الباعثة للضوء(، لمبات LED لا يمكن للعميل أن يستبدلها.

يرجى حفظ هذه التعليمات لاستخدامها في المستقبل.

ไทย

หลังจากใช้งานนานประมาณ 2 ปี ควรเปลี่ยนแบตเตอรี่แบบชาร์จไฟได้ เมื่อไฟไม่ติด โดยเปลี่ยนด้วยแบตเตอรี่แบบชาร์จไฟได้ Ni-MH 1.2V, 750mAh ขนาด AAA หลอดไฟที่ใช้คือ หลอดไฟ LED (Light Emitting Diodes) ซึ่งไม่สามารถเปลี่ยนคืนได้

เก็บคำแนะนำนี้ไว้ในเผื่อกรณีจำเป็น

