

SPRIDD

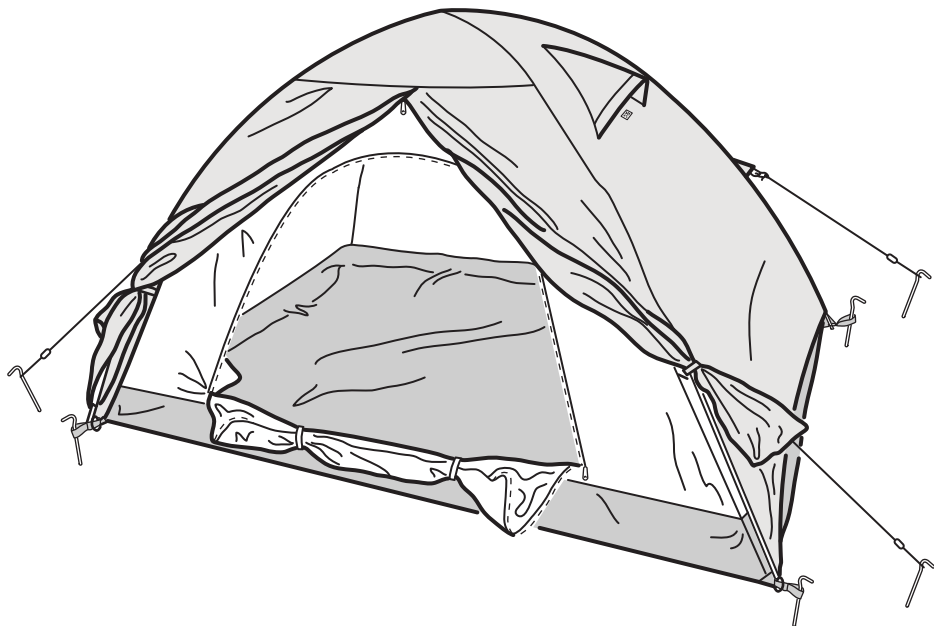

Design and Quality
IKEA of Sweden



GB WARNING!
KEEP AWAY FROM FIRE.

FR ATTENTION!
TENIR ÉLOIGNÉ DES
FLAMMES.

ES ¡ATENCIÓN!
MANTENER ALEJADO DEL
FUEGO.

DE ACHTUNG!
VON OFFENEM FEUER
FERNHALTEN.

NL WAARSCHUWING!
VERWIJDERD HOUDEN VAN OPEN
VUUR.

DK ADVARSEL!
SKAL HOLDES BORTE FRA ÅBEN
ILD.

NO ADVARSEL!
HOLDES UNNA ÅPEN ILD.

FI VAROITUS!
PIDETTÄVÄ KAUKANA
AVOTULESTA.

SE VARNING!
FÅR EJ KOMMA NÄRA ÖPPEN
LÅGA.

IS VARÚÐ!
HALDIð FJARRI OPNUM ELDI

CZ UPOZORNĚNÍ!
UMÍSTĚTE DALEKO OD OHNĚ.

IT AVVERTENZA!
TENERE LONTANO DAL FUOCO.

HU FIGYELEM!
TÚZTÓL TÁVOL KELL TARTANI.

PL OSTRZEŻENIE!
TRZYMAĆ Z DALA OD OGNIA.

ET HOIATUS!
HOIDKE TULEKOLDEST EEMAL.

LV BRĪDINĀJUMS!

**SARGĀT NO UGUNŠ
LT ĮSPĖJIMAS!**
SAUGOKITE NUO UGNIES.

PT ATENÇÃO!
MANTER AFÁSTADO DO FOGO.

RO ATENȚIE!
NU LĂSA ÎN ÎNPROPIEREA
SURSELOR DE FOC.

SK VAROVANIE!
DRŽTE MIMO DOSAHU OHŇA.

BG ВНИМАНИЕ!
ДРЪЖТЕ ДАЛЕЧЕ ОТ ОГЪН.

HR UPOZORENJE!
DRŽITE DALJE OD VATRE.

GR ΠΡΟΕΙΔΟΠΟΙΗΣΗ!
ΚΡΑΤΗΣΤΕ ΤΟ ΜΑΚΡΥΑ ΑΠΟ
ΦΩΤΙΑ.

RU ВНИМАНИЕ!
БЕРЕЧЬ ОТ ОГНЯ.

RS UPOZORENJE!
DRŽITE DALJE OD VATRE!

SI OPOZORILO!
HRANITE STRAN OD OGNJA.

TR UYARI!
ATEŞTEN UZAK TUTUNUZ.

中文 警告!
须远离火源。

藏语 警告!
遠離火源。

KR 경고!
화기에 가까이 두지 마세요.

JP 警告!
火気の近くでは使用しないでください。

ID PERINGATAN!
JAUHKAN DARI API

BM AMARAN!
JAUHKAN DARIPADA API.

AR تحذير!
إحفظ بعيداً عن النار.

TH คำเตือน
เก็บให้ห่างจากเปลวไฟ

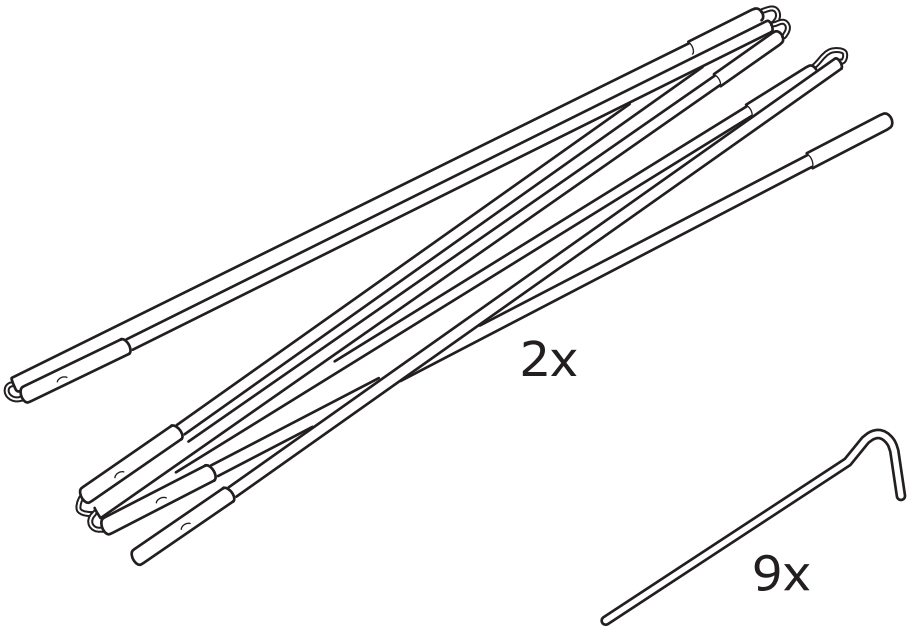
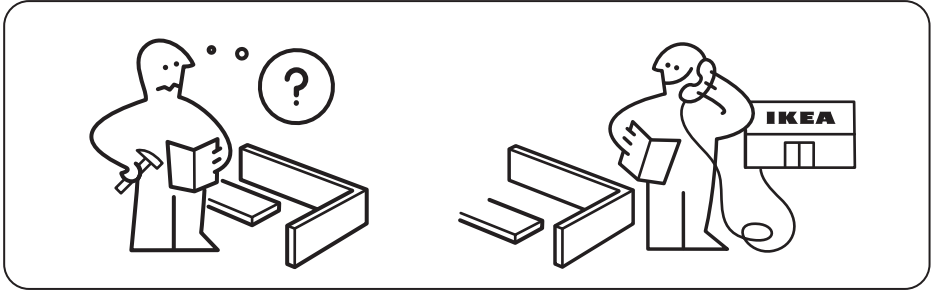
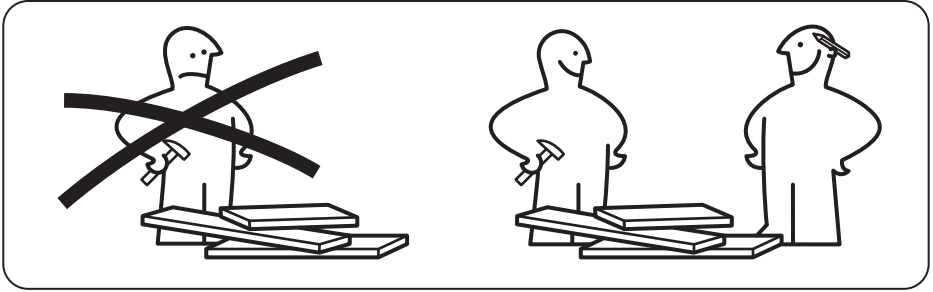

1

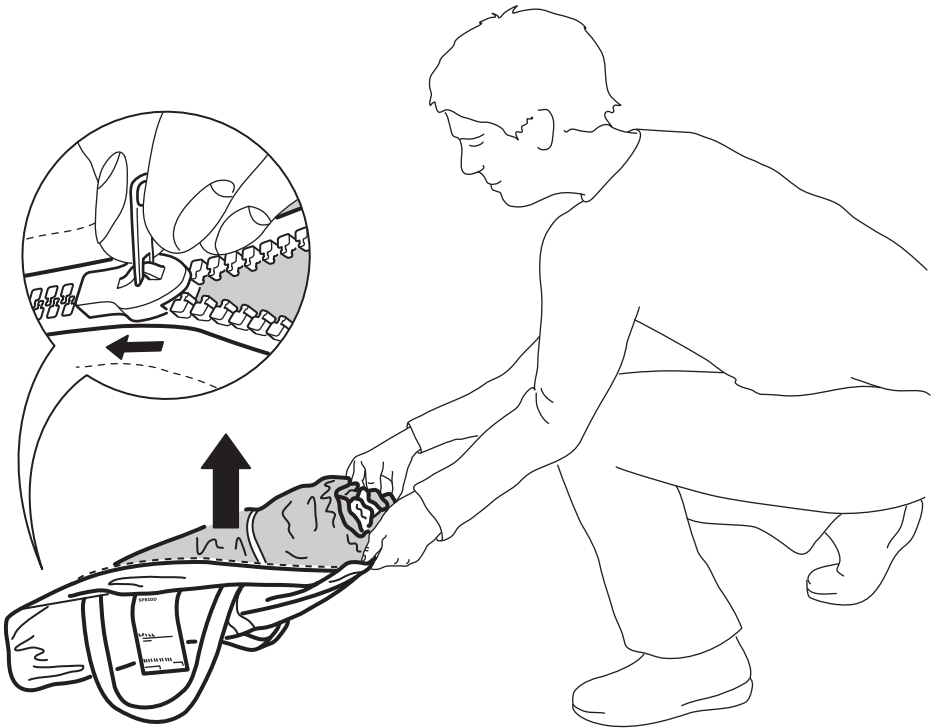

2

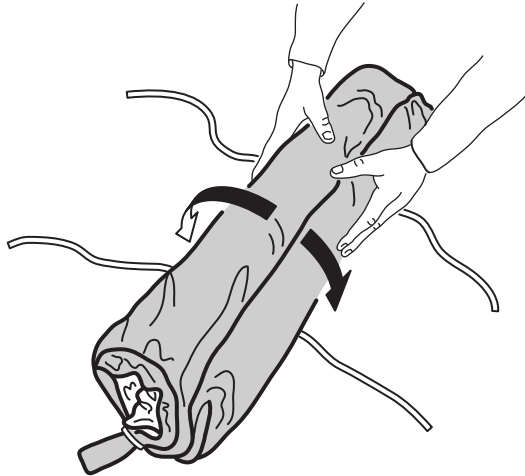
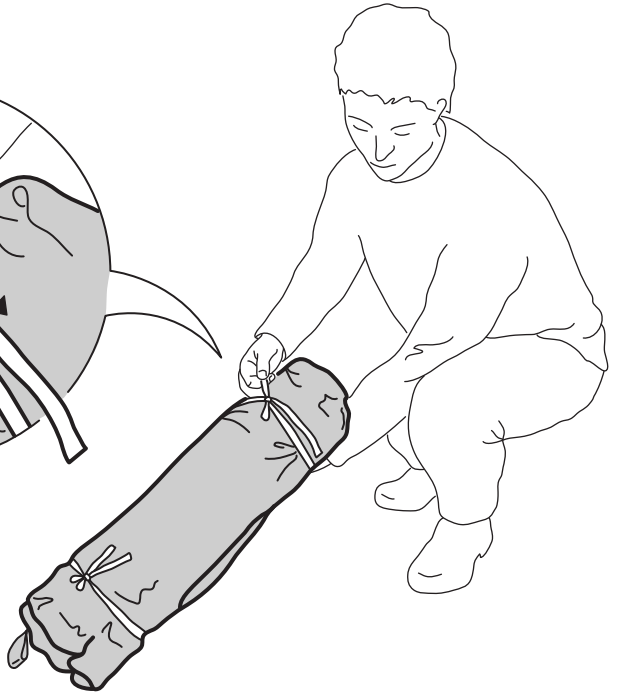
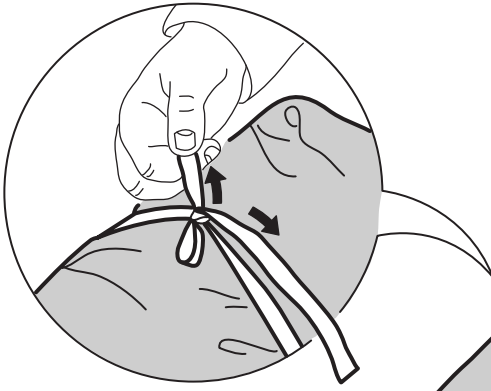

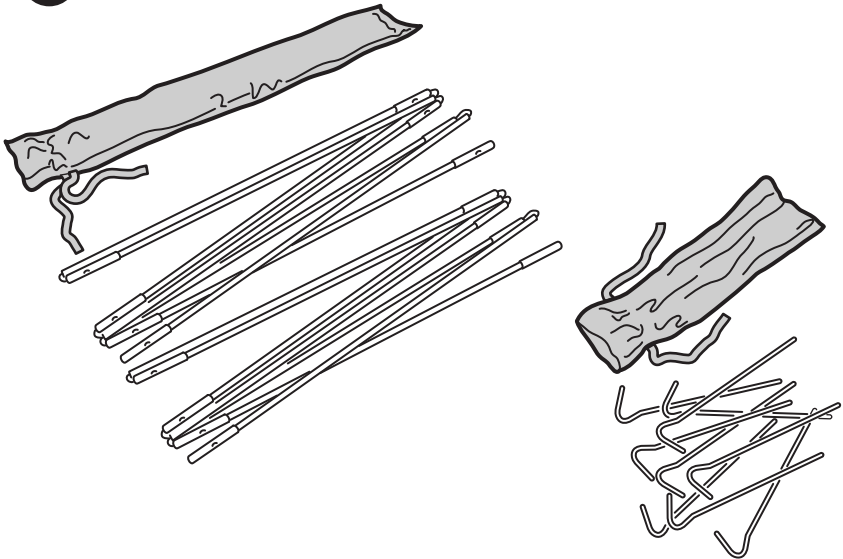
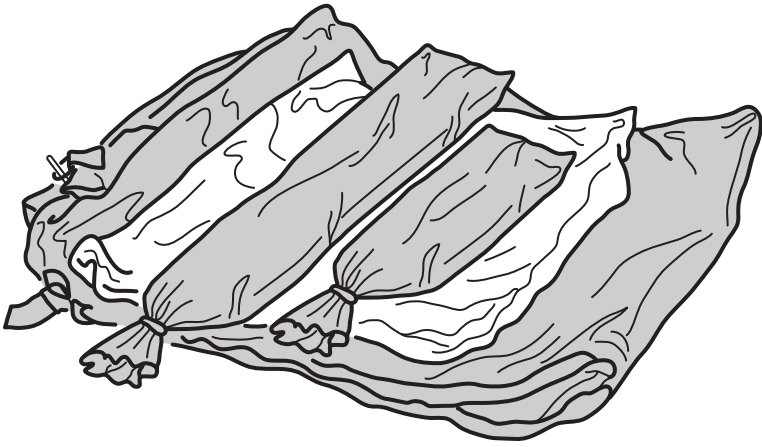

3

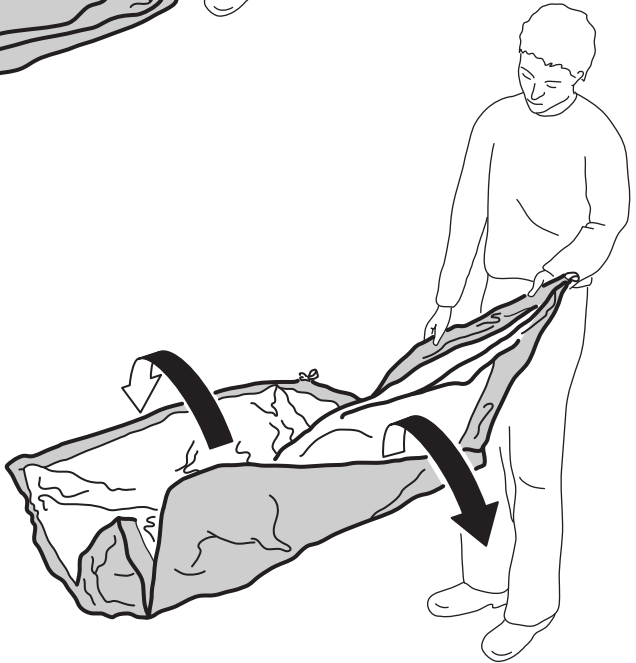

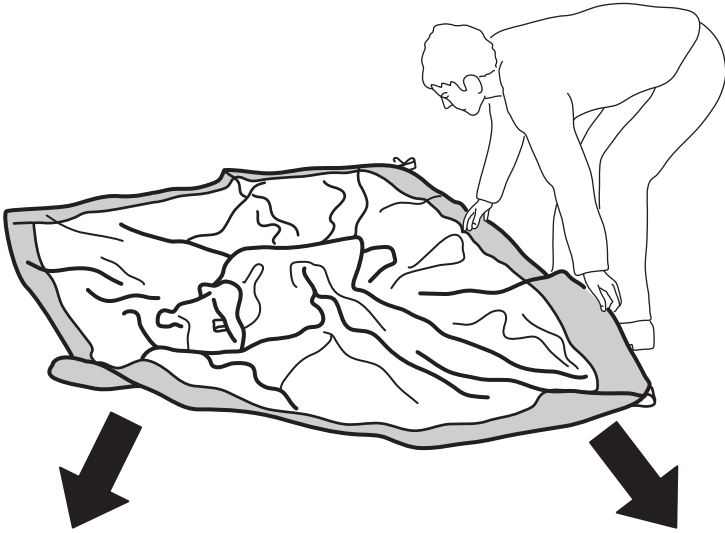

4

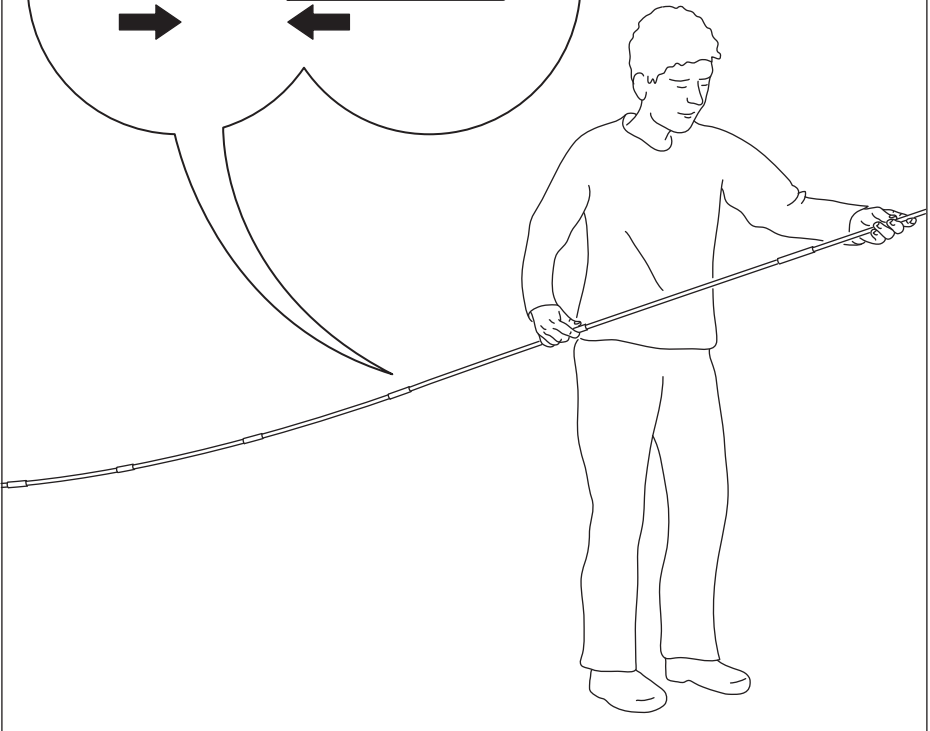
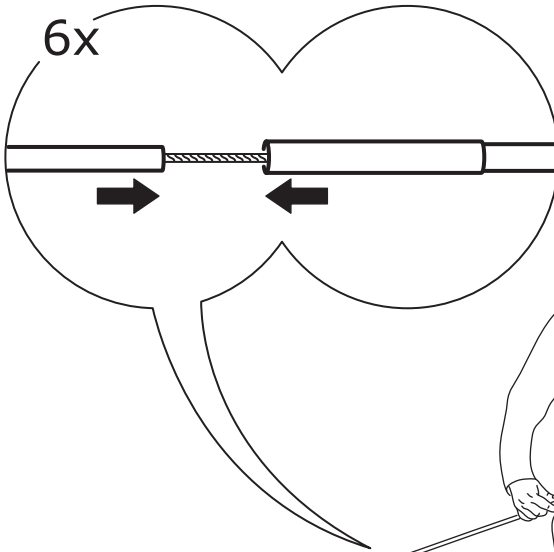
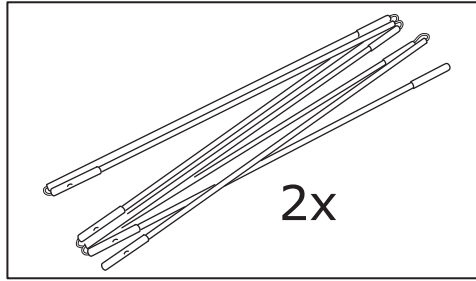

5

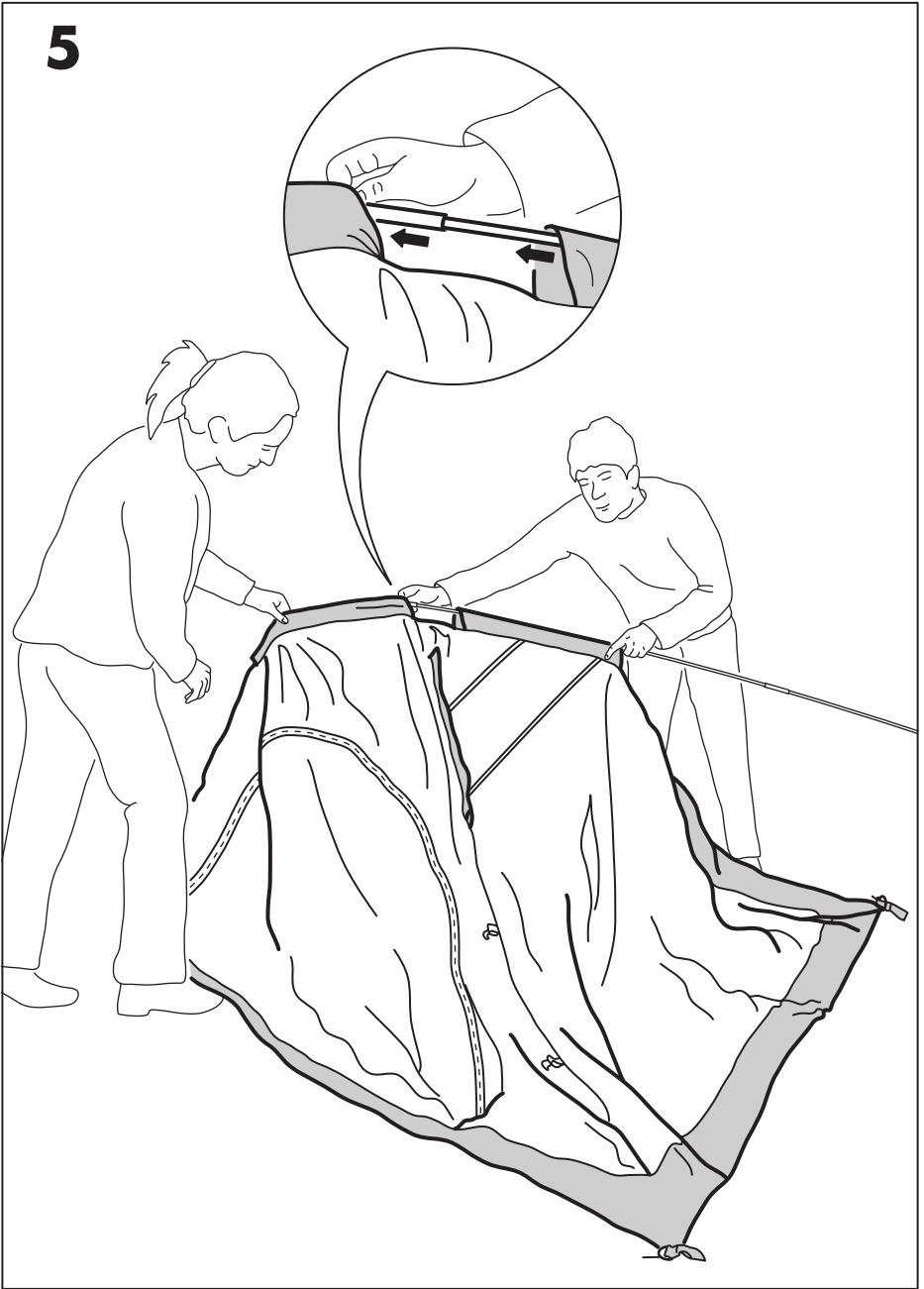

6

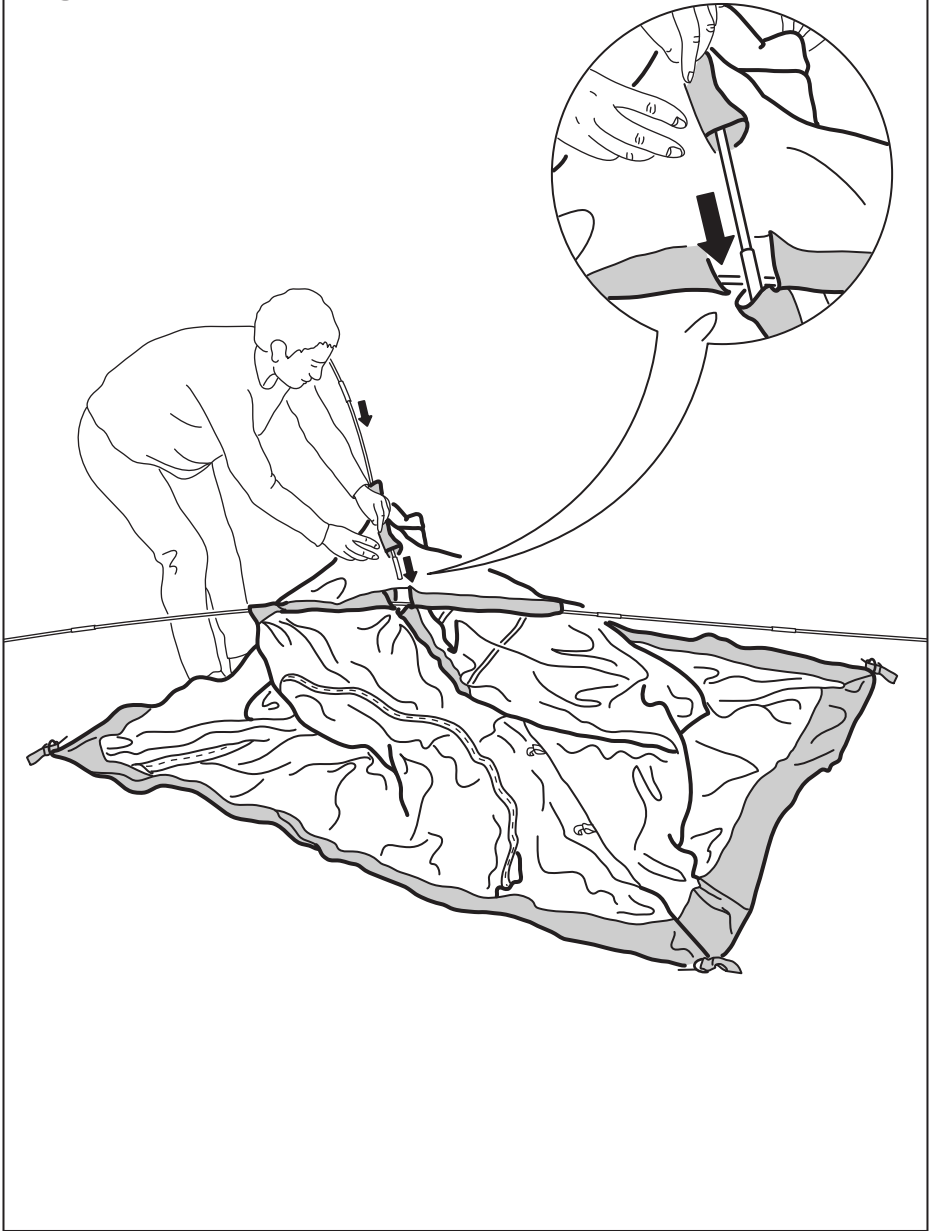

7

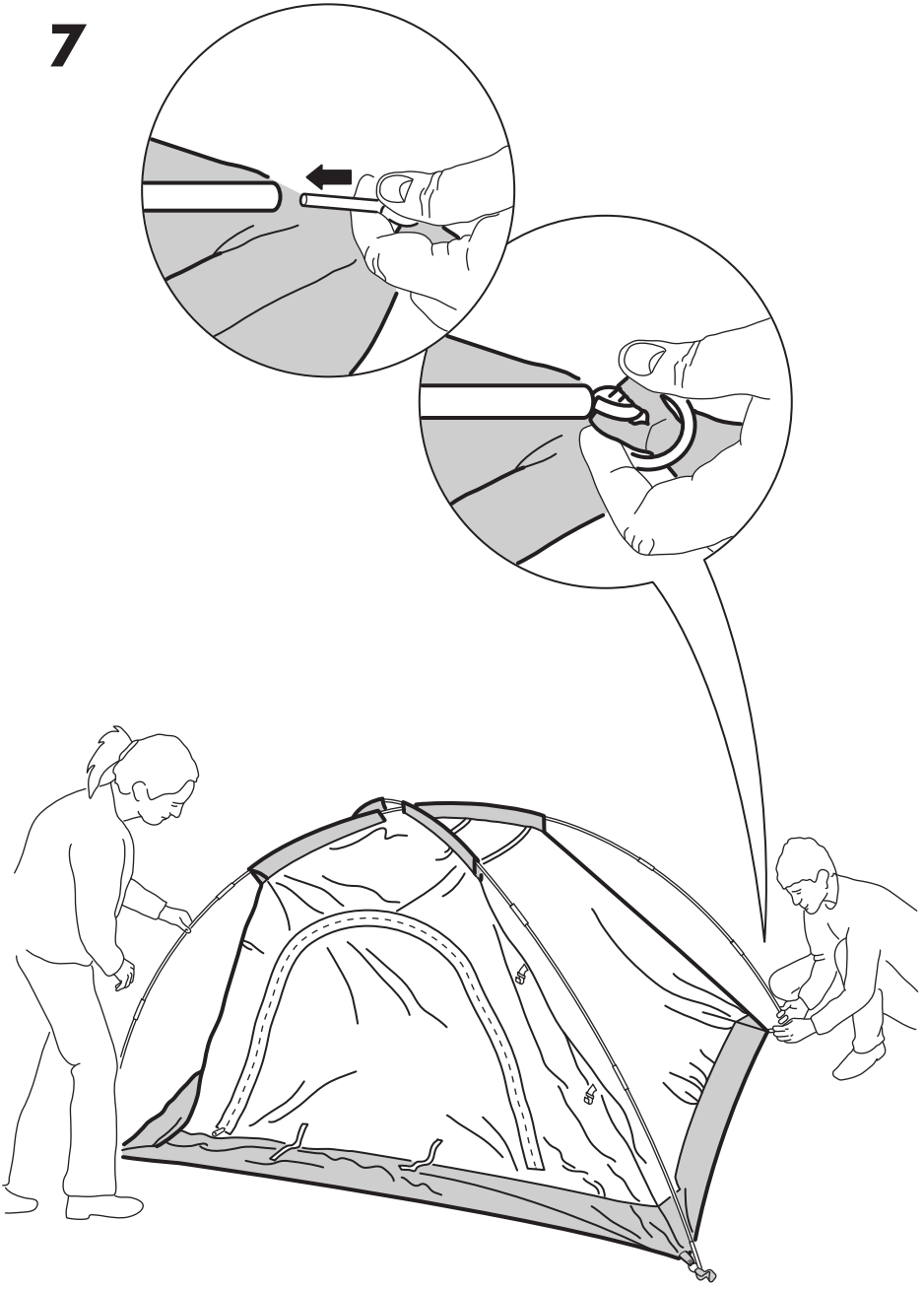

8

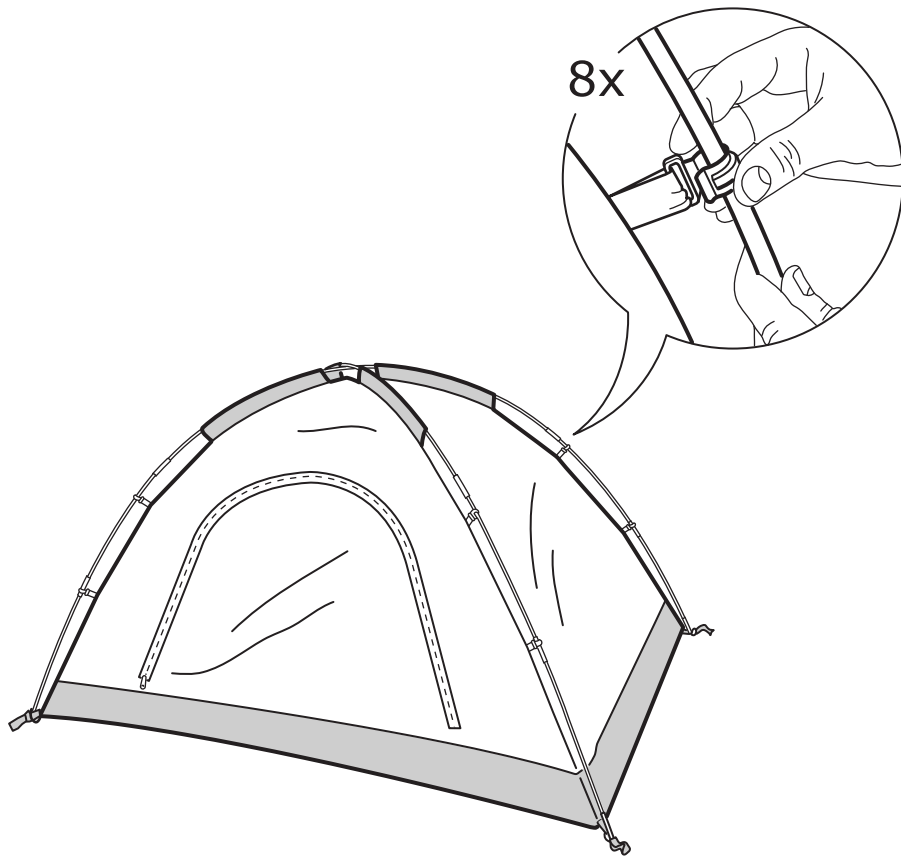

9

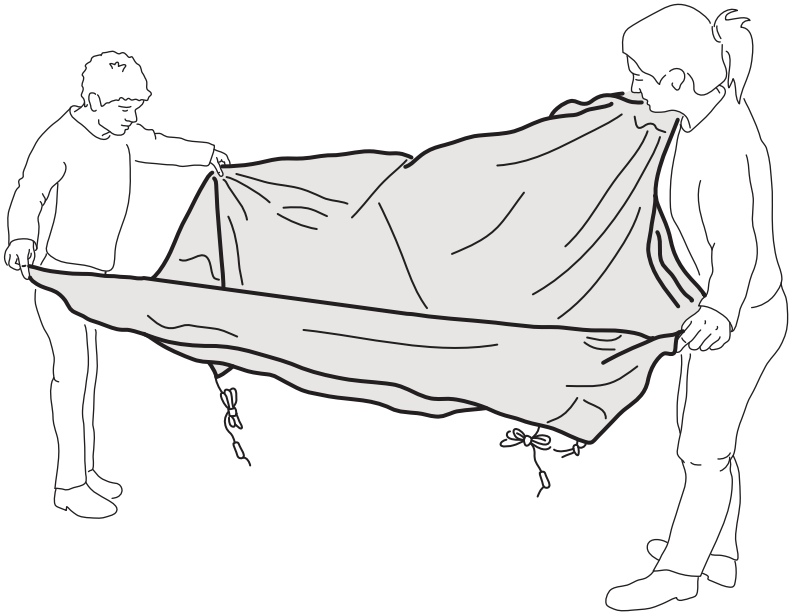
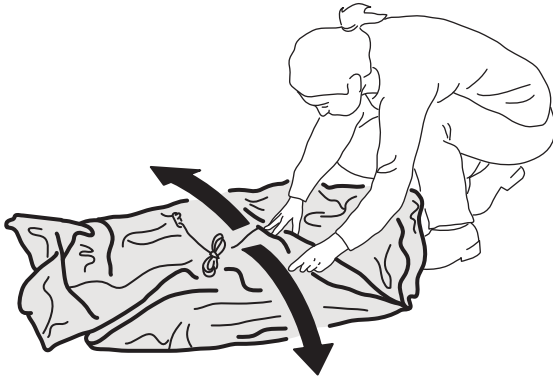

10



11

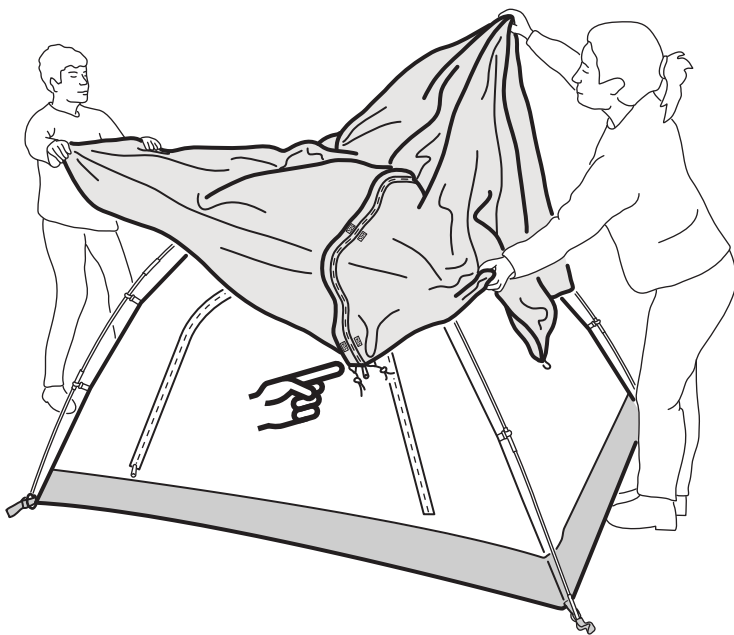

12

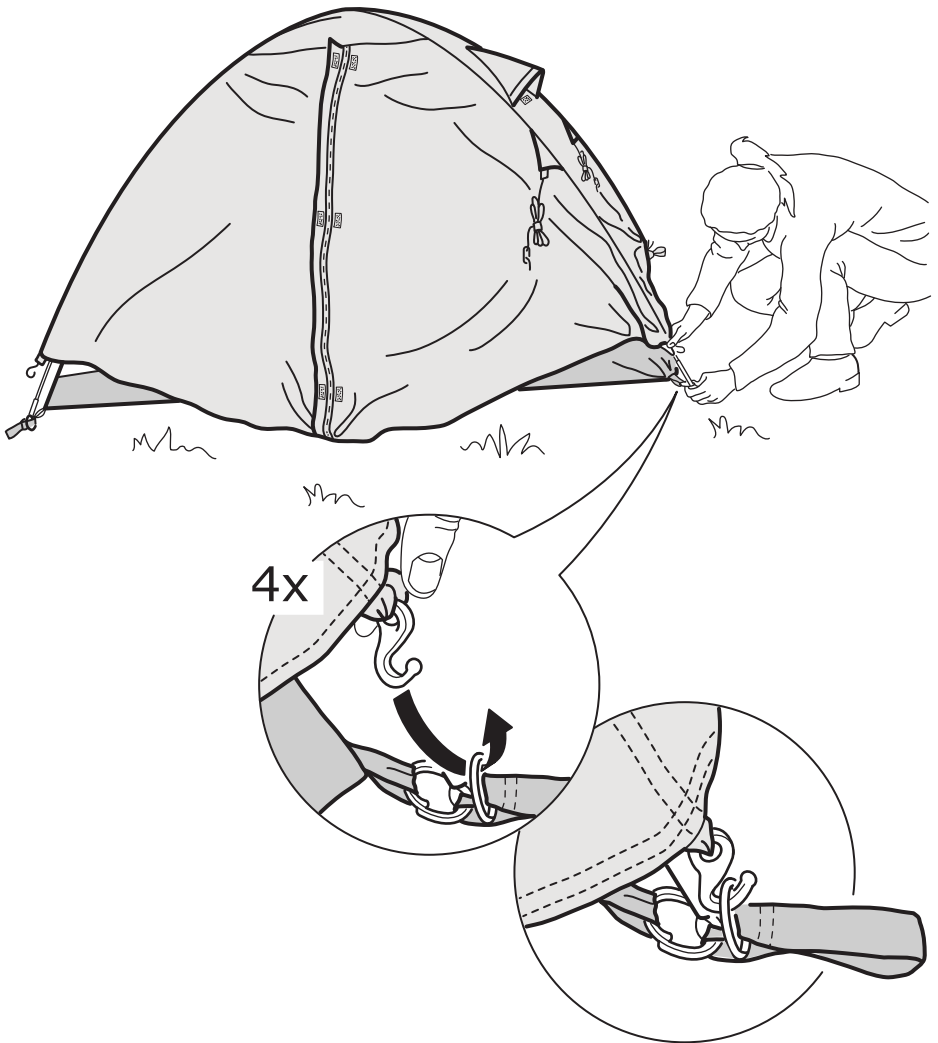

13

4x

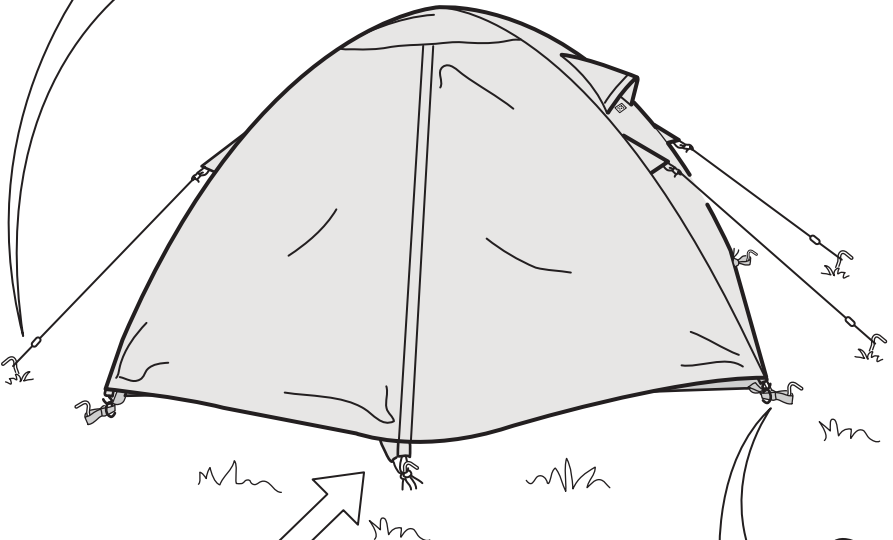
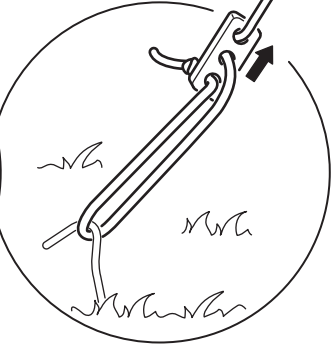
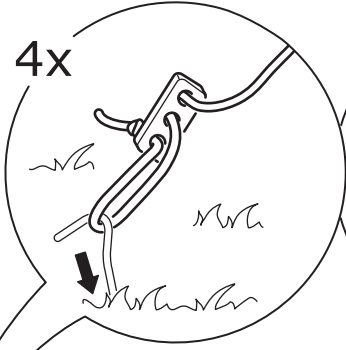

i

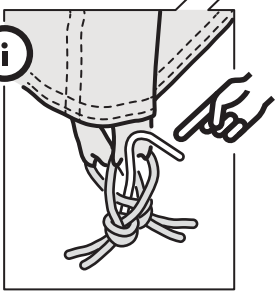

5x

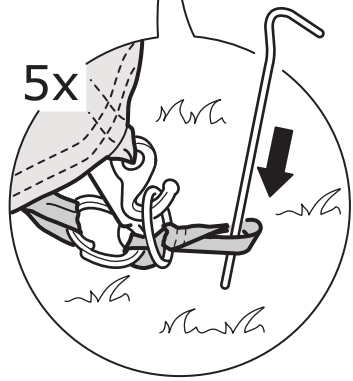

14



15

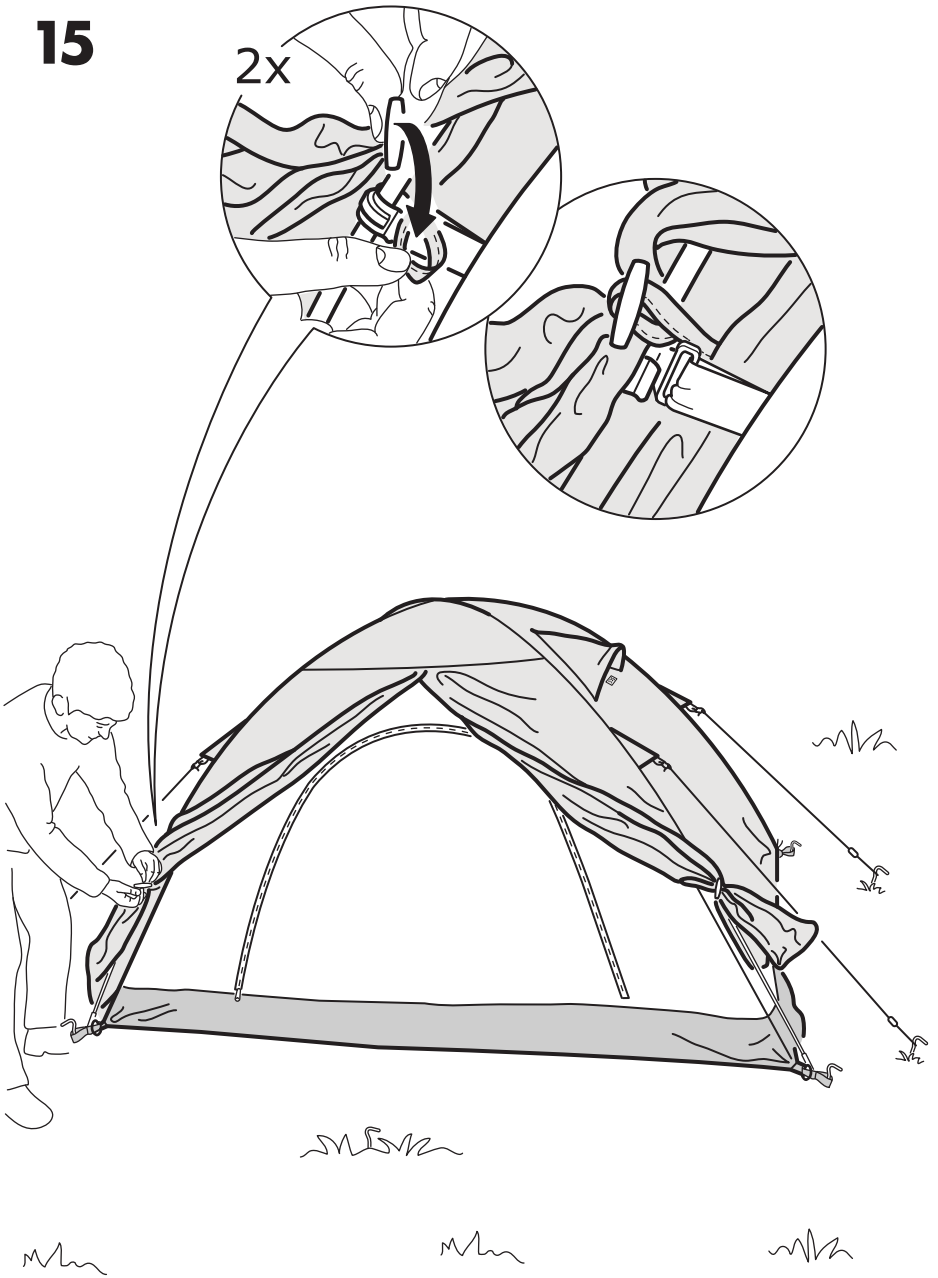

16

