

# STOLMEN

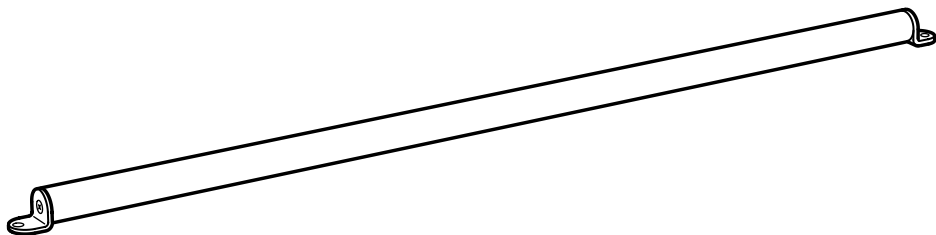

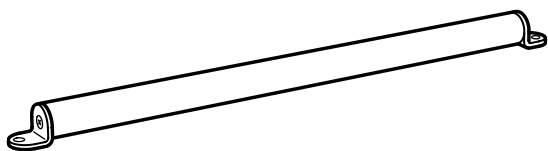
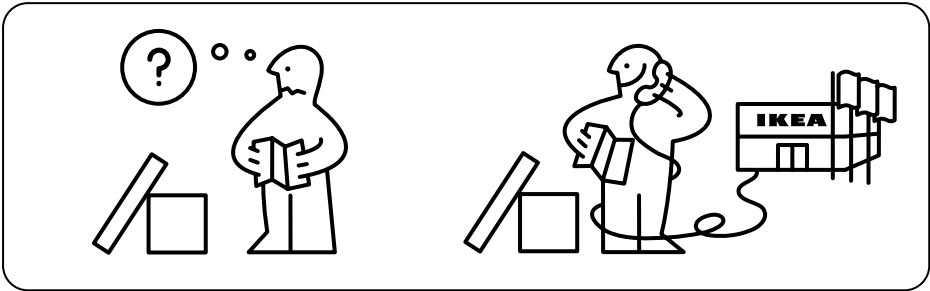
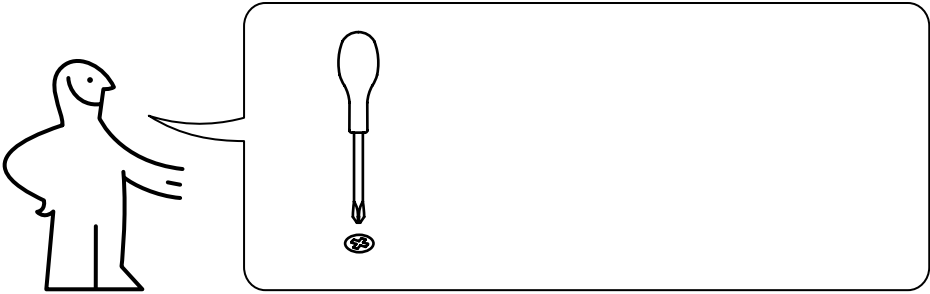

101082

2x

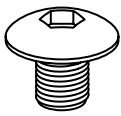

111058

2x

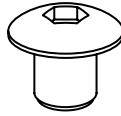

111059

2x

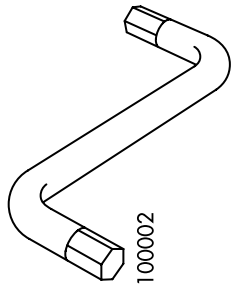

100002

1x

1

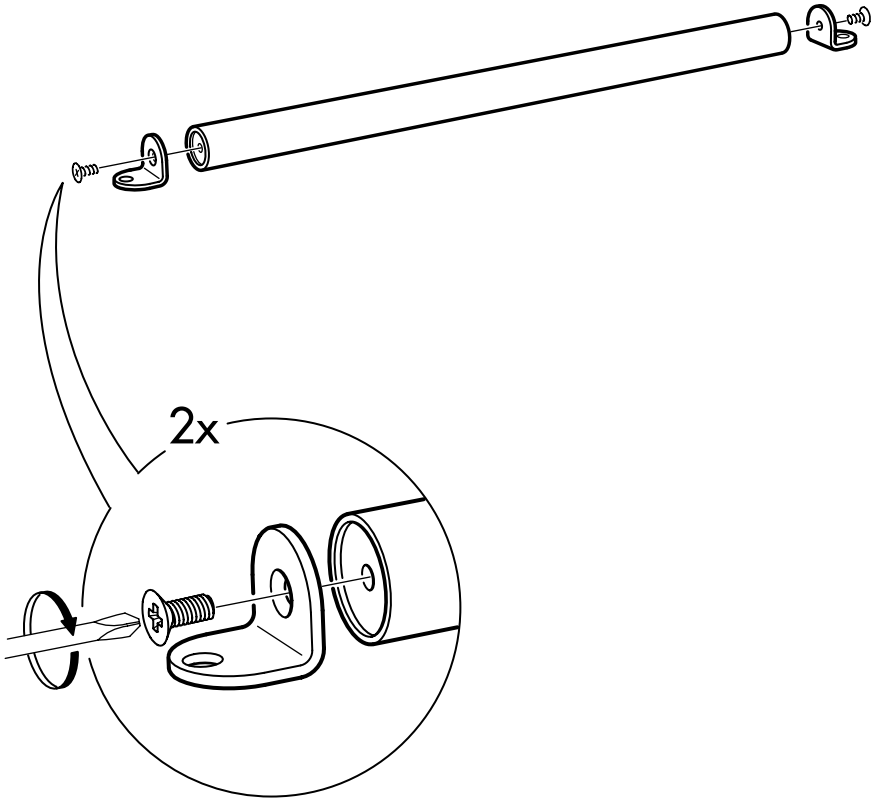

# 2

