

TRÅDFRI

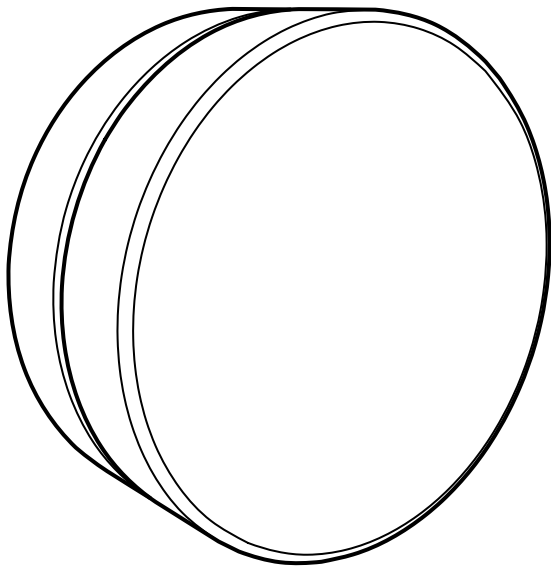

Design and Quality
IKEA of Sweden



ENGLISH

Different materials require different types of fittings. Always choose screws and plugs that are specially suited to the material.

FRANÇAIS

Le choix des vis dépend du matériau dans lequel elles doivent être fixées. Utiliser des vis et chevilles adaptées au matériau du support.

ESPAÑOL

Diferentes materiales requieren diferentes clases de herrajes. Recuerda que los tornillos y tacos que elijas se deben adaptar al material en el que irán sujetos.

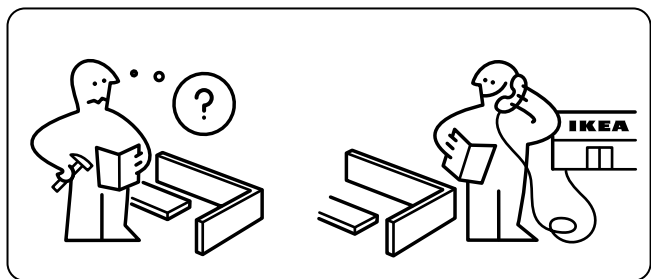
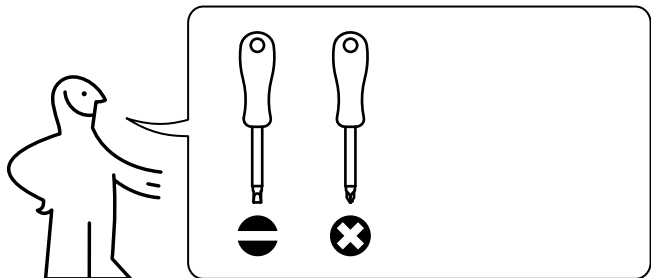

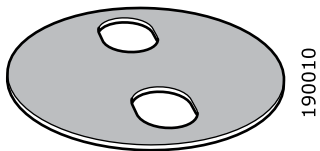

190010

1x

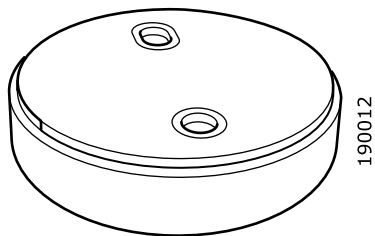

190012

1x

1

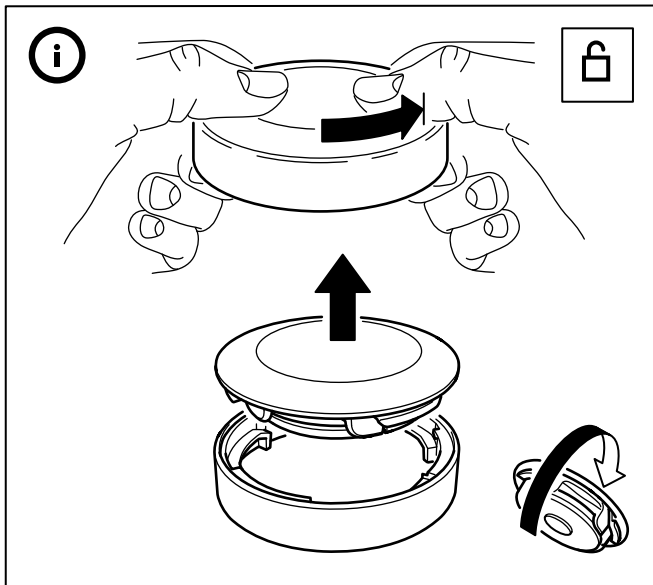
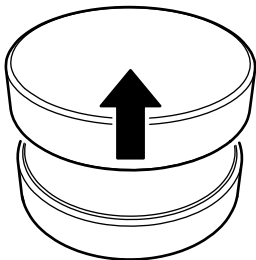

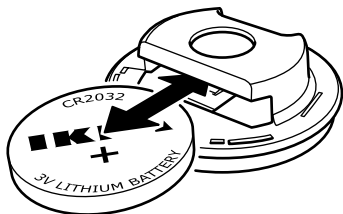
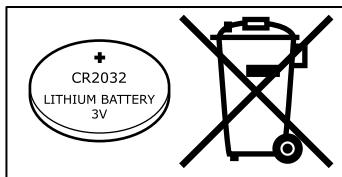
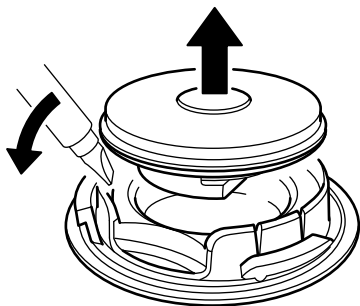

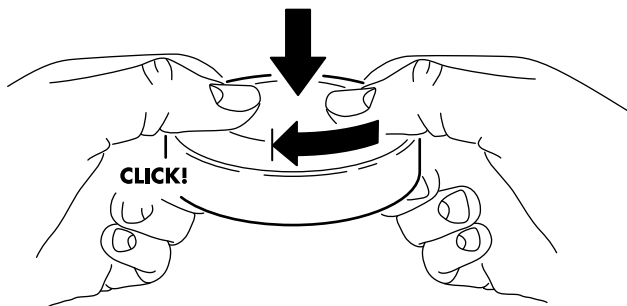
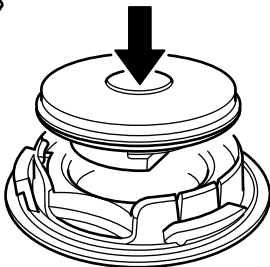



ENGLISH

Keep battery out of childrens reach. To swallow a battery could be fatal. If this happens seek medical attention at once. Before disposal always cover the battery in plastic tape to avoid possible short circuit.

SAVE THESE INSTRUCTIONS

FRANÇAIS

Gardez la pile hors de portée des enfants. Avaler une pile peut être fatal. Si cela se produit, appelez immédiatement un médecin. Avant de mettre la pile au rebut, couvrez-la d'une bande plastique pour éviter tout court-circuit.

CONSERVER CES INSTRUCTIONS

ESPAÑOL

Mantén la pila fuera del alcance de los niños. Ingerir una pila podría ser fatal. En caso de que suceda, acude inmediatamente al médico. Antes de desecharla cubre la pila con plástico para evitar cortocircuitos.

GUARDA ESTAS INSTRUCCIONES

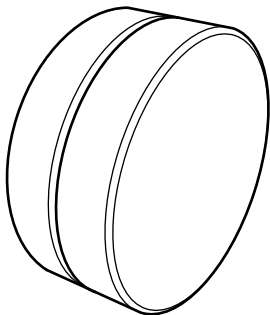

+

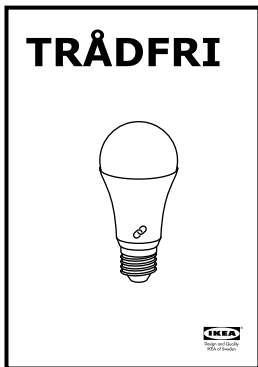

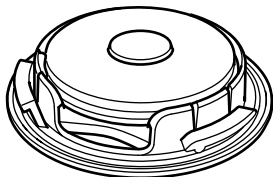
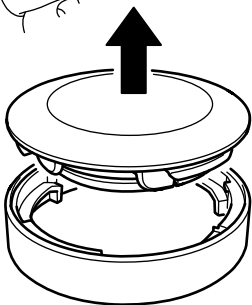
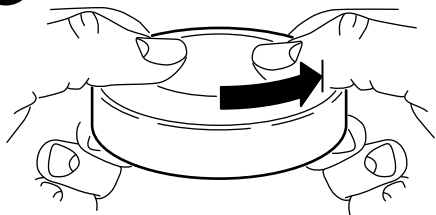

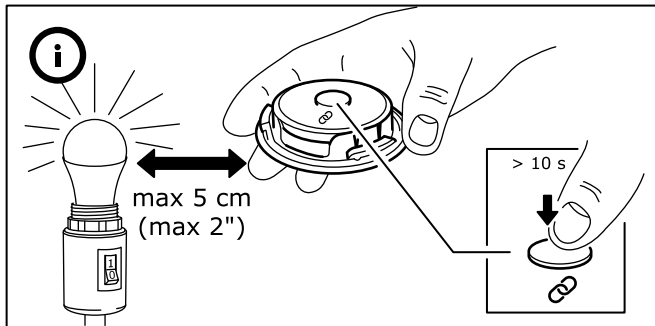
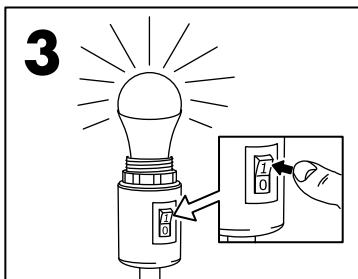
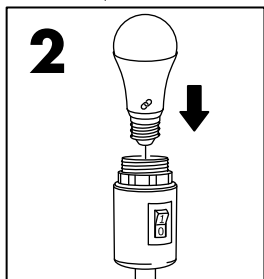

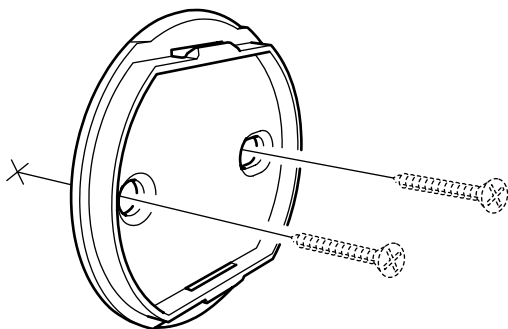
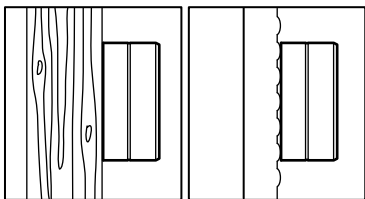

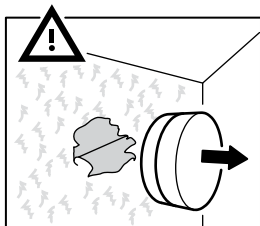
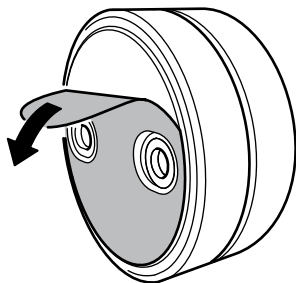
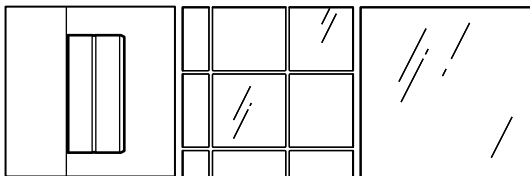

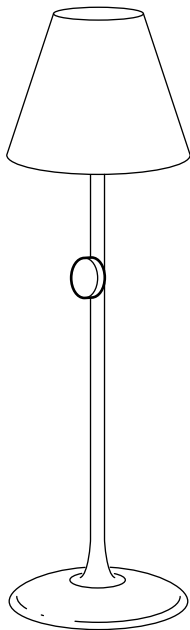
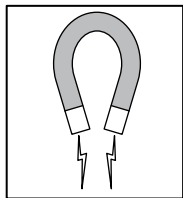
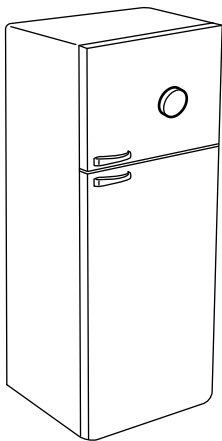

4

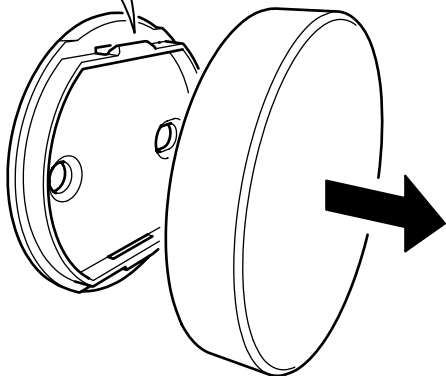
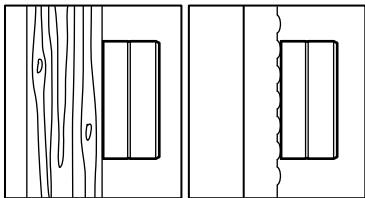
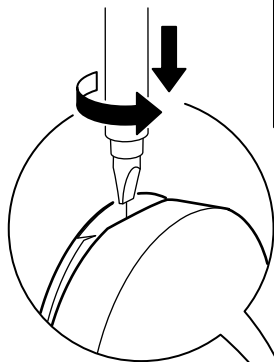

5

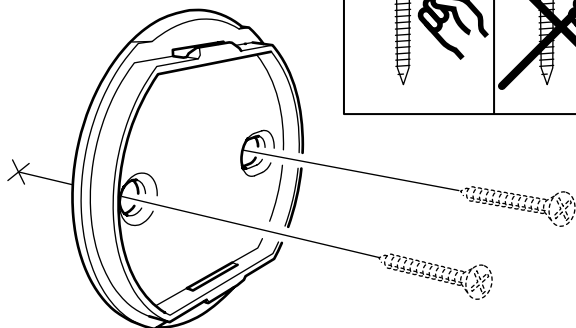
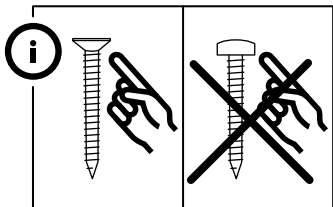

6

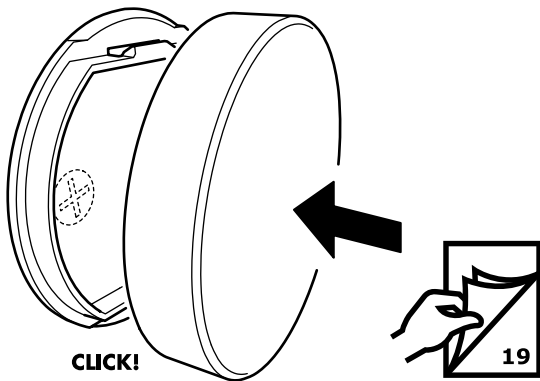

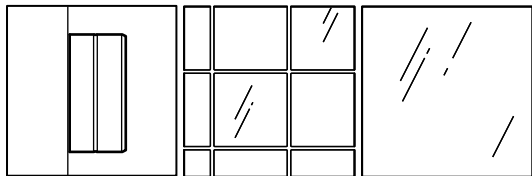

4

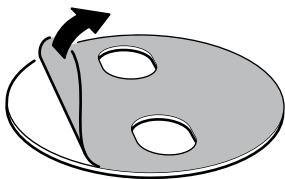

5

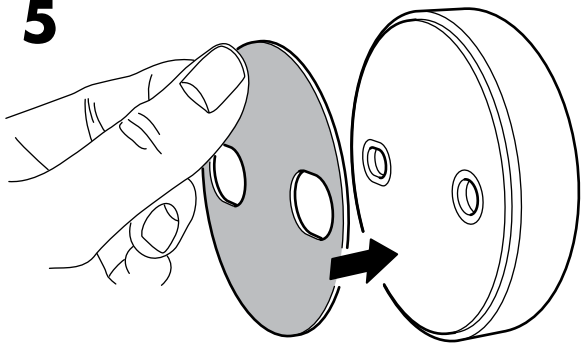

6

