

English

Wipe clean with a soft cloth dampened in water and a mild non-abrasive washing-up detergent or soap, if necessary. Wipe dry with a clean cloth.

How to handle your products with protective film

- Before assembly, remove protective film from edges and other surfaces which may interfere with assembly.
- Leave remaining protective film to avoid damage during assembly. After assembly, remove all protective film.
- Note – surfaces may be extra sensitive to scratches immediately after removing the protective film.
- To further improve resistance to scratches, wipe surfaces with a mild soap solution (max. 1%, no alcohol or abrasives).

Deutsch

Mit einem in Wasser angefeuchteten weichen Tuch und, wenn nötig, mit schleifmittelfreiem Reinigungsmittel oder Seifenlösung säubern. Mit einem sauberen Tuch abtrocknen.

Behandlung von Produkten mit Schutzfolie

- Vor der Montage die Schutzfolie von der Kante und anderen Oberflächen entfernen, wo sie bei der Montage störend sein könnte.
- Die übrige Schutzfolie am Produkt belassen, um Schäden beim Montieren zu vermeiden. Die Schutzfolie nach der Montage komplett entfernen.
- Bitte beachten - direkt nach Entfernen der Schutzfolie kann die Oberfläche besonders empfindlich gegen Kratzer sein.
- Zur Erhöhung der Strapazierfähigkeit die Oberfläche mit einem weichen Tuch und einer milden Seifenlauge (max. 1%; keine alkohohaltigen Mittel oder Schleifmittel) abwischen.

Français

Nettoyer à l'aide d'un chiffon doux imbibé d'eau et, si besoin, d'un détergent non abrasif ou de savon. Essuyer avec un chiffon propre.

Que faire du film protecteur sur les produits.

- Avant le montage, retirer le film de protection qui pourrait gêner, notamment au niveau des coins ou sur certaines surfaces.
- Laisser le film de de protection s'il ne gêne pas, afin d'éviter tout risque de dommages lors du montage. Après le montage, retirer tout le film protecteur.
- Attention : une fois le film retiré, la surface craint particulièrement les rayures.
- Pour renforcer la résistance à l'usure, nettoyer à l'aide d'un chiffon doux trempé dans de l'eau savonneuse (max. 1 % de détergent).

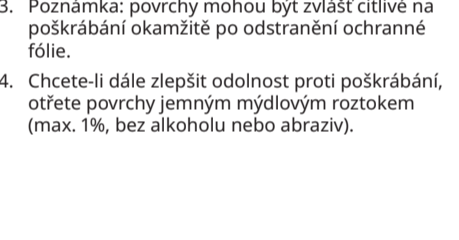
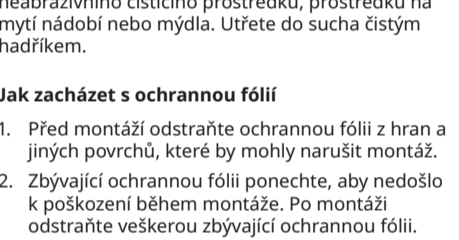
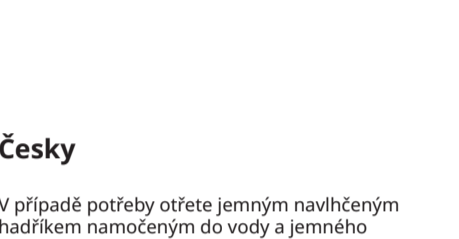

Nederlands

Schoonmaken met een vochtig doekje met water en evt. een schoonmaakmiddel zonder schuurmiddel, of een zeepoplossing. Nadrogen met een droge doek.

Omgaan met producten met beschermfolie

- Voor de montage: verwijder de beschermfolie van de randen en andere oppervlakken die de montage kunnen belemmeren.
- Laat de resterende beschermfolie zitten om beschadigingen tijdens de montage te voorkomen.
- Let op - oppervlakken kunnen meteen nadat de beschermfolie verwijderd is extra gevoelig zijn voor krassen.
- Om de slijtvastheid nog verder te verbeteren, de oppervlakken afnemen met een milde zeepoplossing (max. 1%, geen alcohol of schuurmiddel).

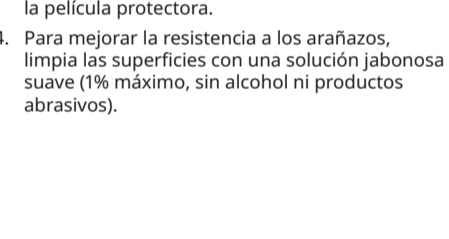
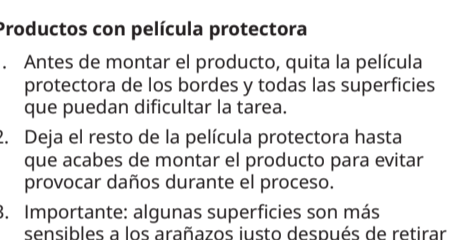
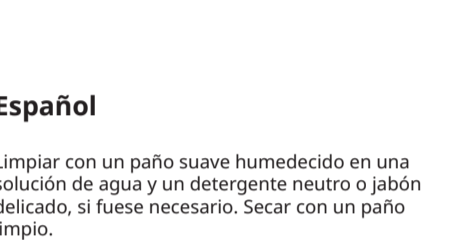

Dansk

Tørres eventuelt af med en blød, fugtig klud tilsat et mildt, ikke-slibende opvaskemiddel eller sæbe. Tør efter med en ren, tør klud.

Sådan håndterer du produkter med beskyttelsesfilm

- Før du samler produktet, skal du fjerne beskyttelsesfilmen fra kanter og andre overflader, der kan vanskeliggøre monterng.
- Lad beskyttelsesfilmen sidde de øvrige steder, så du ikke beskadiger produktet under monterng. Fjern al beskyttelsesfilm efter monterng.
- BEMÆRK!** Umiddelbart efter at du har fjernet beskyttelsesfilmen, kan overfladen være særligt modtagelig over for ridser.
- For at gøre overfladen stærkere, skal du tørre den af med en blød klud og en mild sæbeopløsning (maks. 1%, ingen alkohol eller slipemidler).

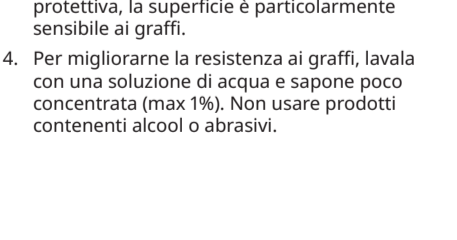
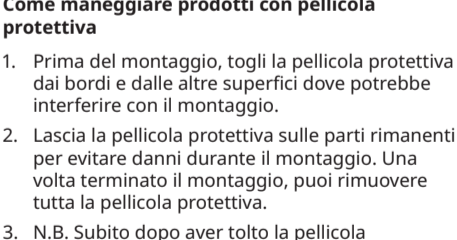
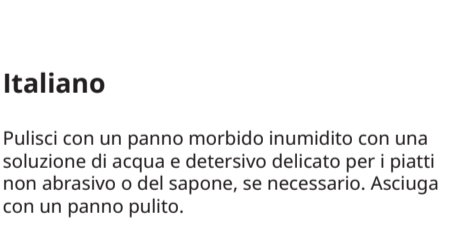
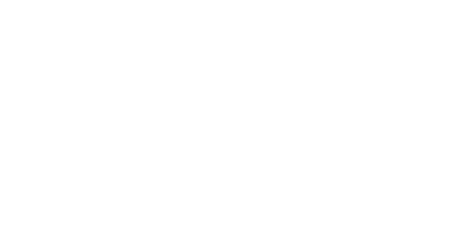

Íslenska

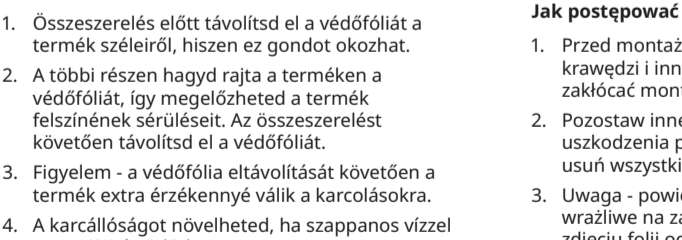
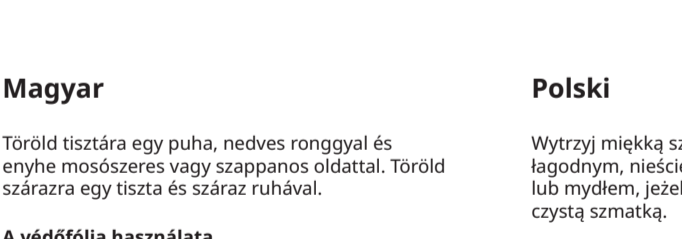
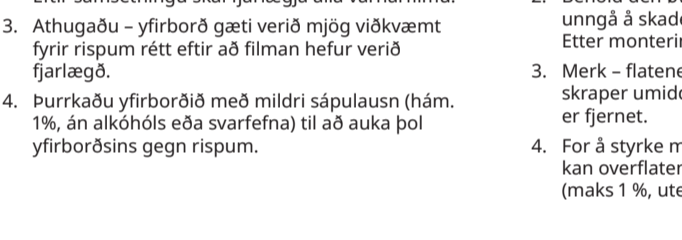
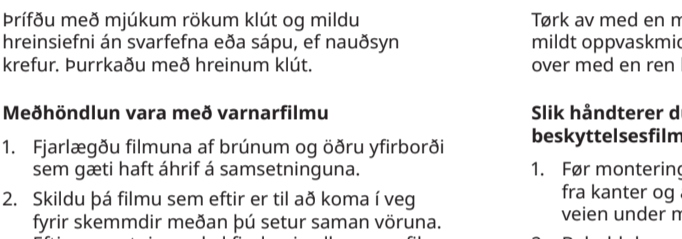

Norsk

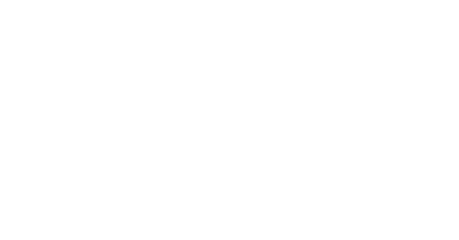
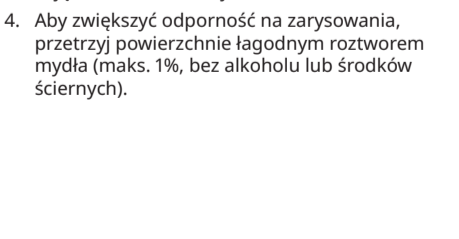
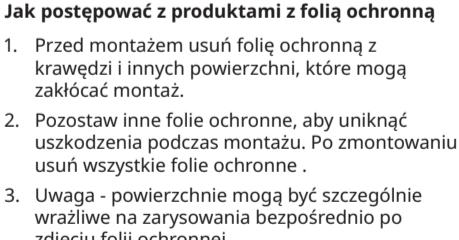
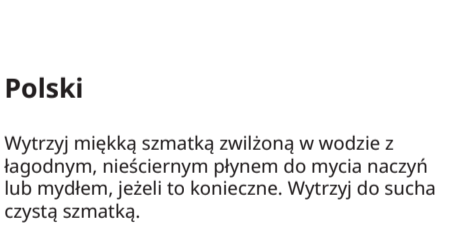
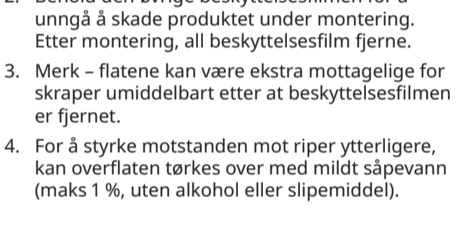
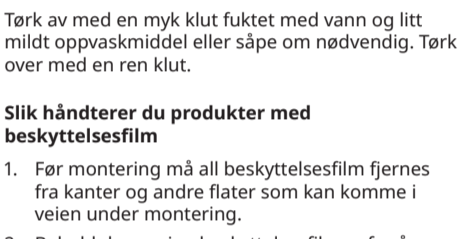

Suomi

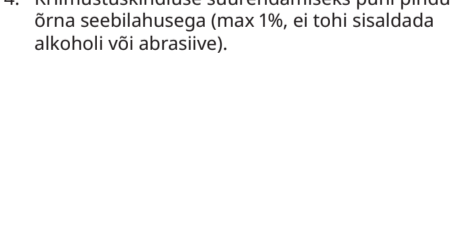
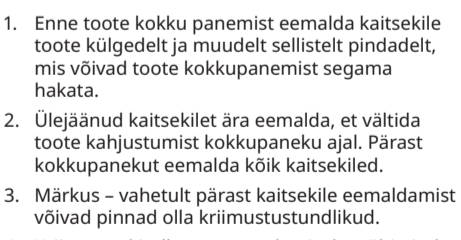
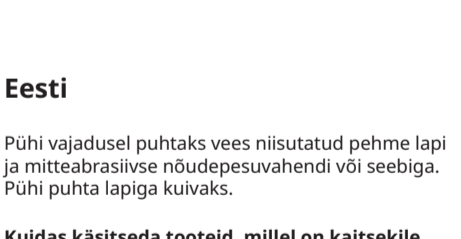
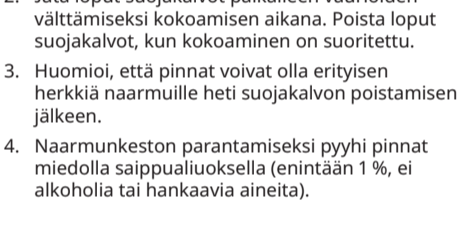
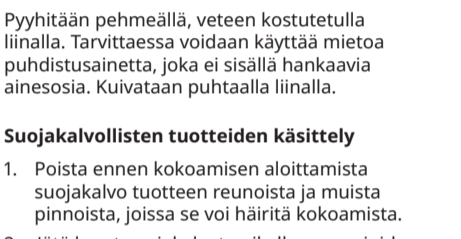

Svenska

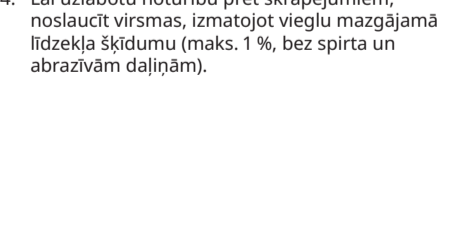
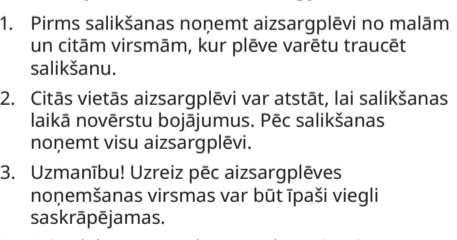
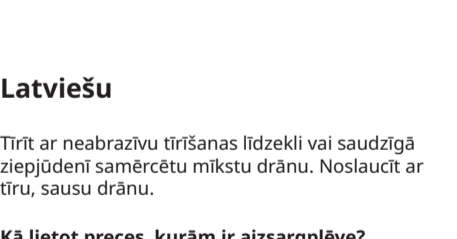
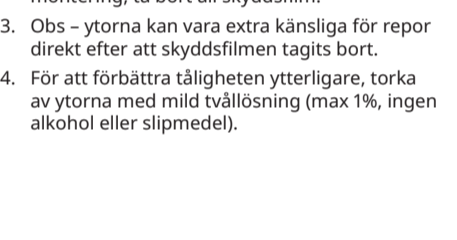
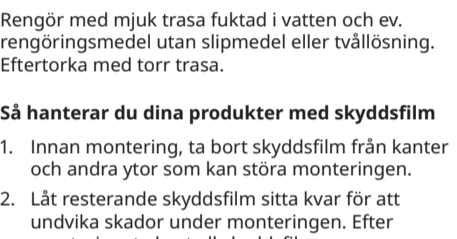

Česky

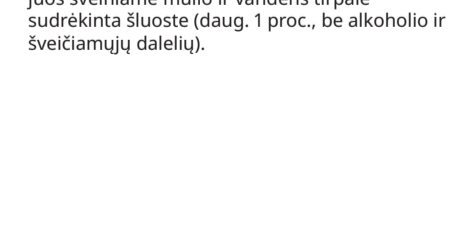
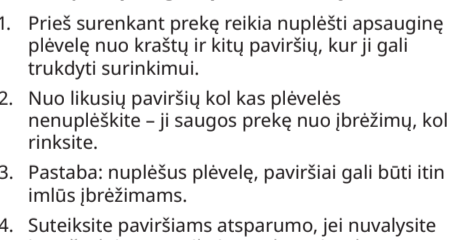
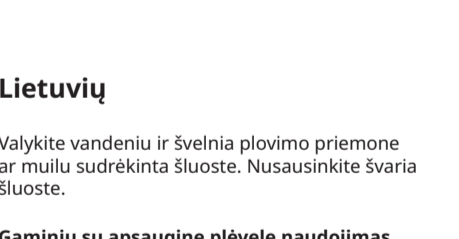
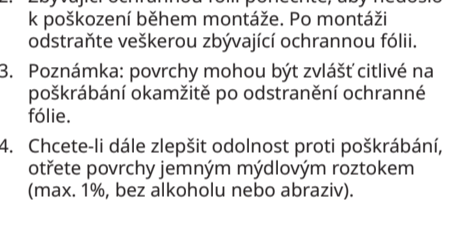
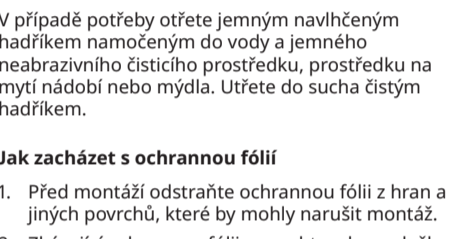

Español

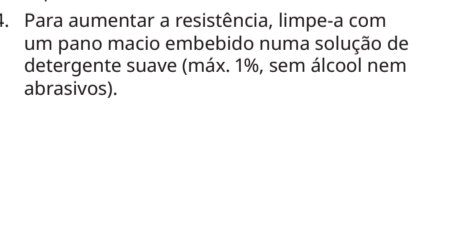
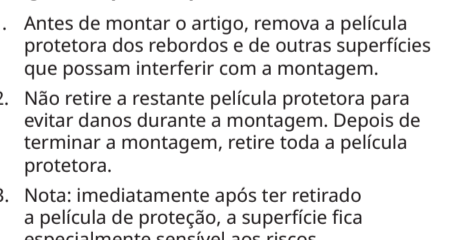
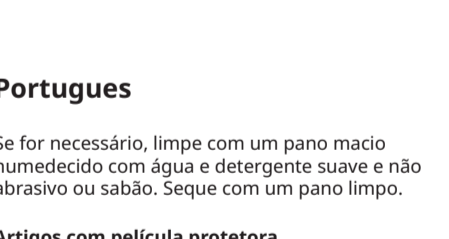
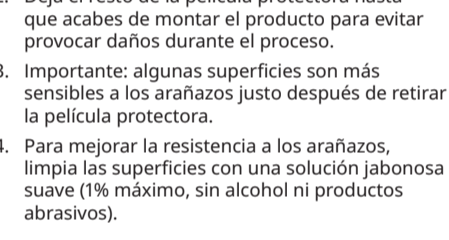
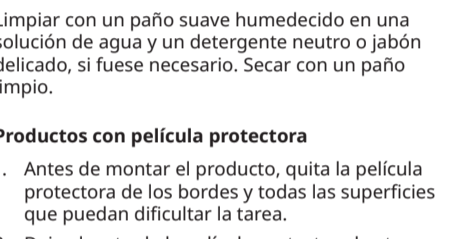

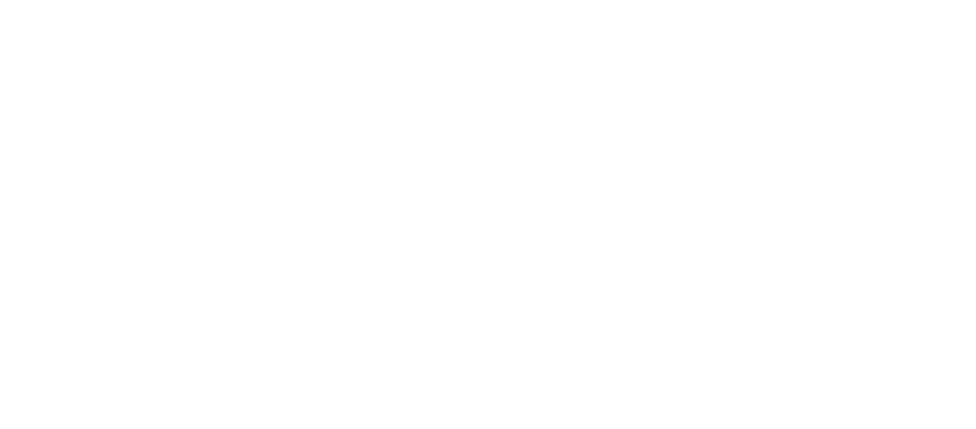
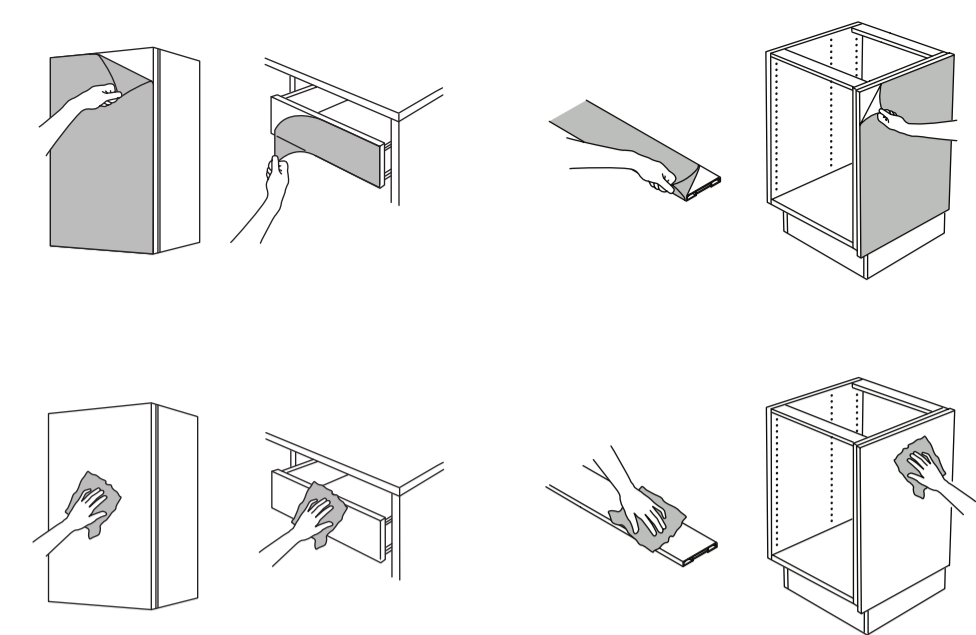

Русский

Протирать мягкой тканью, смоченной в воде с добавлением при необходимости мягкого неабразивного моющего средства или мыла. Затем вытирать чистой тканью.

Как обращаться с товарами с защитной пленкой

- Перед сборкой удалите защитную пленку с кромок и других поверхностей, где она может помешать сборке.
- Не удаляйте защитную пленку с других поверхностей, чтобы избежать повреждений при сборке. После сборки удалите всю защитную пленку.
- Внимание! Поверхности сразу после удаления защитной пленки могут быть очень чувствительны к царапинам .
- Для повышения устойчивости к царапинам протрите поверхности тканью, смоченной в слабом мыльном растворе (не более 1%, без спирта и абразивов).



한국어

부드러운 천을 물에 적신 뒤 비마모성 주방세제나 비누를 묻혀 닦아주세요. 깨끗한 천으로 물기를 닦아 마무리하세요.

보호 필름을 이용한 제품 취급

- 조립하기 전에 원활한 조립을 위해 모서리와 표면에 붙어 있는 보호 필름을 제거해 주세요.
- 다른 보호 필름은 조립 중 손상을 방지하기 위해 남겨주세요. 조립 후 모든 보호 필름을 제거하세요.
- 주의 - 보호 필름을 제거한 직후 표면이 긁힘에 매우 민감할 수 있습니다.
- 긁힘을 방지하기 위해 부드러운 비누 용액으로 표면을 닦아주세요. (최대 1%, 알코올이나 연마제가 없는 성분).

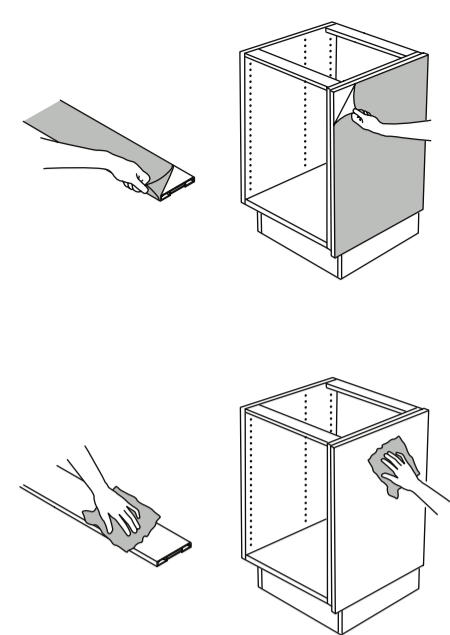

Româna

Curăța cu o cârpă înmuiată în apă și detergent delicat, neabraziv, sau săpun, dacă este necesar. Șterge cu o cârpă uscată.

Cum să folosești produse cu folie de protecție

- Înainte de asamblare, scoate folia de protecție de pe margini și alte suprafețe care pot interfera cu asamblarea.
- Lasă restul foliei de protecție pentru a evita deteriorarea în timpul asamblării. După asamblare, scoate toată folia de protecție.
- Notă - suprafețele pot fi foarte sensibile la zgârieturi imediat după eliminarea foliei de protecție.
- Pentru a îmbunătăți rezistența la zgârieturi, șterge suprafețele cu o soluție de detergent delicat (max. 1%, fără alcool sau substanțe abrazive).



Srpski

Čisti mekom krpom nakvašenom vodom i blagom neabrazivnom tečnošću za sude ili sapunom, po potrebi. Osuši čistom krpom.

Kako da rukuješ proizvodima sa zaštitnom folijom

- Pre sastavljanja, ukloni foliju s ivica i drugih površina koje mogu uticati na sastavljanje.
- Ostavi preostalu zaštitnu foliju da izbegneš oštećenja tokom sastavljanja. Po sastavljanju, ukloni zaštitnu foliju.
- Napomena — površine mogu biti posebno osetljive na ogrebotine neposredno posle uklanjanja zaštitne folije.
- Da dodatno poboljšaš otpornost na ogrebotine, prebriši površine blagim rastvorom sapuna (maks. 1%, bez alkohola i abraziva).



Bahasa Indonesia

Bersihkan menggunakan kain lembut yang dibasahi air dan deterjen atau sabun berbusa sedikit non-abrasif, jika perlu. Lalu, lap hingga kering dengan kain bersih.

Cara melepas film pelindung pada produk Anda

- Sebelum merakit, lepaskan film pelindung dari tepi dan permukaan lain yang dapat mengganggu perakitan.
- Cabut film pelindung yang tersisa untuk menghindari kerusakan selama perakitan. Setelah perakitan, lepaskan semua film pelindung.
- Catatan - permukaan mungkin sangat sensitif terhadap goresan setelah melepas film pelindung.
- Untuk lebih meningkatkan ketahanan terhadap goresan, lap permukaan dengan larutan sabun ringan (maks. 1%, jangan dengan alkohol atau zat abrasif).

Slovensky

V prípade potreby utrite mäkkou handričkou namočenou vo vode a jemným neabrazívnym čistiacim prostriedkom na umývanie riadu alebo mydlom. Utrite do sucha čistou handričkou

Ako zaobchádzať s výrobkami s ochrannou fóliou

- Pred montážou odstráňte ochranný film z hrán a iných povrchov, ktoré by mohli byť montážou prekryté.
- Zostávajúcu ochrannú fóliu ponechajte, aby sa pri montáži výrobok nepoškodil. Po montáži zvyšok ochrannej fólie odstráňte.
- Pozor, povrchy môžu byť okamžite po odstránení ochrannej fólie mimoriadne citlivé na poškriabanie.
- Aby ste zlepšili ich odolnosť proti poškriabaniu, utrite povrchy jemným mydlovým roztokom (max. 1%, bez alkoholu alebo drsných čističiek).



Slovenščina

Očisti z mehko krpo, navlaženo z vodo, po potrebi lahko tudi z nežnim neabrazivnim čistilnim sredstvom. Obriši do suhega s čisto krpo.

Kako ravnati z izdelki z zaščitno folijo

- Pred montažo odstrani zaščitno folijo z robov in drugih površin, kjer lahko ta ovira montažo.
- Na preostalih mestih ne odstrani zaščitne folije, da se površina med montažo ne poškoduje.
- Pomni – takoj po odstranitvi folije je površina posebno občutljiva na praske.
- Za boljšo odpornost proti praskam površine prebriši z mehko krpo, navlaženo z blago milnico (največ 1% raztopino brez alkohola ali abrazivnih sredstev).

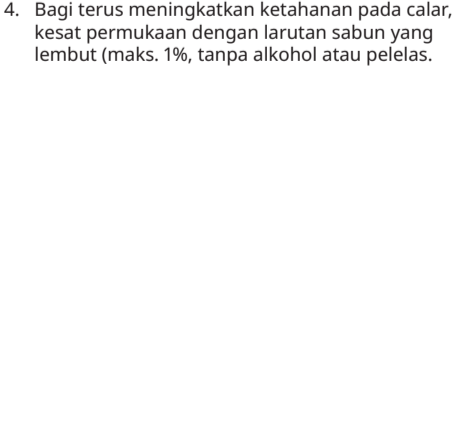
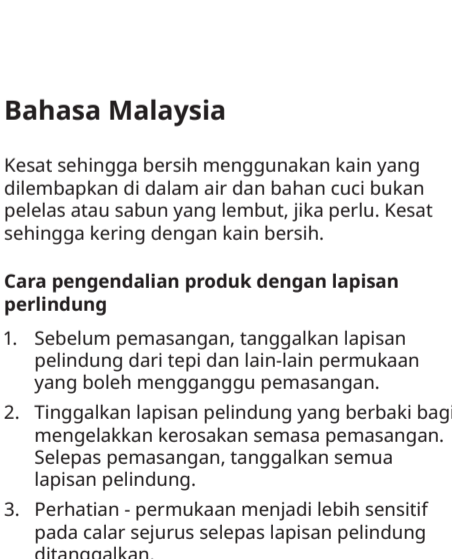

Български

Ако е необходимо, почистете с кърпа навлажнена с вода и мек неабразивен препарат или сапун. После подсушете с чиста кърпа.

Работа с продукти покрити с предпазно фолио

- Преди да започнете сглобяването премахнете предпазното фолио от ъглите и от други повърхност, ако пречат на сглобяването.
- Оставете останалото предпазно фолио с цел защита от щети по време на сглобяването. Премахнете изцяло предпазното фолио след като сте приключили със сглобяването.
- Забележка - след като премахнете предпазното фолио някои повърхности могат да бъдат по-уязвими на надраскване.
- За да направите артикула по-устойчив на надраскване, избършете повърхностите с мек сапунен разтвор (макс. 1%, без алкохол или абразивни елементи).



Türkçe

Suyla nemlendirilmis yumusak bir bez ve gerekirse hafif aşındırıcı olmayan bir deterjan veya sabunla silin. Temiz bir bezle kurulayın.

Koruyucu film ile kullanımı

- Montajdan önce, koruyucu filmi kenarlardan ve montaj engelleyebilecek diğer yüzeylerden çıkarın.
- Montaj sırasında hasar görmemesi için kalan koruyucu filmi bırakın. Montajdan sonra, tüm koruyucu filmi çıkarın.
- Not - koruyucu filmi çıkardıktan hemen sonra yüzeyler çiziklere karşı aşırı duyarlı olabilir.
- Çizilmelere karşı direnci arttırmak için, yüzeyleri yumuşak bir sabun çözeltisiyle silin (en fazla %1, alkol veya aşındırıcı madde içermemel).



Hrvatski

Očistiti krpom natopljenom u blagi deterđzent za pranje ili sapun, po potrebi. Osušiti čistom krpom.

Kako rukovati proizvodima sa zaštitnom folijom

- Prije sastavljanja, skinuti zaštitni sloj s rubova ili ostalih površina koje mogu smetati pri sastavljanju.
- Ostaviti preostalu foliju radi izbjegavanja oštećenja nastalih tijekom sastavljanja. Nakon sastavljanja, skinuti svu zaštitnu foliju.
- Napomena – police mogu biti dodatno osjetljive na ogrebotine odmah po skidanju zaštitnog sloja.
- Za povećavanje otpornosti na ogrebotine, prebriši površine blagom sapunskom otopinom (maks. 1 %, bez alkohola ili abraziva).

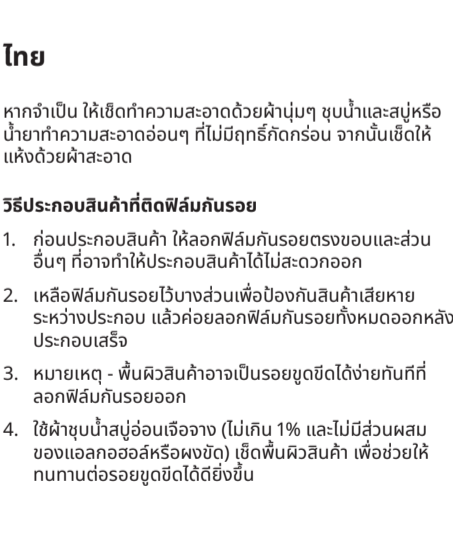
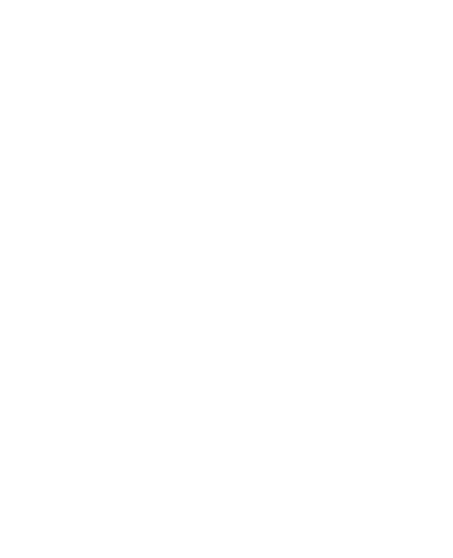
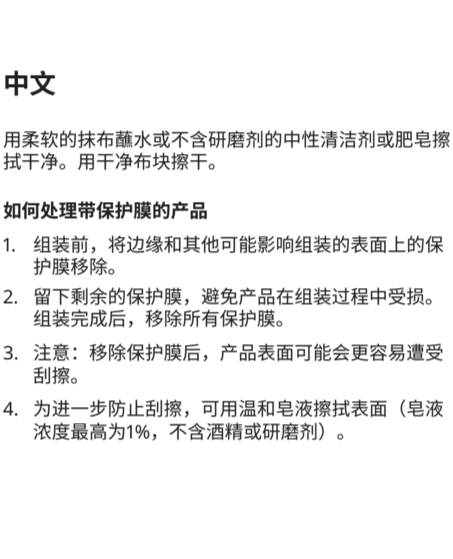

Ελληνικά

Καθαρίστε με ένα μαλακό πανί μουσκεμένο σε νερό και ήπιο, μη διαβρωτικό απορρυπαντικό ή σαπούνι, αν είναι απαραίτητο. Σκουπίστε με ένα καθαρό και στεγνό πανί.

Χρήση προϊόντων με την προστατευτική μεμβράνη

- Πριν την συναρμολόγηση, αφαιρέστε την προστατευτική μεμβράνη από τις άκρες και από άλλες επιφάνειες που μπορεί να παρεμβαίνει στην συναρμολόγηση.
- Αφήστε την προστατευτική μεμβράνη που υπολείπεται για να προστατεύσετε την επιφάνεια κατά τη διάρκεια της συναρμολόγησης. Μετά την συναρμολόγηση αφαιρέστε όλη την μεμβράνη.
- Σημείωση-οι επιφάνειες μπορεί να είναι πολύ ευαίσθητες στις γρατσουνιές αμέσως μετά την αφαίρεση της μεμβράνης.
- Για να βελτιώσετε περισσότερο την αντοχή στις γρατσουνιές, καθαρίστε τις επιφάνειες με ένα ήπιο διάλυμα σαπουνιού (μέγ. 1%, χωρίς αλκοόλ ή διαλύτες).

