

Íslenska

burrkaðu af með rökum örtrefjaklút, fyrir erfiðari bletti skalt þú nota milt hreinsiefni og nudda varlega með hringlaga hreyfingum.

Meðhöndlun vara með varnarfilmu

- Fjarlægðu filmuna af brúnum og öðru yfirborði sem gæti haft áhrif á samsetninguna.
- Skildu varnarfilmu á öðrum stöðum eftir er til að koma í veg fyrir skemmdir meðan þú setur saman vöruna. Fjarlægðu alla varnarfilmu eftir samsetningu.
- Athugaðu – yfirborð gæti verið mjög viðkvæmt fyrir rispum rétt eftir að filman hefur verið fjarlægð.
- Burrkaðu af yfirborðinu með rökum örtrefjaklút til að koma í veg fyrir rispur. Notaðu milt hreinsiefni á erfiða bletti og nuddaðu því varlega með hringlaga hreyfingu.
- Strjúktu aftur yfir með þurrum og hreinum klút.

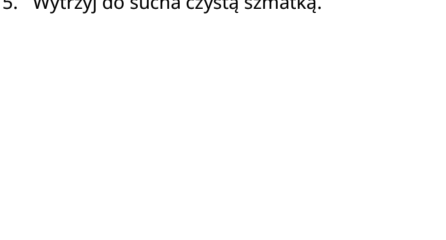
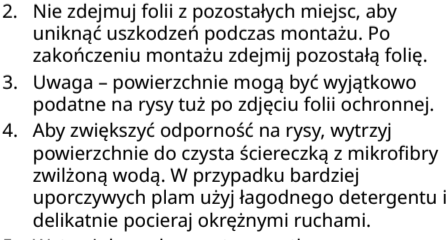
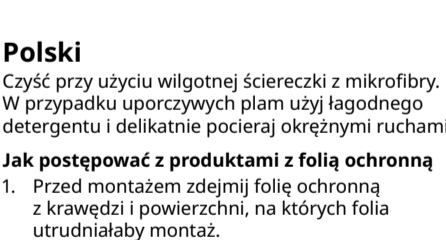
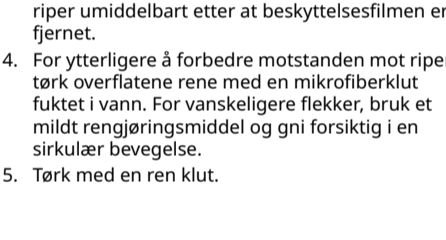
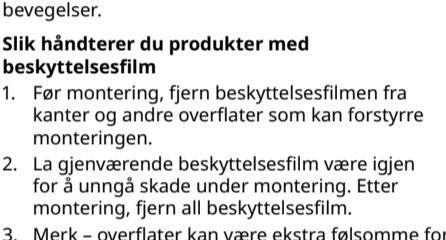
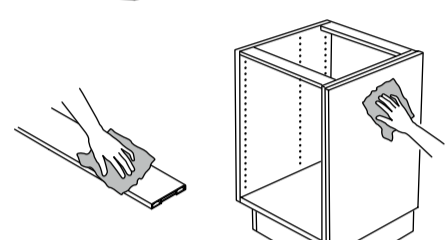
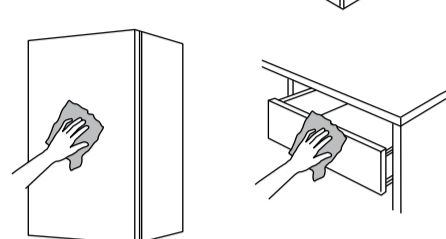
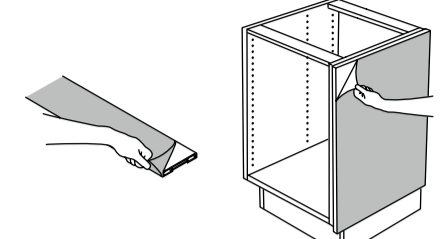
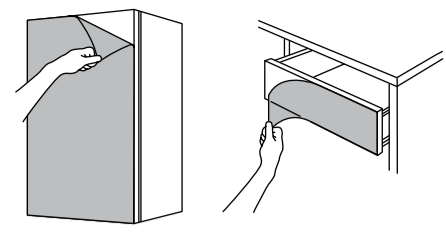
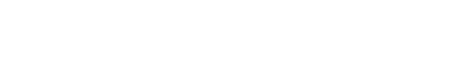
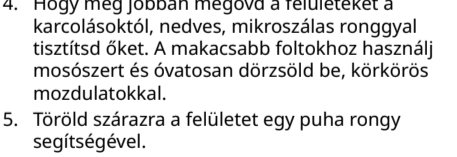
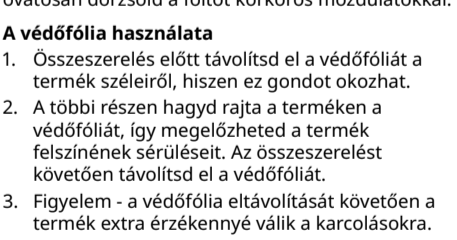
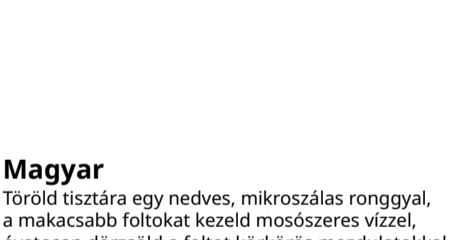

English

Wipe clean with a microfiber cloth dampened in water, for more difficult stains use a mild cleaning detergent and rub carefully with circular motions.

How to handle your products with protective film

- Before assembly, remove protective film from edges and other surfaces which may interfere with assembly.
- Leave remaining protective film to avoid damage during assembly. After assembly, remove all protective film.
- Note – surfaces may be extra sensitive to scratches immediately after removing the protective film.
- To further improve resistance to scratches, wipe surfaces clean with a microfiber cloth dampened in water. For more difficult stains use a mild cleaning detergent and rub carefully in a circular motion.
- Wipe dry with a clean cloth.

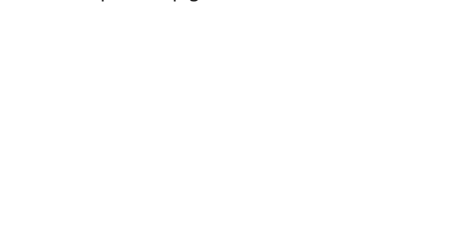
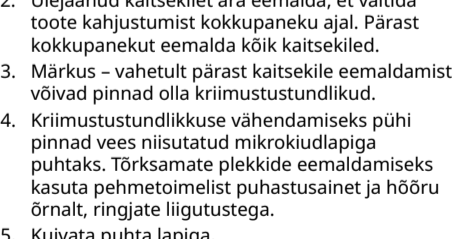
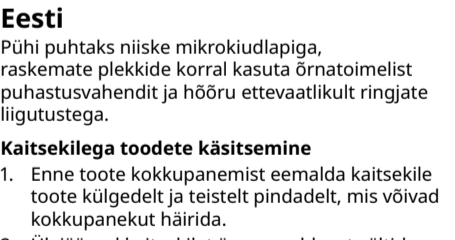
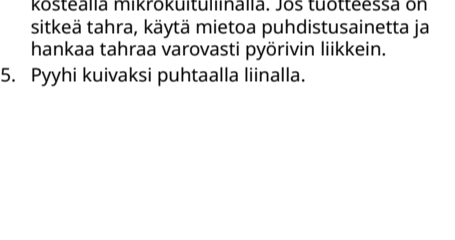
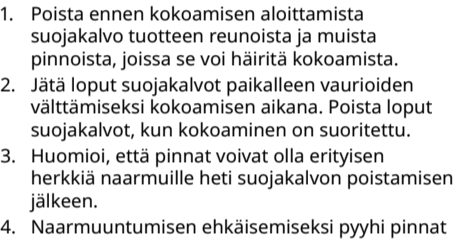
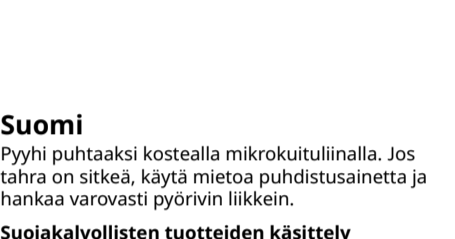

Deutsch

Mit einem mit Wasser befeuchteten Mikrofasertuch sauber wischen, bei hartnäckigeren Flecken zusätzlich ein mildes Reinigungsmittel verwenden und sorgfältig mit Kreisbewegungen auf dem Fleck reiben.

Behandlung von Produkten mit Schutzfolie

- Vor der Montage die Schutzfolie von der Kante und anderen Oberflächen entfernen, wo sie bei der Montage störend sein könnte.
- Die übrige Schutzfolie am Produkt belassen, um Schäden beim Montieren zu vermeiden. Die Schutzfolie nach der Montage komplett entfernen.
- Bitte beachten – direkt nach Entfernen der Schutzfolie kann die Oberfläche besonders empfindlich gegen Kratzer sein.
- Zur Erhöhung der Strapazierfähigkeit die Oberfläche mit einem mit Wasser befeuchteten Mikrofasertuch abwischen. Bei hartnäckigen Flecken ein mildes Reinigungsmittel verwenden und den Fleck vorsichtig mit Kreisbewegungen wegreiben.
- Mit einem sauberen Tuch nachtrocknen.

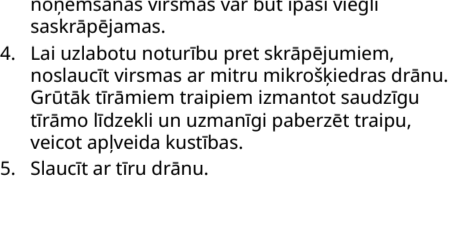
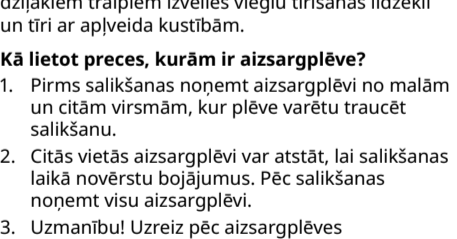
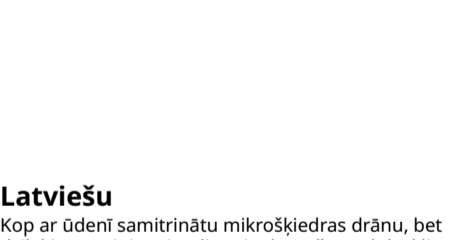
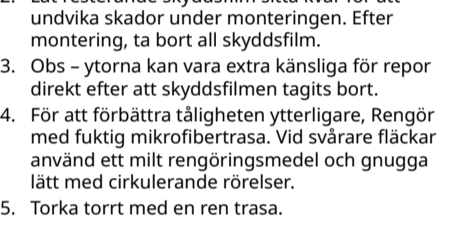
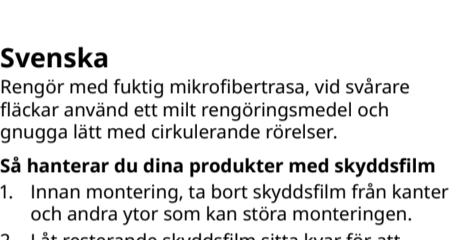

Français

Nettoyez à l'aide d'une chiffon microfibre humide. Pour les taches les difficiles, utilisez une savon doux et frottez délicatement en effectuant un mouvement circulaire.

Que faire du film protecteur sur les produits.

- Avant le montage, retirez le film de protection qui pourrait gêner, notamment au niveau des coins ou sur certaines surfaces.
- Laissez le film de de protection s'il ne gêne pas, afin d'éviter tout risque de dommages lors du montage. Après le montage, retirez tout le film protecteur.
- Attention : une fois le film retiré, la surface craint particulièrement les rayures.
- Pour renforcer la résistance aux rayures, nettoyez la surface avec un chiffon microfibre humide. Pour les taches plus difficiles, utilisez un savon doux et frotter délicatement en effectuant un mouvement circulaire.
- Essuyer avec un chiffon propre.

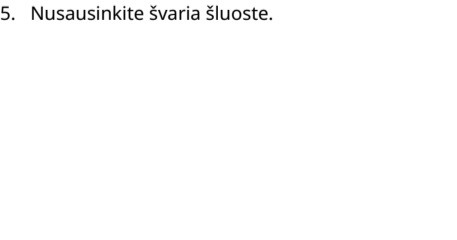
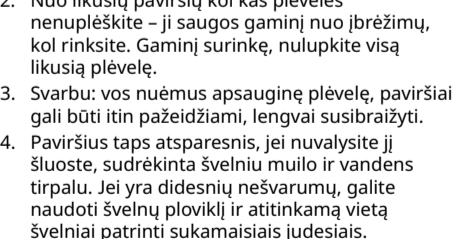
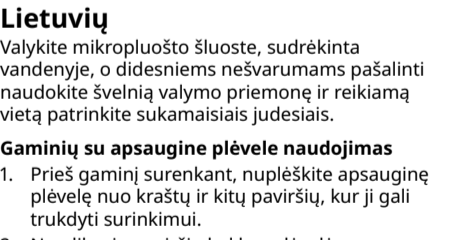
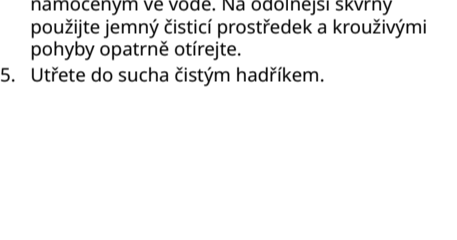
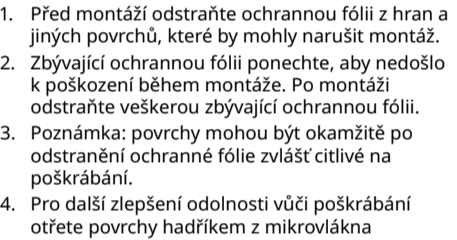
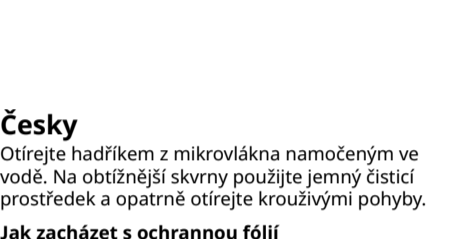
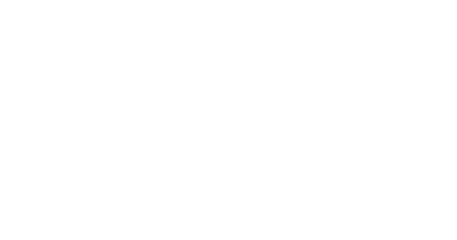

Nederlands

Veeg schoon met een vochtig microvezeldoekje. Hardnekkige vlekken verwijder je met een mild schoonmaakmiddel; wrijf voorzichtig met draaiende bewegingen.

Omgaan met producten met beschermfolie

- Voor de montage, verwijder de beschermfolie van de randen en andere oppervlakken die de montage kunnen belemmeren.
- Laat de resterende beschermfolie zitten om beschadiging tijdens de montage te voorkomen. Verwijder na de montage alle beschermfolie.
- Let op - oppervlakken kunnen meteen nadat de beschermfolie verwijderd is extra gevoelig zijn voor krassen.
- Neem om de slijtvastheid nog verder te verbeteren de oppervlakken af met een vochtig microvezeldoekje. Gebruik voor de moeilijkere vlekken een mild schoonmaakmiddel en wrijf voorzichtig met draaiende bewegingen.
- Veeg droog met een schone doek.

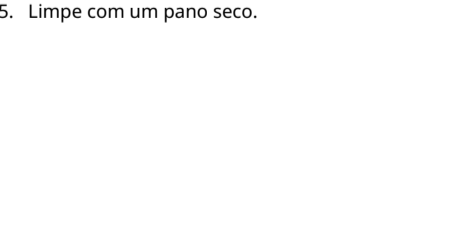
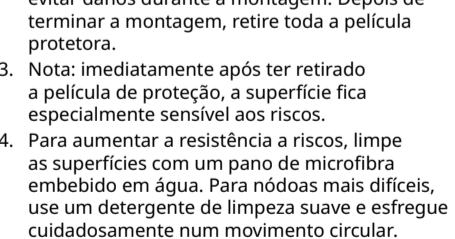
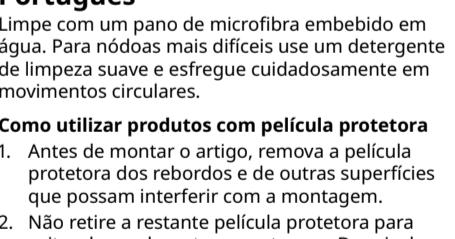
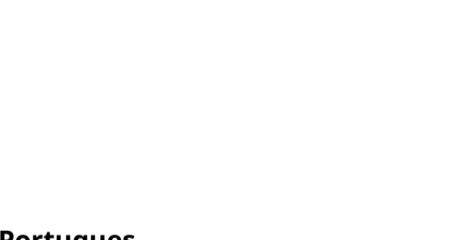
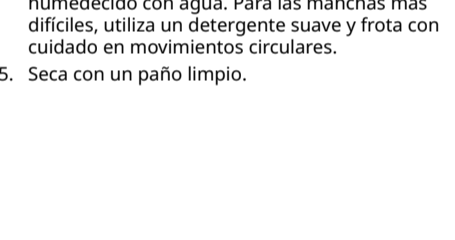
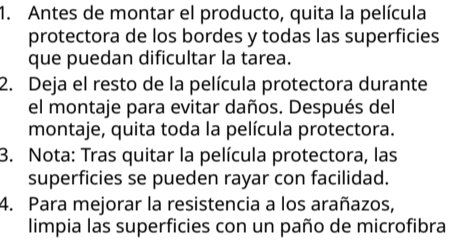
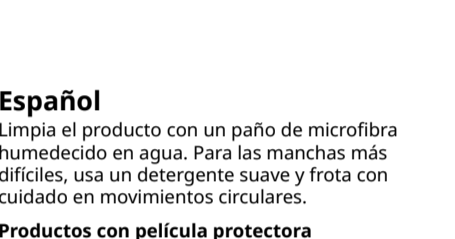

Dansk

Tørres af med en fugtig mikrofiberklud. Til mere vanskelige pletter bruges et mildt rengøringsmiddel, hvormed der gnides forsigtigt i cirkelbevægelser.

Sådan håndterer du produkter med beskyttelsesfilm

- Før du samler produktet, skal du fjerne beskyttelsesfilmen fra kanter og andre overflader, der kan vanskeliggøre monterng.
- Lad beskyttelsesfilmen sidde de øvrige steder, så du ikke beskadiger produktet under monterng. Fjern al beskyttelsesfilm efter monterng.
- BEMÆRK!** Umiddelbart efter at du har fjernet beskyttelsesfilmen, kan overfladen være særligt modtagelig over for ridser.
- For at gøre overfladen stærkere, skal du tørre den af med en fugtig mikrofiberklud Brug mildt rengøringsmiddel ved vanskelige pletter, og skrub forsigtigt i cirkulære bevægelser.
- Tør efter med en tør og ren klud.

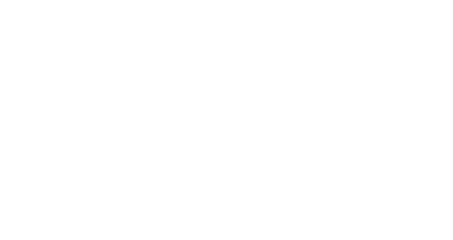
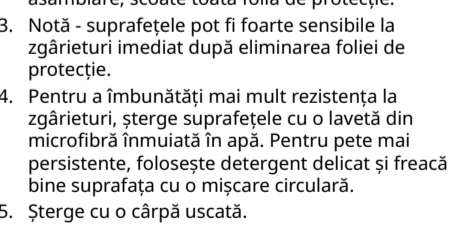
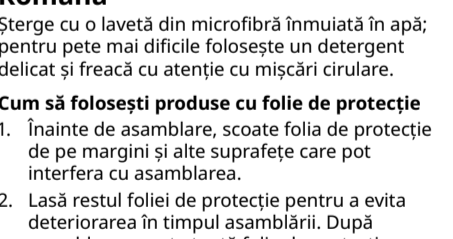
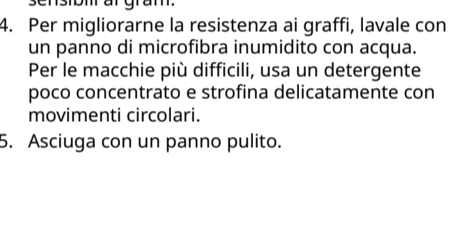
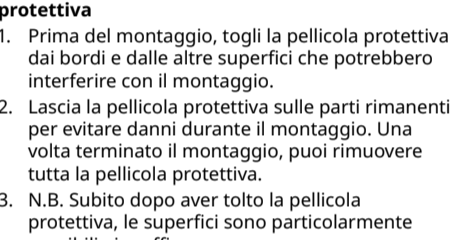
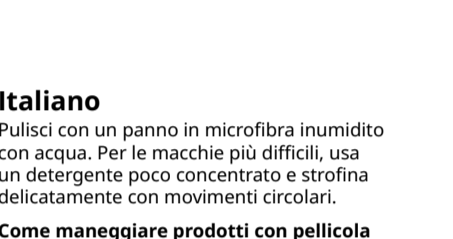

Magyar

Töröld tisztára egy nedves, mikroszálas ronggyal, a makacsabb foltokat kezeld mosószeres vízzel, óvatosan dörzsöld a foltot körkörös mozdulatokkal.

A védőfólia használat

- Összeszerelés előtt távolítsd el a védőfóliát a termék széleiről, hiszen ez gondot okozhat.
- A többi részen hagyd rajta a terméken a védőfóliát, így megelőzhető a termék felszínének sérüléseit. Az összeszerelést követően távolítsd el a védőfóliát.
- Figyelem - a védőfólia eltávolítását követően a termék extra érzékennyé válik a karcolásokra.
- Hogy még jobban megóvd a felületet a karcolásoktól, nedves, mikroszálas ronggyal tisztítsd őket. A makacsabb foltokhoz használj mosószert és óvatosan dörzsöld be, körkörös mozdulatokkal.
- Töröld szárazra a felületet egy puha rongy segítségével.

Polski

Czyść przy użyciu wilgotnej ściereczki z mikrofibry. W przypadku uporczywych plam użyj łagodnego detergentu i delikatnie pocieraj okrężnymi ruchami.

Jak postępować z produktami z folią ochronną

- Przed montażem zdejmij folię ochronną z krawędzi i powierzchni, na których folia utrudniałaby montaż.
- Nie zdejmuj folii z pozostałych miejsc, aby uniknąć uszkodzeń podczas montażu. Po zakończeniu montażu zdejmij pozostałą folię.
- Uwaga – powierzchnie mogą być wyjątkowo podatne na rysy tuż po zdjęciu folii ochronnej.
- Aby zwiększyć odporność na rysy, wytrzyj powierzchnie do czysta ściereczką z mikrofibry zwilżoną wodą. W przypadku bardziej uporczywych plam użyj łagodnego detergentu i delikatnie pocieraj okrężnymi ruchami.
- Wytrzyj do sucha czystą szmatką.

Eesti

Pühi puhtaks niiske mikrokiudlapiga, raskemate plekkide korral kasuta õrnatoimelist puhastusvahendit ja hõõru ettevaatlikult ringjate liigutustega.

Kaitsekilega toodete käsitemine

- Enne toote kokkupanemist eemalda kaitsekile toote külgedelt ja teistelt pindadelt, mis võivad kokkupanekut häirida.
- Ülejäänud kaitsekilet ära eemalda, et vältida toote kahjustumist kokkupaneku ajal. Pärast kokkupanekut eemalda kõik kaitsekiled.
- Märkus – vahetult pärast kaitsekile eemaldamist võivad pinnad olla kriimustustundlikud.
- Kriimustustundlikkuse vähendamiseks pühi pinnad vees niisutatud mikrokiudlapiga puhtaks. Tõrksamate plekkide eemaldamiseks kasuta pehmetoimelist puhastusainet ja hõõru õrnalt, ringjate liigutustega.
- Kuivata puhta lapiga.

Latviešu

Kop ar dieni samitrinātu mikrošķiedras drānu, bet dziļākiem traipiem izvēlies vieglu tīrīšanas līdzekli un tīri ar apļveida kustībām.

Kā lietot preces, kurām ir aizsargplēve?

- Pirms salikšanas noņem aizsargplēvi no malām un citām virsmām, kur plēve varētu traucēt salikšanu.
- Citās vietās aizsargplēvi var atstāt, lai salikšanas laikā novērstu bojājumus. Pēc salikšanas noņem visu aizsargplēvi.
- Uzmanību! Uzreiz pēc aizsargplēves noņemšanas virsmas var būt īpaši viegli saskrāpējamas.
- Lai uzlabotu noturību pret skrāpējumiem, noslaucīt virsmas ar mitru mikrošķiedras drānu. Grūtāk tīrāmiem traipiem izmantot saudzīgu tīrāmo līdzekli un uzmanīgi paberzēt traipu, veicot apļveida kustības.
- Slaucīt ar tīru drānu.

Lietuvių

Valykite mikropluošto šluoste, sudrėkinta vandenyje, o didesniems nešvarumams pašalinti naudokite švelnią valymo priemonę ir reikiamą vietą patrinkite sukamaisiais judesiais.

Gaminį su apsaugine plėvele naudojimas

- Prieš gaminį surenkant, nuplėškite apsauginę plėvelę nuo kraštų ir kitų paviršių, kur ji gali trukdyti surinkimui.
- Nuo likusių paviršių kol kas plėvelės nenuplėškite – ji saugos gaminį nuo įbrėžimų, kol rinksite. Gaminį surinkę, nulupkite visą likusią plėvelę.
- Svarbu: vos nuėmus apsauginę plėvelę, paviršiai gali būti itin pažeidžiami, lengvai susibraižyti.
- Paviršius taps atsparesnis, jei nuvalysite jį šluoste, sudrėkinta švelniu muilo ir vandens tirpalu. Jei yra didesnių nešvarumų, galite naudoti švelnų ploviklį ir atitinkamą vietą švelniai patrinti sukamaisiais judesiais.
- Nusausinkite švaria šluoste.

Portugues

Limpe com um pano de microfibra embebido em água. Para nódoas mais difíceis use um detergente de limpeza suave e esfregue cuidadosamente em movimentos circulares.

Como utilizar produtos com película protetora

- Antes de montar o artigo, remova a película protetora dos rebordos e de outras superfícies que possam interferir com a montagem.
- Não retire a restante película protetora para evitar danos durante a montagem. Depois de terminar a montagem, retire toda a película protetora.
- Nota: imediatamente após ter retirado a película de proteção, a superfície fica especialmente sensível aos riscos.
- Para aumentar a resistência a riscos, limpe as superfícies com um pano de microfibra embebido em água. Para nódoas mais difíceis, use um detergente de limpeza suave e esfregue cuidadosamente num movimento circular.
- Limpe com um pano seco.

Română

Șterge cu o lavetă din microfibră înmuiată în apă; pentru pete mai dificile folosește un detergent delicat și freacă cu atenție cu mișcări circulare.

Cum să folosești produse cu folie de protecție

- Înainte de asamblare, scoate folia de protecție de pe margini și alte suprafețe care pot interfera cu asamblarea.
- Lasă restul foliei de protecție pentru a evita deteriorarea în timpul asamblării. După asamblare, scoate toată folia de protecție.
- Notă - suprafețele pot fi foarte sensibile la zgârieturi imediat după eliminarea foliei de protecție.
- Pentru a îmbunătăți mai mult rezistența la zgârieturi, șterge suprafețele cu o lavetă din microfibră înmuiată în apă. Pentru pete mai persistente, folosește detergent delicat și freacă bine suprafața cu o mișcare circulară.
- Șterge cu o cârpă uscată.

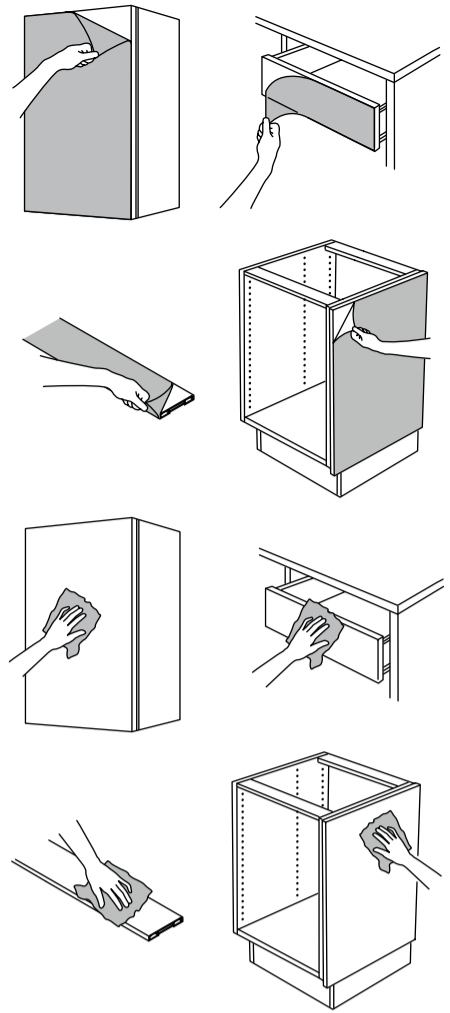

Srpski

Očisti krpom od mikrofibera koja je nakvašena vodom, a u slučaju fleka koje se teže skidaju, koristi blagi deterđent za čišćenje i pažljivo trljaj kružnim pokretom.

Kako da rukuješ proizvodima sa zaštitnom folijom

- Pre sastavljanja, ukloni foliju s ivica i drugih površina koje mogu uticati na sastavljanje.
- Ostavi preostalu zaštitnu foliju da izbegneš oštećenja tokom sastavljanja. Posle sastavljanja ukloni zaštitnu foliju.
- Napomena – površine mogu biti posebno osetljive na ogrebotine neposredno posle uklanjanja zaštitne folije.
- Da dodatno poboljšaš otpornost na ogrebotine, prebriši površine krpom od mikrofibera navlaženom vodom. U slučaju fleka koje se teže skidaju, koristi blagi deterđent za čišćenje i pažljivo trljaj kružnim pokretom.
- Obriši čistom krpom.



Bahasa Indonesia

Lap bersih dengan kain mikrofiber yang dibasahi air, untuk noda yang lebih sulit gunakan detergen pembersih yang lembut dan gosok dengan hati-hati dengan gerakan memutar.

Cara melepas film pelindung pada produk Anda

- Sebelum merakit, lepaskan film pelindung dari tepi dan permukaan lain yang dapat mengganggu perakitan.
- Cabut film pelindung yang tersisa untuk menghindari kerusakan selama perakitan. Setelah perakitan, lepaskan semua film pelindung.
- Catatan - permukaan mungkin sangat sensitif terhadap goresan setelah melepas film pelindung.
- Untuk lebih meningkatkan ketahanan terhadap goresan, bersihkan permukaan dengan kain mikrofiber yang dibasahi air. Untuk noda yang lebih sulit, gunakan detergen pembersih ringan dan gosok dengan hati-hati dengan gerakan melingkar.
- Lalu lap kering dengan kain yang bersih.

Slovensky

Čistite handričkou z mikrovlákná navlhčenou vo vode, na ťažšie škvrny použite jemný čistiaci prostriedok a kruživými pohybmi opatrne vtierajte.

Ako zaobchádzať s výrobkami s ochrannou fóliou

- Pred montážou odstráňte ochranný film z hrán a iných povrchov, ktoré by mohli byť montážou prekryté.
- Zostávajúcu ochrannú fóliu ponechajte, aby sa pri montáži výrobok nepoškodil. Po montáži zvyšok ochrannej fólie odstráňte.
- Pozor, povrchy môžu byť okamžite po odstránení ochrannej fólie mimoriadne citlivé na poškriabanie.
- Na ďalšie zlepšenie odolnosti voči poškriabaniu utrite povrchy handričkou z mikrovlákná navlhčenou vo vode. Na zložitejšie škvrny použite jemný čistiaci prostriedok a opatrne vtierajte kruživými pohybmi.
- Utrite dosucha čistou textíliou.



Slovenščina

Obriši s krpo iz mikrovlaken, navlaženo z vodo, za trdovratnejše madeže pa uporabi nežno čistilno sredstvo in previdno drgni s krožnimi gibi.

Kako ravnati z izdelki z zaščitno folijo

- Pred začetkom sestavljanja odstrani zaščitno folijo z robov in drugih površin, kjer lahko ta ovira sestavljanje.
- Na preostalih mestih ne odstrani zaščitne folije, da se površina med sestavljanjem ne poškoduje. Ko zaključiš sestavljanje, odstrani vso zaščitno folijo.
- Pomni – takoj po odstranitvi folije je površina posebno občutljiva za praske.
- Za boljšo odpornost proti praskam površine prebriši s krpo iz mikrovlaken, navlaženo z vodo. Za bolj trdovratne madeže uporabi blagi detergent in previdno zdrgni s krožnimi gibi.
- Do suhega obriši s čisto in suho krpo.

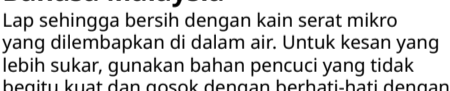

Bahasa Malaysia

Lap sehingga bersih dengan kain serat mikro yang dilembapkan di dalam air. Untuk kesan yang lebih sukar, gunakan bahan pencuci yang tidak begitu kuat dan gosok dengan berhati-hati dengan gerakan membulat.

Cara pengendalian produk dengan lapisan perlindungan

- Sebelum pemasangan, tanggalkan lapisan pelindung dari tepi dan lain-lain permukaan yang boleh mengganggu pemasangan.
- Tinggalkan lapisan pelindung yang berbaki bagi mengelakkan kerosakan semasa pemasangan. Selepas pemasangan, tanggalkan semua lapisan pelindung.
- Perhatian - permukaan menjadi lebih sensitif pada calar seurus selepas lapisan pelindung ditanggalkan.
- Bagi meningkatkan lagi ketahanan terhadap permukaan, kesat permukaan sehingga bersih dengan kain gentian mikro yang dilembapkan di dalam air. Bagi kotoran yang lebih degil, gunakan bahan pencuci yang tidak begitu kuat dan gosok secara berhati-hati dalam gerakan membulat.
- Selepas sehingga kering dengan kain yang bersih.

Български

Почистете с микрофибърна кърпа, навлажнена с вода. За по-упорити петна използвайте нежен почистващ препарат и почистете внимателно с кръгови движения.

Работа с продукти, покрити с предпазно фолио

- Преди да започнете слобяването, премахнете предпазното фолио от ъглите и от други повърхности, които могат да попречат на слобяването.
- Оставете останалото предпазно фолио с цел защита от щети по време на слобяването. Премахнете изцяло предпазното фолио след като сте приключили със слобяването.
- Забележка - след като премахнете предпазното фолио някои повърхности могат да бъдат по-уязвими на надраскване.
- За да повишите устойчивостта на надраскване, забършете повърхностите с навлажнена с вода микрофибърна кърпа. При по-упорити петна използвайте нежен почистващ препарат и втрийте внимателно с кръгови движения.
- Избършете с чиста кърпа.

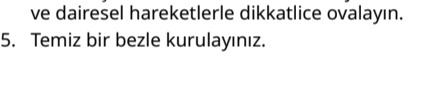
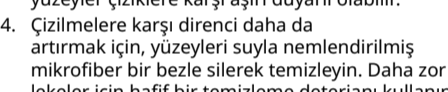
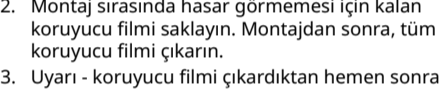
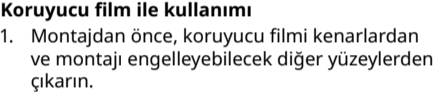
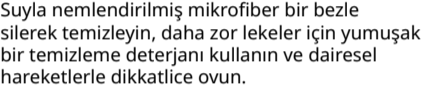
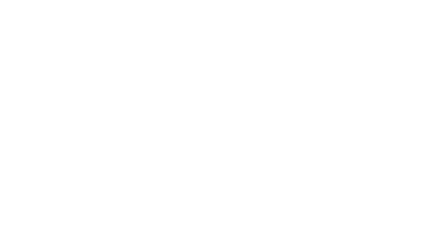

Hrvatski

Očistiti krpom od mikrovlakana namočenom u vodu, za teže mrlje koristiti blagi deterđent za čišćenje i pažljivo trljati kružnim pokretima.

Kako rukovati proizvodima sa zaštitnom folijom

- Prije sastavljanja, skinuti zaštitni sloj s rubova ili ostalih površina koje mogu smetati pri sastavljanju.
- Ostaviti preostalu foliju radi izbjegavanja oštećenja nastalih tijekom sastavljanja. Nakon sastavljanja, skinuti svu zaštitnu foliju.
- Napomena – police mogu biti dodatno osjetljive na ogrebotine odmah po skidanju zaštitnog sloja.
- Kako bi se dodatno poboljšala otpornost na ogrebotine, obrisati površine krpom od mikrovlakana namočenom u vodu. Za teže mrlje upotrijebiti blagi deterđent za čišćenje i pažljivo trljati kružnim pokretima.
- Osušiti čistom krpom.

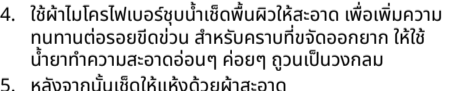
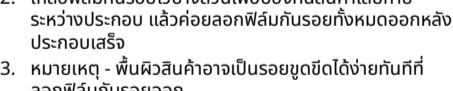
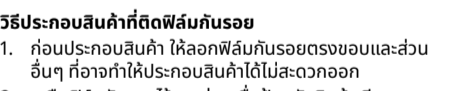
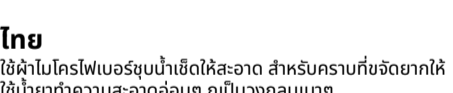
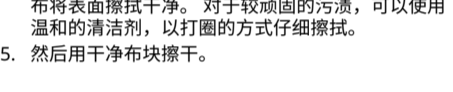
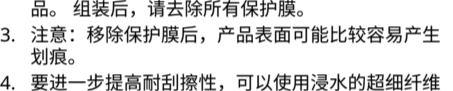
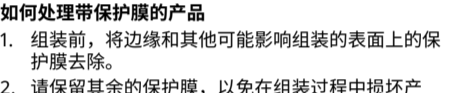
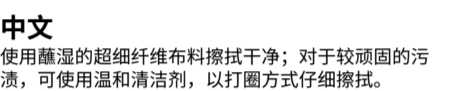
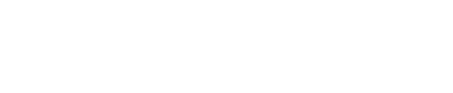

Ελληνικά

Καθαρίστε με ένα πανί μικροϊνών βρεγμένο με νερό, για πιο δύσκολους λεκέδες χρησιμοποιήστε ένα ήπιο απορρυπαντικό και τρίψτε προσεκτικά με κυκλικές κινήσεις.

Χρήση προϊόντων με την προστατευτική μεμβράνη

- Πριν τη συναρμολόγηση, αφαιρέστε την προστατευτική μεμβράνη από τις άκρες και από άλλες επιφάνειες που μπορεί να παρεμβαίνει στην συναρμολόγηση.
- Αφίστε την προστατευτική μεμβράνη που υπολείπεται για να προστατεύσετε την επιφάνεια κατά τη διάρκεια της συναρμολόγησης. Μετά την συναρμολόγηση αφαιρέστε όλη την μεμβράνη.
- Σημειώση-οι επιφάνειες μπορεί να είναι πολύ ευαίσθητες στις γρατσοεινές αμέσως μετά την αφαίρεση της μεμβράνης.
- Για να ενισχύσετε την αντίσταση στις γρατσοεινές, καθαρίστε τις επιφάνειες με πανί μικροϊνών βρεγμένο με νερό. Για πιο δύσκολους λεκέδες, χρησιμοποιήστε ήπιο απορρυπαντικό και τρίψτε προσεκτικά με κυκλικές κινήσεις.
- Σκουπίστε με ένα στεγνό, καθαρό πανί.

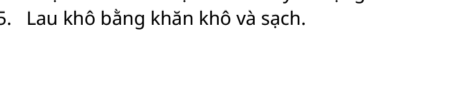
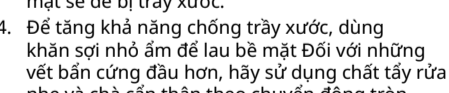
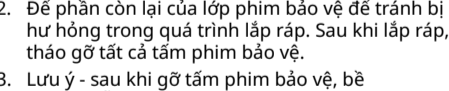
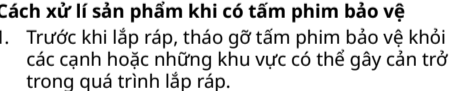
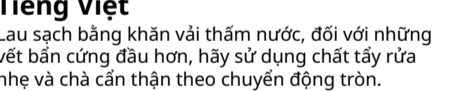
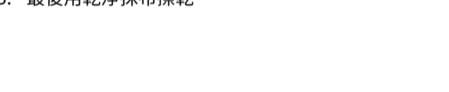
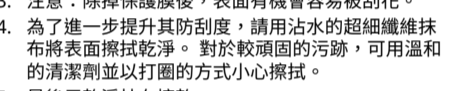
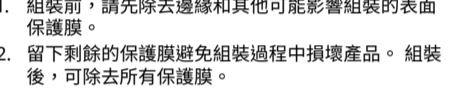
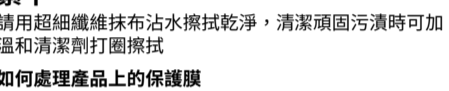

Русский

Протирать салфеткой из микрофибры, смоченной в воде. Для удаления более сложных загрязнений используйте мягкое моющее средство и круговыми движениями осторожно протрите поверхность.

Как обращаться с товарами с защитной пленкой

- Перед сборкой удалите защитную пленку с кромок и других поверхностей, где она может помешать сборке.
- Не удаляйте защитную пленку с других поверхностей, чтобы избежать повреждений при сборке. После сборки удалите всю защитную пленку.
- Внимание! Поверхности сразу после удаления защитной пленки могут быть очень чувствительны к царапинам.
- Для повышения устойчивости к царапинам протрите поверхности тканью из микрофибры, смоченной в воде. Для более сложных пятен используйте мягкое моющее средство, осторожно протирая поверхность круговыми движениями.
- Вытрите насухо чистой тканью.

