



## Dansk

Tørres eventuelt af med en blød, fugtig klud tilsat et mildt, ikke-slibende opvaskemiddel eller sæbe. Tør efter med en ren, tør klud.

**Sådan håndterer du produkter med beskyttelsesfilm**

- Før du samler produktet, skal du fjerne beskyttelsesfilmen fra kanter og andre overflader, der kan vanskeliggøre monteringen.
- Lad beskyttelsesfilmen sidde de øvrige steder, så du ikke beskadiger produktet under monteringen. Fjern al beskyttelsesfilm efter monteringen.
- BEMÆRK!** Umiddelbart efter at du har fjernet beskyttelsesfilmen, kan overfladen være særligt modtagelig over for ridser.
- For at gøre overfladen stærkere, skal du tørre den af med en blød klud og en mild sæbeopløsning (maks. 1%, ingen alkohol eller slipemidler).

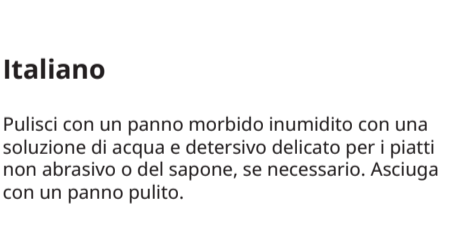

**Come maneggiare prodotti con pellicola protettiva**

- Prima del montaggio, togli la pellicola protettiva dai bordi e dalle altre superfici dove potrebbe interferire con il montaggio.
- Lascia la pellicola protettiva sulle parti rimanenti per evitare danni durante il montaggio. Una volta terminato il montaggio, puoi rimuovere tutta la pellicola protettiva.
- N.B. Subito dopo aver tolto la pellicola protettiva, la superficie è particolarmente sensibile ai graffi.
- Per migliorarne la resistenza ai graffi, lava la con una soluzione di acqua e sapone poco concentrata (max 1%). Non usare prodotti contenenti alcool o abrasivi.

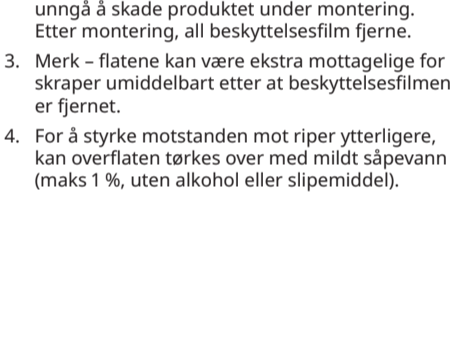
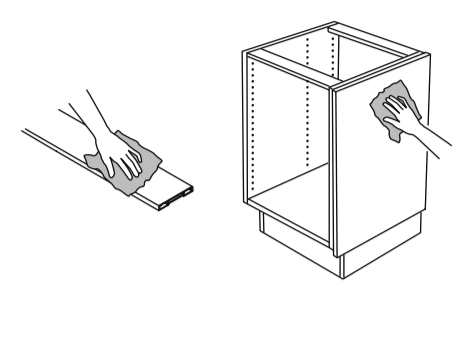
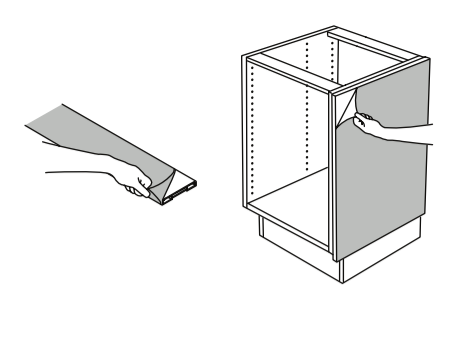
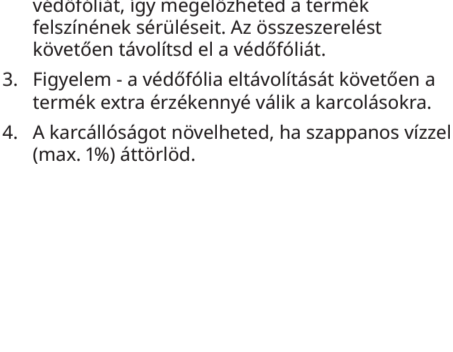
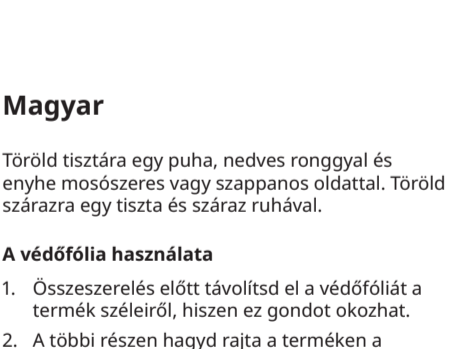
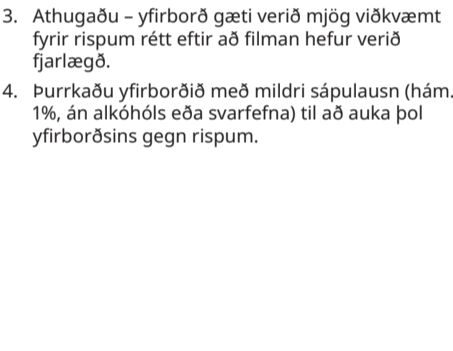
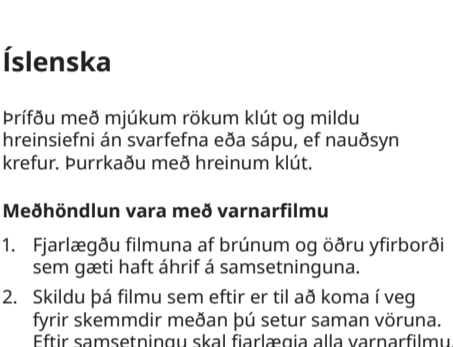
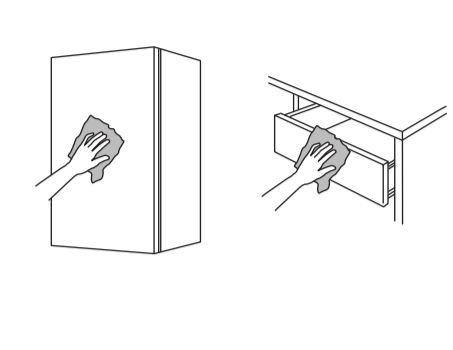
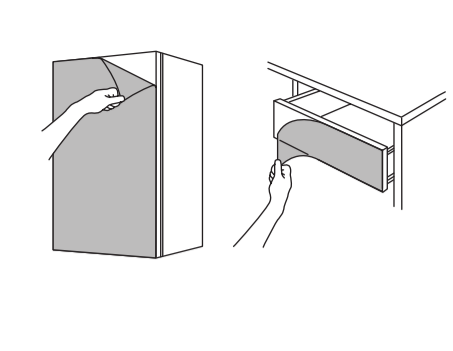

### English

Wipe clean with a soft cloth dampened in water and a mild non-abrasive washing-up detergent or soap, if necessary. Wipe dry with a clean cloth.

**How to handle your products with protective film**

- Before assembly, remove protective film from edges and other surfaces which may interfere with assembly.
- Leave remaining protective film to avoid damage during assembly. After assembly, remove all protective film.
- Note – surfaces may be extra sensitive to scratches immediately after removing the protective film.
- To further improve resistance to scratches, wipe surfaces with a mild soap solution (max. 1%, no alcohol or abrasives).

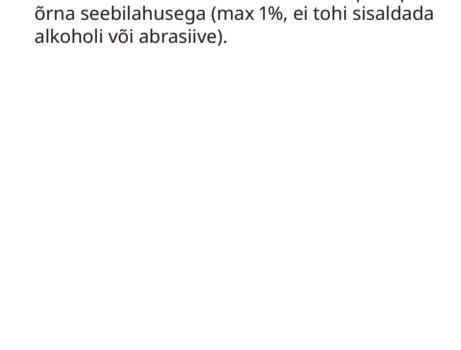
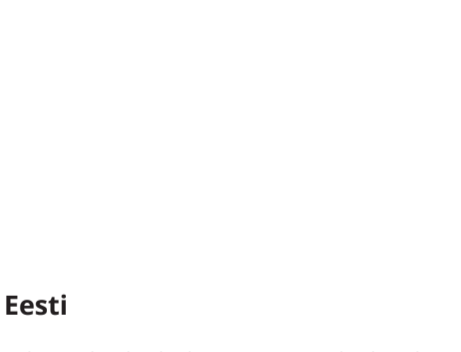
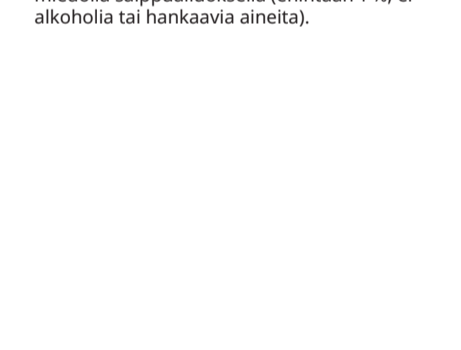
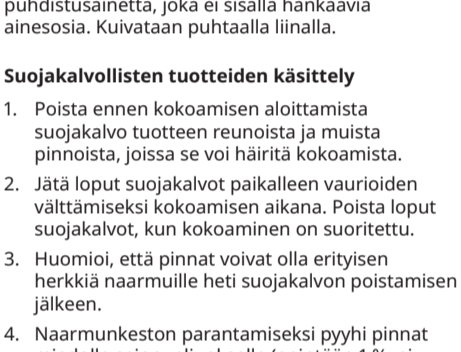

### Deutsch

Mit einem in Wasser angefeuchteten weichen Tuch und, wenn nötig, mit schleifmittelfreiem Reinigungsmittel oder Seifenlösung säubern. Mit einem sauberen Tuch abtrocknen.

**Behandlung von Produkten mit Schutzfolie**

- Vor der Montage die Schutzfolie von der Kante und anderen Oberflächen entfernen, wo sie bei der Montage störend sein könnte.
- Die übrige Schutzfolie am Produkt belassen, um Schäden beim Montieren zu vermeiden. Die Schutzfolie nach der Montage komplett entfernen.
- Bitte beachten - direkt nach Entfernen der Schutzfolie kann die Oberfläche besonders empfindlich gegen Kratzer sein.
- Zur Erhöhung der Strapazierfähigkeit die Oberfläche mit einem weichen Tuch und einer milden Seifenlauge (max. 1%; keine alkohohaltigen Mittel oder Schleifmittel) abwischen.

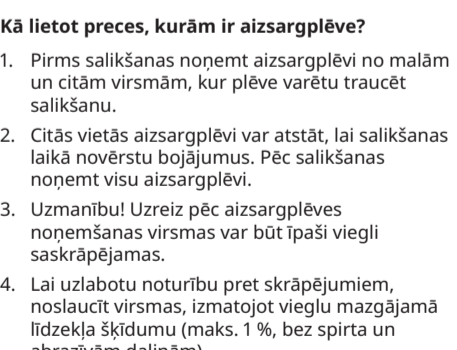
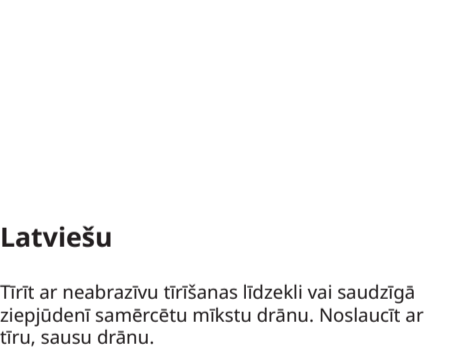
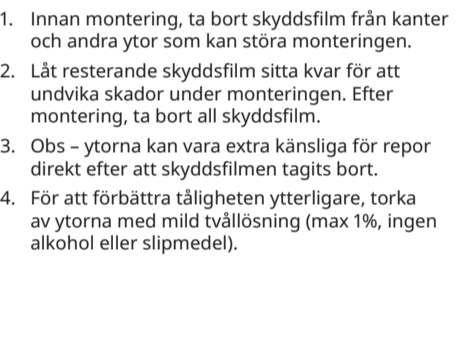
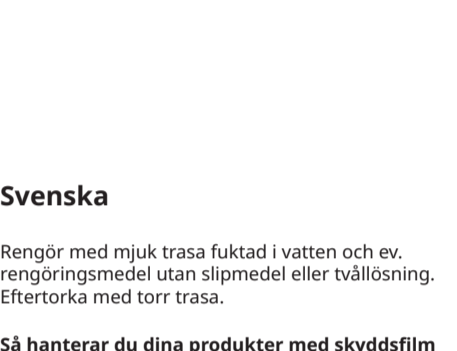

### Français

Nettoyer à l'aide d'un chiffon doux imbibé d'eau et, si besoin, d'un détergent non abrasif ou de savon. Essuyer avec un chiffon propre.

**Que faire du film protecteur sur les produits.**

- Avant le montage, retirer le film de protection qui pourrait gêner, notamment au niveau des coins ou sur certaines surfaces.
- Laisser le film de de protection s'il ne gêne pas, afin d'éviter tout risque de dommages lors du montage. Après le montage, retirer tout le film protecteur.
- Attention : une fois le film retiré, la surface craint particulièrement les rayures.
- Pour renforcer la résistance à l'usure, nettoyer à l'aide d'un chiffon doux trempé dans de l'eau savonneuse (max. 1 % de détergent).

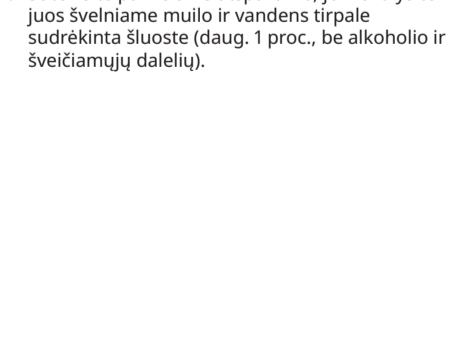
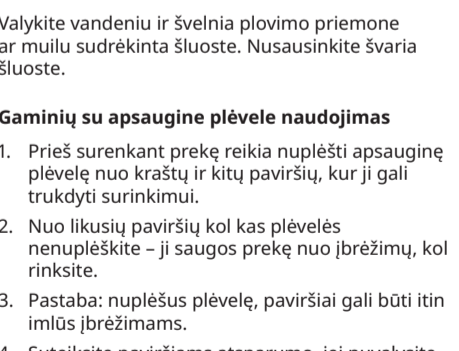
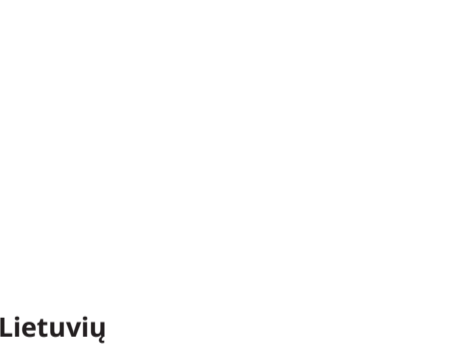
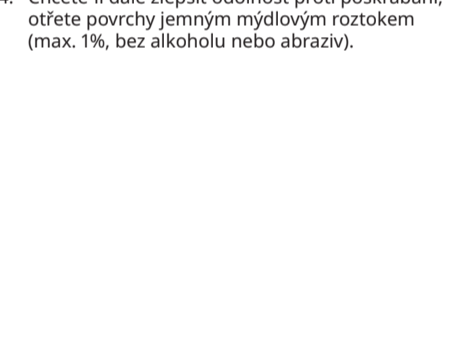
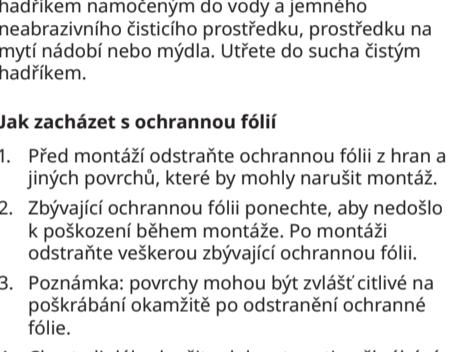
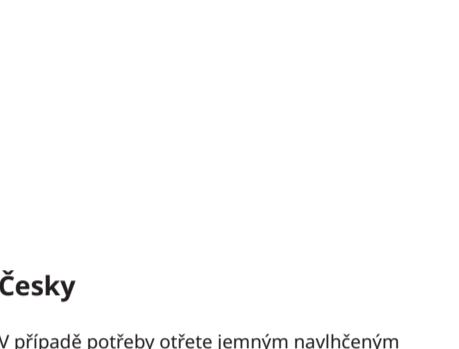
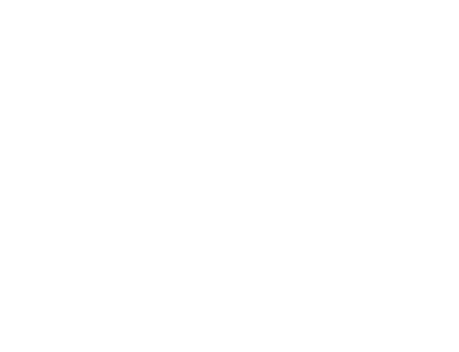

### Nederlands

Schoonmaken met een vochtig doekje met water en evt. een schoonmaakmiddel zonder schuurmiddel, of een zeepoplossing. Nadrogen met een droge doek.

**Omgaan met producten met beschermfolie**

- Voor de montage: verwijder de beschermfolie van de randen en andere oppervlakken die de montage kunnen belemmeren.
- Laat de resterende beschermfolie zitten om beschadigingen tijdens de montage te voorkomen.
- Let op - oppervlakken kunnen meteen nadat de beschermfolie verwijderd is extra gevoelig zijn voor krassen.
- Om de slijtvastheid nog verder te verbeteren, de oppervlakken afnemen met een milde zeepoplossing (max. 1 %, geen alcohol of schuurmiddel).

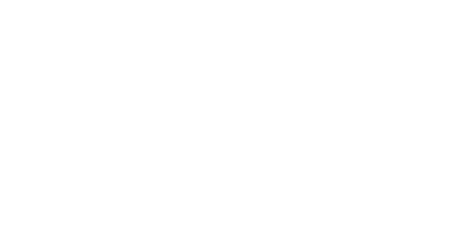
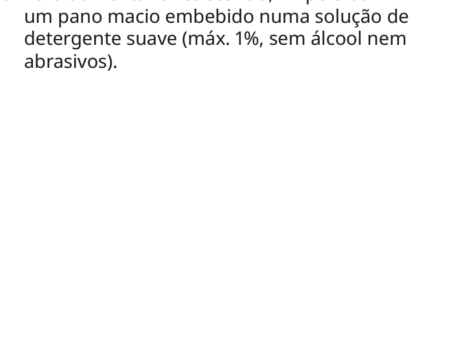
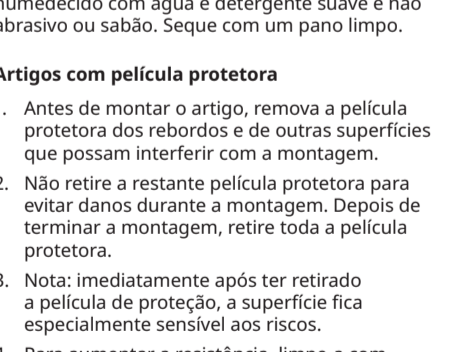
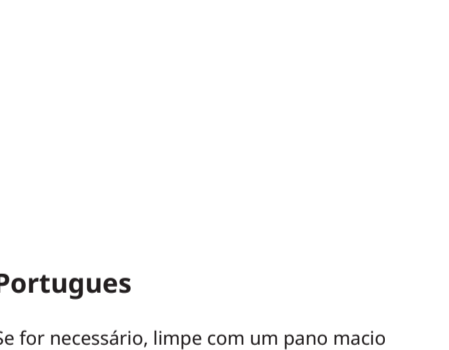
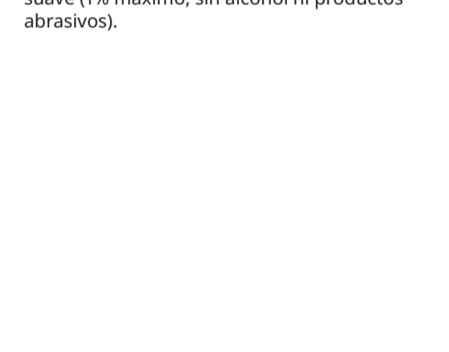
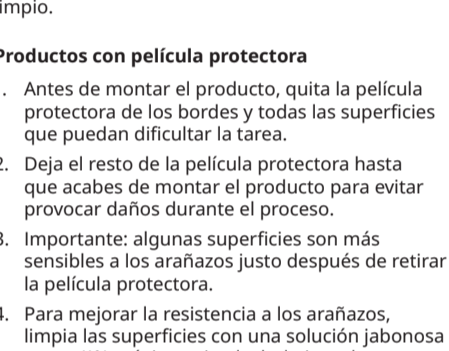
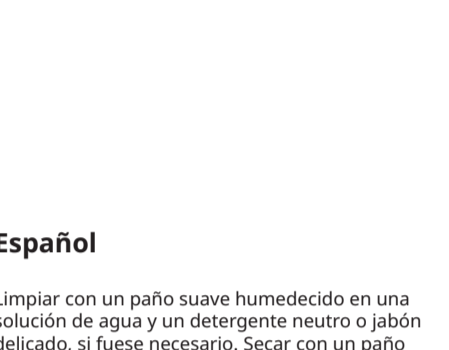

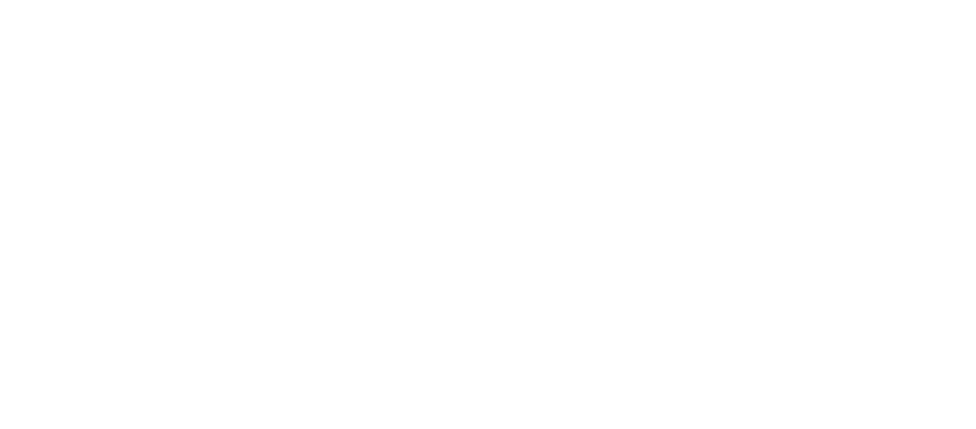
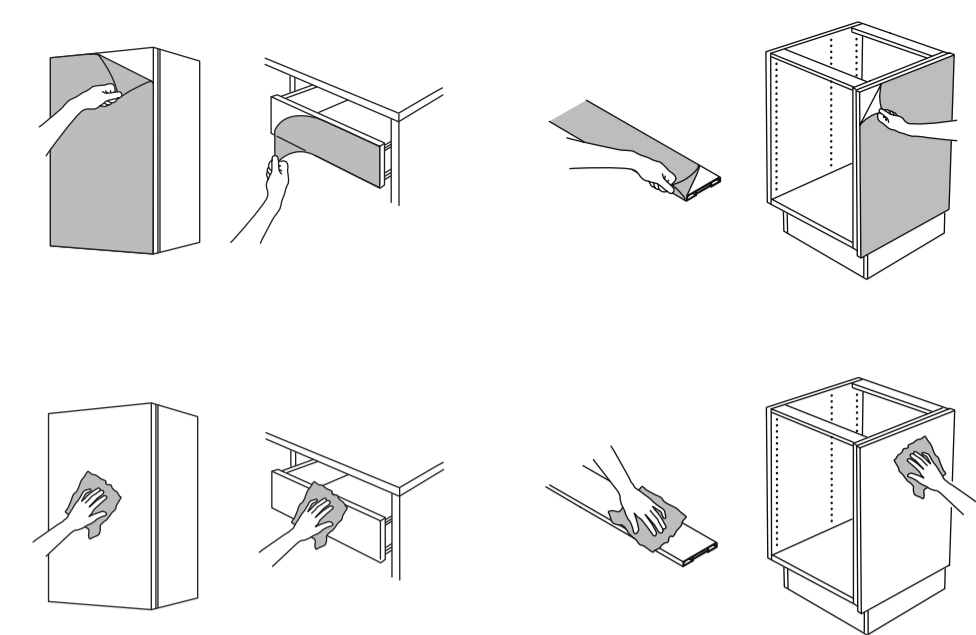

## Русский

Протирать мягкой тканью, смоченной в воде с добавлением при необходимости мягкого неабразивного моющего средства или мыла. Затем вытирать чистой тканью.

**Как обращаться с товарами с защитной пленкой**

- Перед сборкой удалите защитную пленку с кромок и других поверхностей, где она может помешать сборке.
- Не удаляйте защитную пленку с других поверхностей, чтобы избежать повреждений при сборке. После сборки удалите всю защитную пленку.
- Внимание! Поверхности сразу после удаления защитной пленки могут быть очень чувствительны к царапинам .
- Для повышения устойчивости к царапинам протрите поверхности тканью, смоченной в слабом мыльном растворе (не более 1%, без спирта и абразивов).



### 한국어

부드러운 천을 물에 적신 뒤 비마모성 주방세제나 비누를 묻혀 닦아주세요. 깨끗한 천으로 물기를 닦아 마무리하세요.

**보호 필름을 이용한 제품 취급**

- 조립하기 전에 원활한 조립을 위해 모서리와 표면에 붙어 있는 보호 필름을 제거해 주세요.
- 다른 보호 필름은 조립 중 손상을 방지하기 위해 남겨주세요. 조립 후 모든 보호 필름을 제거하세요.
- 주의 - 보호 필름을 제거한 직후 표면이 긁힘에 매우 민감할 수 있습니다.
- 긁힘을 방지하기 위해 부드러운 비누 용액으로 표면을 닦아주세요. (최대 1%, 알코올이나 연마제가 없는 성분).

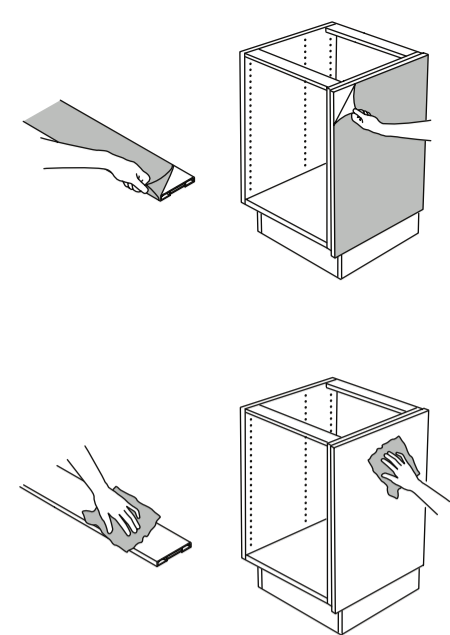

### Româna

Curăța cu o cârpă înmuiată în apă și detergent delicat, neabraziv, sau săpun, dacă este necesar. Șterge cu o cârpă uscată.

**Cum să folosești produse cu folie de protecție**

- Înainte de asamblare, scoate folia de protecție de pe margini și alte suprafețe care pot interfera cu asamblarea.
- Lasă restul foliei de protecție pentru a evita deteriorarea în timpul asamblării. După asamblare, scoate toată folia de protecție.
- Notă - suprafețele pot fi foarte sensibile la zgârieturi imediat după eliminarea foliei de protecție.
- Pentru a îmbunătăți rezistența la zgârieturi, șterge suprafețele cu o soluție de detergent delicat (max. 1%, fără alcool sau substanțe abrazive).



## Srpski

Čisti mekom krpom nakvašenom vodom i blagom neabrazivnom tečnošću za sude ili sapunom, po potrebi. Osuši čistom krpom.

**Kako da rukuješ proizvodima sa zaštitnom folijom**

- Pre sastavljanja, ukloni foliju s ivica i drugih površina koje mogu uticati na sastavljanje.
- Ostavi preostalu zaštitnu foliju da izbegneš oštećenja tokom sastavljanja. Po sastavljanju, ukloni zaštitnu foliju.
- Napomena — površine mogu biti posebno osetljive na ogrebotine neposredno posle uklanjanja zaštitne folije.
- Da dodatno poboljšaš otpornost na ogrebotine, prebriši površine blagim rastvorom sapuna (maks. 1%, bez alkohola i abraziva).

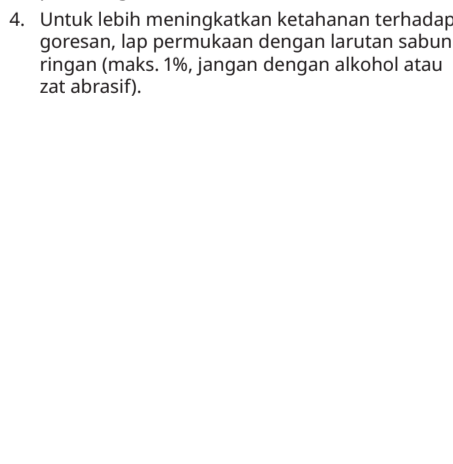

### Slovensky

V prípade potreby utrite mäkkou handričkou namočenou vo vode a jemným neabrazívnym čistiacim prostriedkom na umývanie riadu alebo mydlom. Utrite do sucha čistou handričkou

**Ako zaobchádzať s výrobkami s ochrannou fóliou**

- Pred montážou odstráňte ochranný film z hrán a iných povrchov, ktoré by mohli byť montážou prekryté.
- Zostávajúcu ochrannú fóliu ponechajte, aby sa pri montáži výrobok nepoškodil. Po montáži zvyšok ochrannej fólie odstráňte.
- Pozor, povrchy môžu byť okamžite po odstránení ochrannej fólie mimoriadne citlivé na poškriabanie.
- Aby ste zlepšili ich odolnosť proti poškriabaniu, utrite povrchy jemným mydlovým roztokom (max. 1%, bez alkoholu alebo drsných čističiek).



## Slovenščina

Očisti z mehko krpo, navlaženo z vodo, po potrebi lahko tudi z nežnim neabrazivnim čistilnim sredstvom. Obriši do suhega s čisto krpo.

**Kako ravnati z izdelki z zaščitno folijo**

- Pred montažo odstrani zaščitno folijo z robov in drugih površin, kjer lahko ta ovira montažo.
- Na preostalih mestih ne odstrani zaščitne folije, da se površina med montažo ne poškoduje.
- Pomni – takoj po odstranitvi folije je površina posebno občutljiva na praske.
- Za boljšo odpornost proti praskam površine prebriši z mehko krpo, navlaženo z blago milnico (največ 1% raztopino brez alkohola ali abrazivnih sredstev).

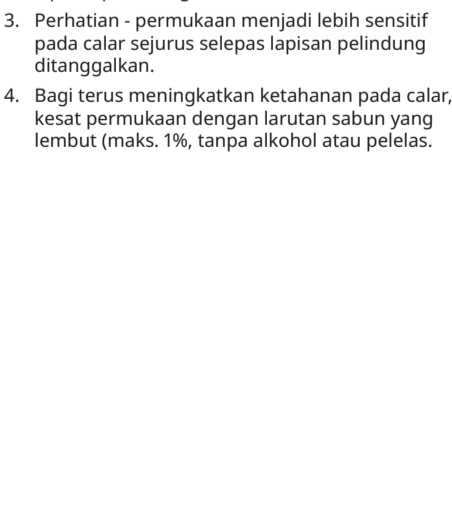
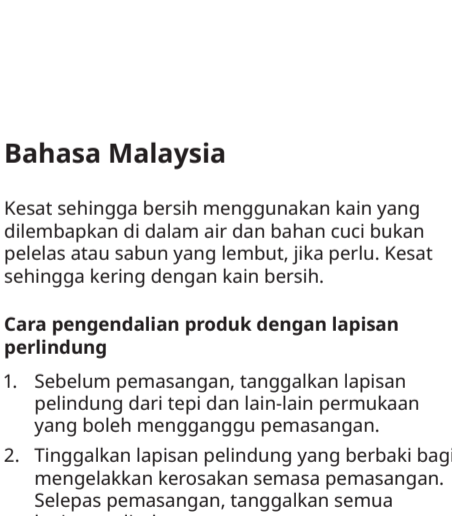

### Български

Ако е необходимо, почистете с кърпа навлажнена с вода и мек неабразивен препарат или сапун. После подсушете с чиста кърпа.

**Работа с продукти покрити с предпазно фолио**

- Преди да започнете сглобяването премахнете предпазното фолио от ъглите и от други повърхност, ако пречат на сглобяването.
- Оставете останалото предпазно фолио с цел защита от щети по време на сглобяването. Премахнете изцяло предпазното фолио след като сте приключили със сглобяването.
- Забележка - след като премахнете предпазното фолио някои повърхности могат да бъдат по-уязвими на надраскване.
- За да направите артикула по-устойчив на надраскване, избършете повърхностите с мек сапунен разтвор (макс. 1%, без алкохол или абразивни елементи).



### Türkçe

Suyla nemlendirilmis yumusak bir bez ve gerekirse hafif aşındırıcı olmayan bir deterjan veya sabunla silin. Temiz bir bezle kurulayın.

**Koruyucu film ile kullanımı**

- Montajdan önce, koruyucu filmi kenarlardan ve montaj engelleyebilecek diğer yüzeylerden çıkarın.
- Montaj sırasında hasar görmemesi için kalan koruyucu filmi bırakın. Montajdan sonra, tüm koruyucu filmi çıkarın.
- Not - koruyucu filmi çıkardıktan hemen sonra yüzeyler çiziklere karşı aşırı duyarlı olabilir.
- Çizilmelere karşı direnci arttırmak için, yüzeyleri yumuşak bir sabun çözeltisiyle silin (en fazla %1, alkol veya aşındırıcı madde içermemel).



### Hrvatski

Očistiti krpom natopljenom u blagi deterđzent za pranje ili sapun, po potrebi. Osušiti čistom krpom.

**Kako rukovati proizvodima sa zaštitnom folijom**

- Prije sastavljanja, skinuti zaštitni sloj s rubova ili ostalih površina koje mogu smetati pri sastavljanju.
- Ostaviti preostalu foliju radi izbjegavanja oštećenja nastalih tijekom sastavljanja. Nakon sastavljanja, skinuti svu zaštitnu foliju.
- Napomena – police mogu biti dodatno osjetljive na ogrebotine odmah po skidanju zaštitnog sloja.
- Za povećavanje otpornosti na ogrebotine, prebriši površine blagom sapunskom otopinom (maks. 1 %, bez alkohola ili abraziva).

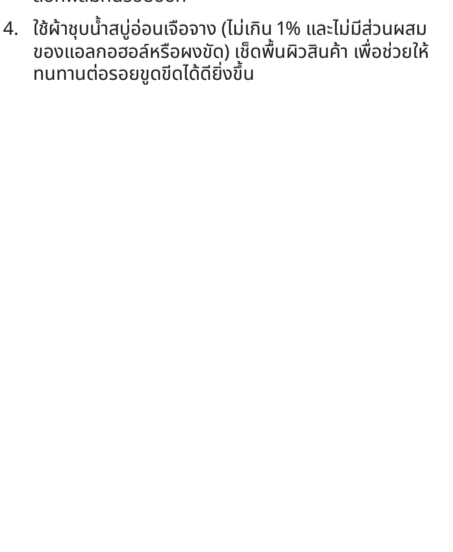
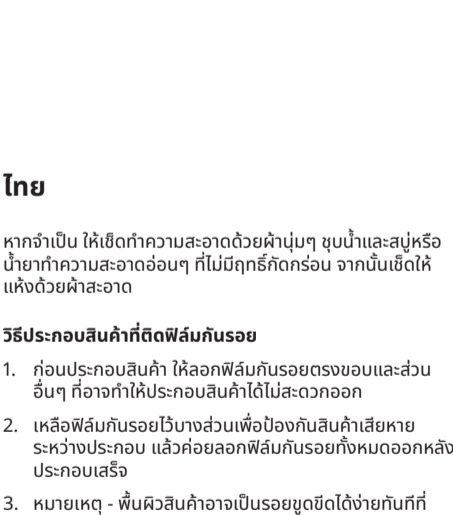
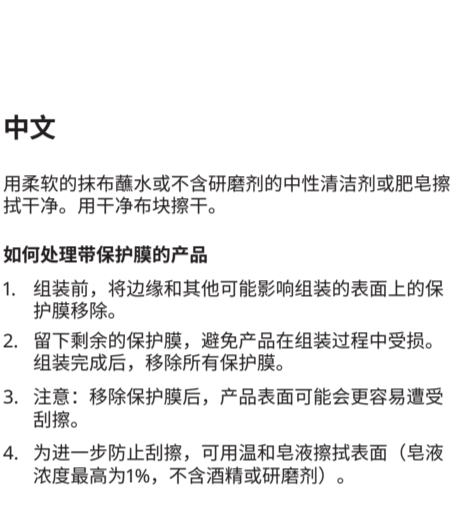

### Ελληνικά

Καθαρίστε με ένα μαλακό πανί μουσκεμένο σε νερό και ήπιο, μη διαβρωτικό απορρυπαντικό ή σαπούνι, αν είναι απαραίτητο. Σκουπίστε με ένα καθαρό και στεγνό πανί.

**Χρήση προϊόντων με την προστατευτική μεμβράνη**

- Πριν την συναρμολόγηση, αφαιρέστε την προστατευτική μεμβράνη από τις άκρες και από άλλες επιφάνειες που μπορεί να παρεμβαίνει στην συναρμολόγηση.
- Αφίρηστε την προστατευτική μεμβράνη που υπολείπεται για να προστατεύσετε την επιφάνεια κατά τη διάρκεια της συναρμολόγησης. Μετά την συναρμολόγηση αφαιρέστε όλη την μεμβράνη.
- Σημείωση-οι επιφάνειες μπορεί να είναι πολύ ευαίσθητες στις γρατσουνιές αμέσως μετά την αφαίρεση της μεμβράνης.
- Για να βελτιώσετε περισσότερο την αντοχή στις γρατσουνιές, καθαρίστε τις επιφάνειες με ένα ήπιο διάλυμα σαπουνιού (μέγ. 1%, χωρίς αλκοόλ ή διαλύτες).



## 繁體

用軟布沾水、不含研磨成分的溫和清潔劑擦拭乾淨，再用乾淨的布擦乾。

**如何在產品應用保護膜**

- 安裝前，請先移除邊緣及其他表面上會影響組裝的保護膜
- 保留剩餘的保護膜以免在安裝過程中受損；安裝後移除所有保護膜；
- 注意–移除保護膜後表面很容易被刮花
- 若要加強防刮能力，可用溫和的皂水(最多含1%或不含酒精或研磨劑)擦拭表面

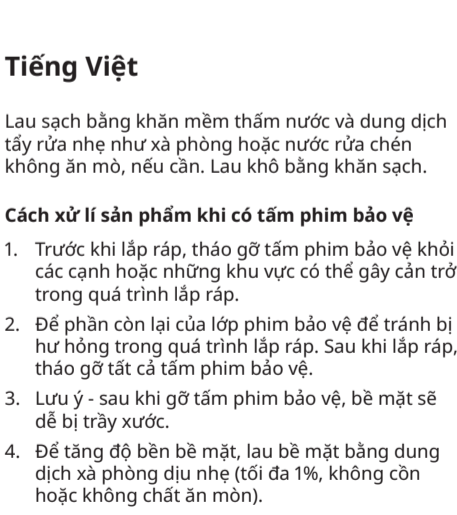
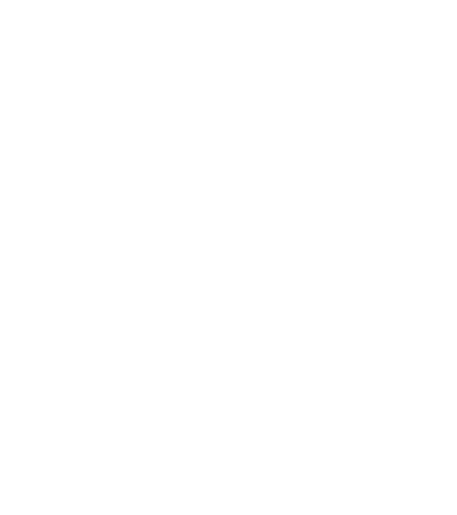
<sup>[1]</sup> Protřít m'jako vologoju gančirkou z m'jakim m'jinnm zasobom bez abrazivn'nych element'ov abo milom, jakčo potřbno. Vitřít nasucho